

MAIN CATALOG

PLC Automation

PLCs, Control Panels, Engineering Suite
AC500, CP600, Automation Builder



PLC Automation

PLCs, Control Panels, Engineering Suite

002–039	PLC Automation product family
040–053	Automation Builder Integrated engineering suite
054–071	AC500-eCo Entry level PLC solutions
072–119	AC500 High performance modular PLC
120–165	AC500-XC PLC operating in eXtreme Conditions
166–179	AC500-S Functional Safety PLC
180–191	CP600-eCo , CP600 and CP600-Pro Control panels
192–225	Application descriptions and additional information
226–229	Index

PLC Automation product family

Overview

ABB offers a comprehensive range of scalable PLCs and robust HMI control panels. Since its launch in 2006, the AC500 PLC platform has achieved significant industry recognition for delivering high performance, quality and reliability.

01

Comprehensive range

- ABB delivers scalable, flexible and efficient ranges of automation components to fulfill all conceivable requirements of the most diverse automation applications.
- ABB's automation devices deliver solutions with high performance and flexibility to be effectively deployed within various industries and applications including water, building infrastructure, data centers, renewable energy, machinery automation, material handling, marine and many more.

Engineering suite

- ABB Automation Builder is the integrated software suite for machine builders and system integrators requiring state-of-the-art productive machine and system automation.
- Combining the tools required for configuring, programming, debugging and maintaining automation projects from one common intuitive interface, Automation Builder addresses the largest single cost element of most of today's industrial automation projects - software.

Programmable Logic Controllers PLCs

- The AC500, AC500-eCo, AC500-S and AC500-XC scalable PLC ranges provide solutions for small, medium and high-end applications.
- Our AC500 PLC platform offers different performance levels and is the ideal choice for high availability, extreme environments, condition monitoring, motion control or safety solutions.
- Our AC500 PLC platform offers interoperability and compatibility in hardware and software from compact PLCs up to high end and safety PLCs.

Control panels

- CP600-eCo and CP600 HMI control panels offer a wide range of features and functionalities for maximum operability.
- ABB control panels are distinguished by their robustness and easy usability, providing all the relevant information from production plants and machines at one single touch.

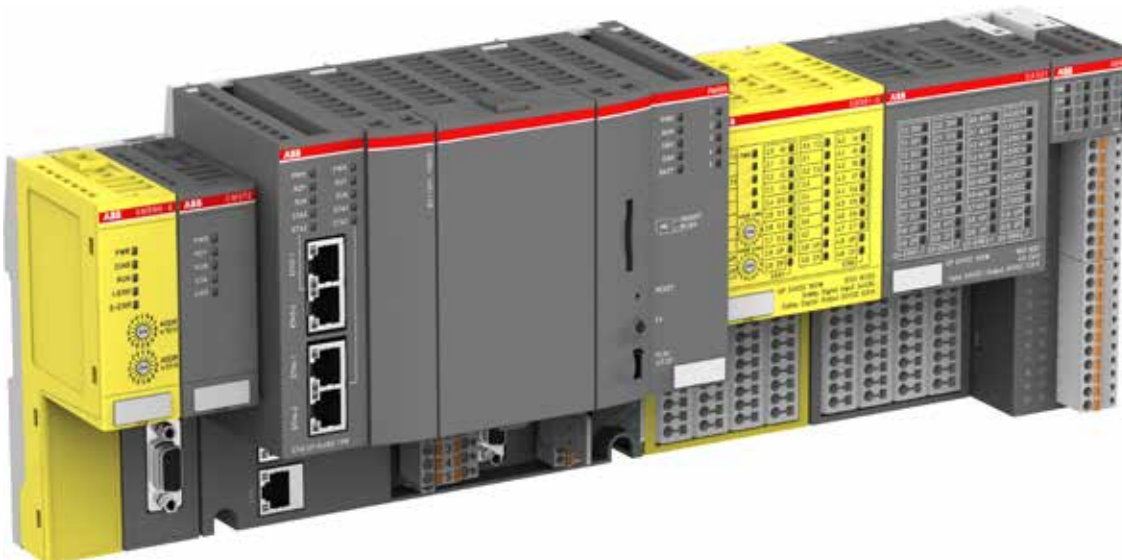

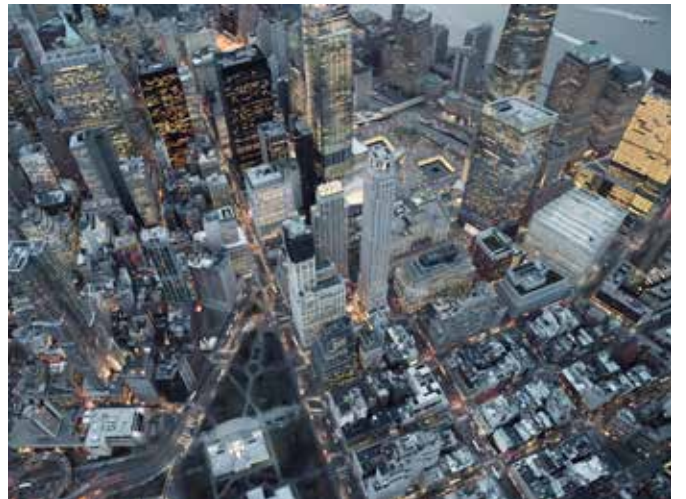

PLC Automation product family

Overview

01

Engineering suite



Automation Builder

- Automation Builder connects the engineering tools for PLC, safety, control panels, SCADA, drives and motion.
- Automation Builder combines the tools required for configuring, programming, debugging and maintaining automation projects from one common intuitive interface.



Library packages

- For efficient engineering of demanding applications.
- Easy-to-use application examples.

Visualization



CP600-eCo

- The economical CP600-eCo control panel is aimed for standard functions and high usability for clear interaction with the operation process.

Programmable Logic Controllers PLCs



AC500-eCo

- Compact PLC offering optimally suited flexible and economical configurations for automation solutions in smaller applications.
- ABB's AC500-eCo has been designed to integrate seamlessly into the broader AC500 PLC platform.

I/O modules



S500-eCo

- Range of modular I/Os for economical configurations in smaller applications.
- The I/O modules can be connected directly to the AC500 or AC500-eCo CPU modules.
- S500-eCo I/O modules can be mixed with standard S500 modules and also used as remote I/O with fieldbus communication interface modules.



CP600

- The robust CP600 HMI provides high visualization performance, versatile communication and representative design for machines and systems.



CP600-Pro

- The CP600-Pro HMI portfolio comes with high end visualization performance, multi-touch operation, versatile trendsetting communication and representative design.



AC500

- Powerful PLC featuring a wide range of performance, communications and I/O capabilities for industrial applications.
- The ideal choice for complex, high-speed machinery and networking solutions.



AC500-XC

- Extreme condition PLC variant of the AC500 platform.
- With extended operating temperature, immunity to vibration and hazardous gases, use at high altitudes and in humid environments.



AC500-S

- Integrated safety PLC (SIL3, PL e) designed for safety applications involved in factory, machinery or process automation area.
- For complex safety solutions.



S500

- Modular I/O assortment with protected outputs and comprehensive diagnosis, covering a wide range of signal types.
- The I/O modules can be installed as remote I/O with a communication interface module or be directly connected to the AC500 CPU.
- Support of different fieldbuses makes it possible to use the S500 I/O modules with PLCs from different manufacturers.



S500-XC

- Extreme condition variant of the S500 I/O system.
- With extended operating temperature, immunity to vibration and hazardous gases, use at high altitudes and in humid environments.



S500-S

- Safety variant of the S500 I/O system.
- Extreme condition variants available.

PLC Automation product family

Connectivity

01

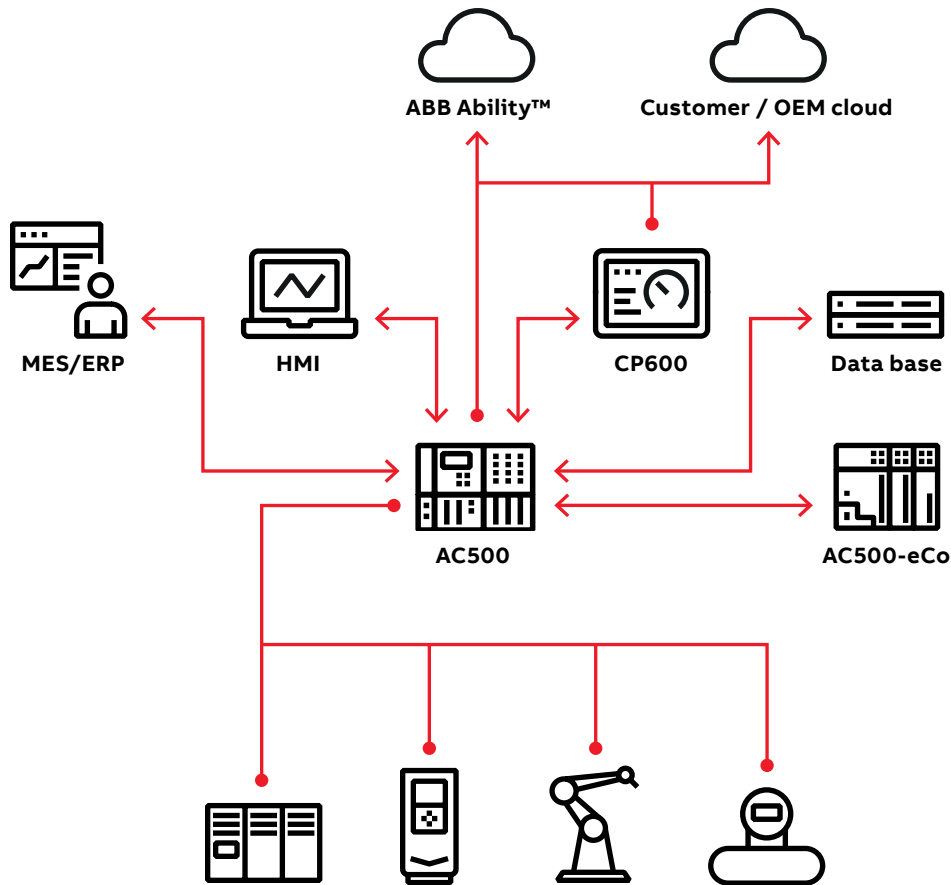

IT network / internet

- OPC UA
- HTML(S)
- FTP(S)
- SNTP

Factory/site network

- OPC DA/AE
- OPC UA
- UDP
- TCP/IP
- BACnet
- MySQL / MSSQL
- HTML(S)
- FTP(S)
- SNTP
- SNMP

Control network

- PROFINET
- EtherCAT
- Modbus TCP
- Modbus RTU
- Profibus DP
- IEC 60870-5-104
- IEC 61850

Protocol	Application example
OPC UA	SCADA and cloud connectivity: Give access to selected AC500 variables and objects
HTTP(S)	Publish HTML5 websites for monitoring and control
HTTP Request	Request information like temperature, humidity etc. from devices with web server functionality
Connector to SQL Database	Save to or get data from MSSQL or MySQL databases
SNMP Agent	Send traps (up to 4096 process alarms per PLC) to a SNMP management tool
SNMP Manager	Act as a SNMP Manager with Set and Get commands
BACnet	Give access to selected AC500 variables and objects
UDP and TCP/IP	Implement specific and efficient own communications
FTP(S)	Server and client for secure and efficient exchange of big data



PLC Automation product family

Network architecture

01

Communication with AC500 – the perfect solution

Flexibility, real-time capability and maximum data transfer speed are just some of the communication demands automation systems must meet. With the AC500, ABB has developed a communication platform offering customer-oriented solutions for the most diverse communication tasks. Simple network configuration and diagnostics options using Automation Builder enable ease of planning, implementation and commissioning thus saving engineering time and project costs. Among others, ABB's AC500 supports the following communication protocols:

PROFIBUS DP

PROFIBUS DP delivers flexible configuration by means of a mono- and multi-master system structure and data transfer rates of up to 12 Mbit/s with twisted pair cables and/or optical

fibers. PROFIBUS DP allows for the connection of up to 126 devices (master/slave) to one bus segment thus enabling simple and reliable communication solutions.

PROFINET

PROFINET I/O meets the stringent requirements for real time Ethernet protocols in the world of automation. Very fast data transfer, integrated and standardized network structures from controller to field and flexible network management support users in the implementation of their automation solutions.

CANopen

With up to 127 participants and transmission speeds of 10 kbit/s up to 1 Mbit/s depending on bus length, CANopen offers high-speed data transfer and high immunity in master/slave network topologies.

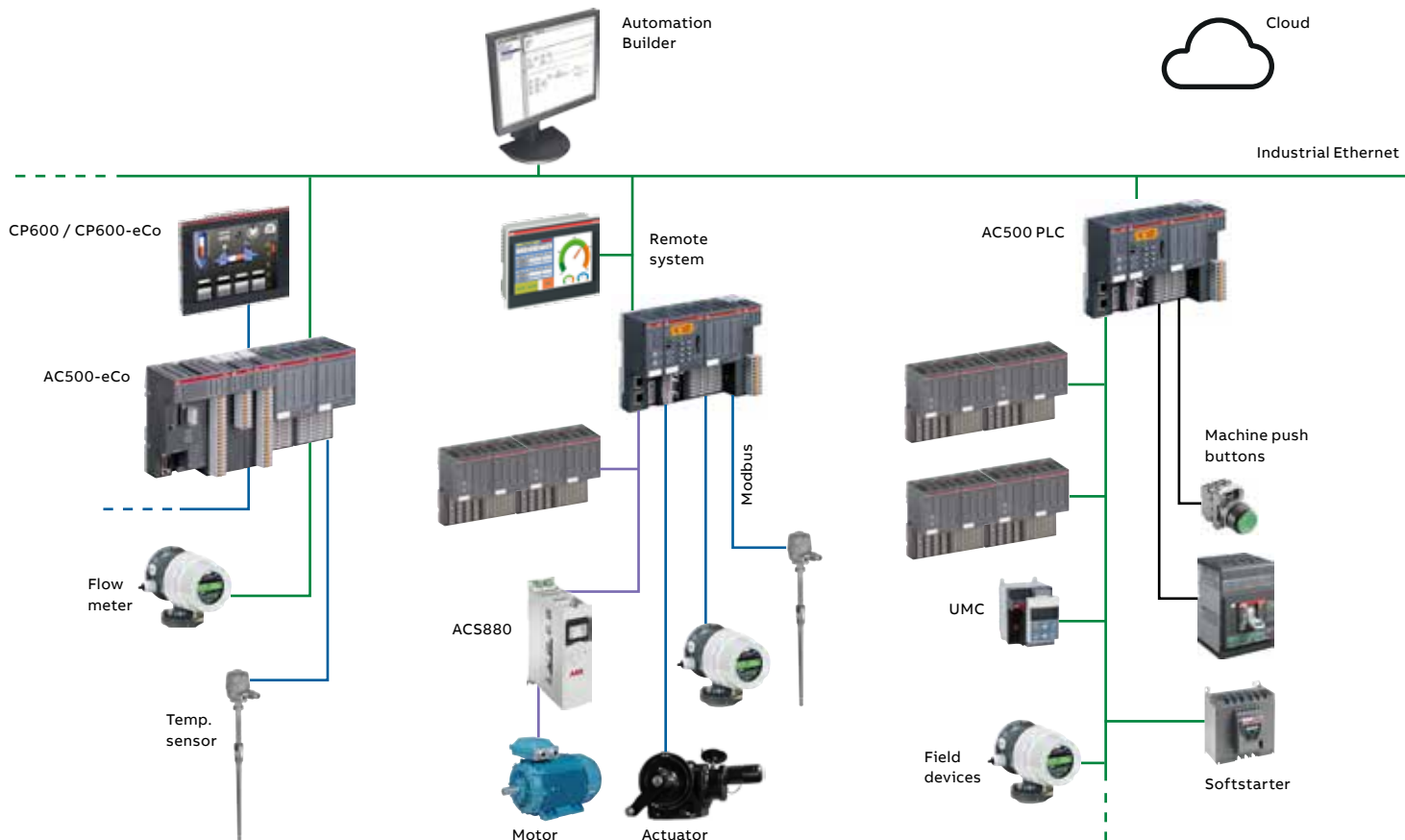

CS31-Bus and RCOM

CS31-Bus is a high-performance, proprietary ABB communication standard featuring data transfer speeds of up to 187.5 kbit/s and enabling up to 31 bus participants to communicate via RS485, simple telephone cable or optical fiber. RCOM is a proprietary ABB bus protocol for master/slave communication via RS232/485. Expandable to 254 RCOM slaves.

Modbus TCP & RTU

Modbus RTU is an open serial data protocol for master/slave networks of up to 31 network nodes. Different bus lengths depending on the type of serial communication interface enable data transfer speeds of up to 115.2 Kbit/s. Modbus TCP is a common Ethernet-based network protocol.

Ethernet and Internet

Integrated communication, high data transfer rates and the use of existing data networks enable simple, customer-specific solutions. Supported protocols are:

- HTTP for web server. Visualization for remote operation and maintenance
- FTP for data file transfer
- Simple Network Time Protocol (SNTP) offering PLC time synchronization using Internet-hosted time services
- SMTP for e-mails with attachments

- TCP and UDP ports programmable for project-specific protocols. Library functions available.
- IEC60870-5-104 telecontrol, mainly used for pipelines, water and waste-water. Suitable for protocol configuration with the Automation Builder software suite.
- DHCP for automatic IP address allocation
- PING for checking the connection with other automation devices

EtherCAT

EtherCAT is an open Industrial Ethernet standard certified according to international standards IEC 61158, IEC 61784 and ISO 15745-4. Thanks to extremely high data transfer speeds, EtherCAT can serve as real time Ethernet protocol for time critical motion control applications. Whether for "cam switch" functionalities or diverse master/slave network configurations, AC500 delivers the perfect solution for your application.

BACnet

An object oriented open Infrastructure and Building Automation protocol supported by a Server Library (B-ASC) for OEM and project use cases.

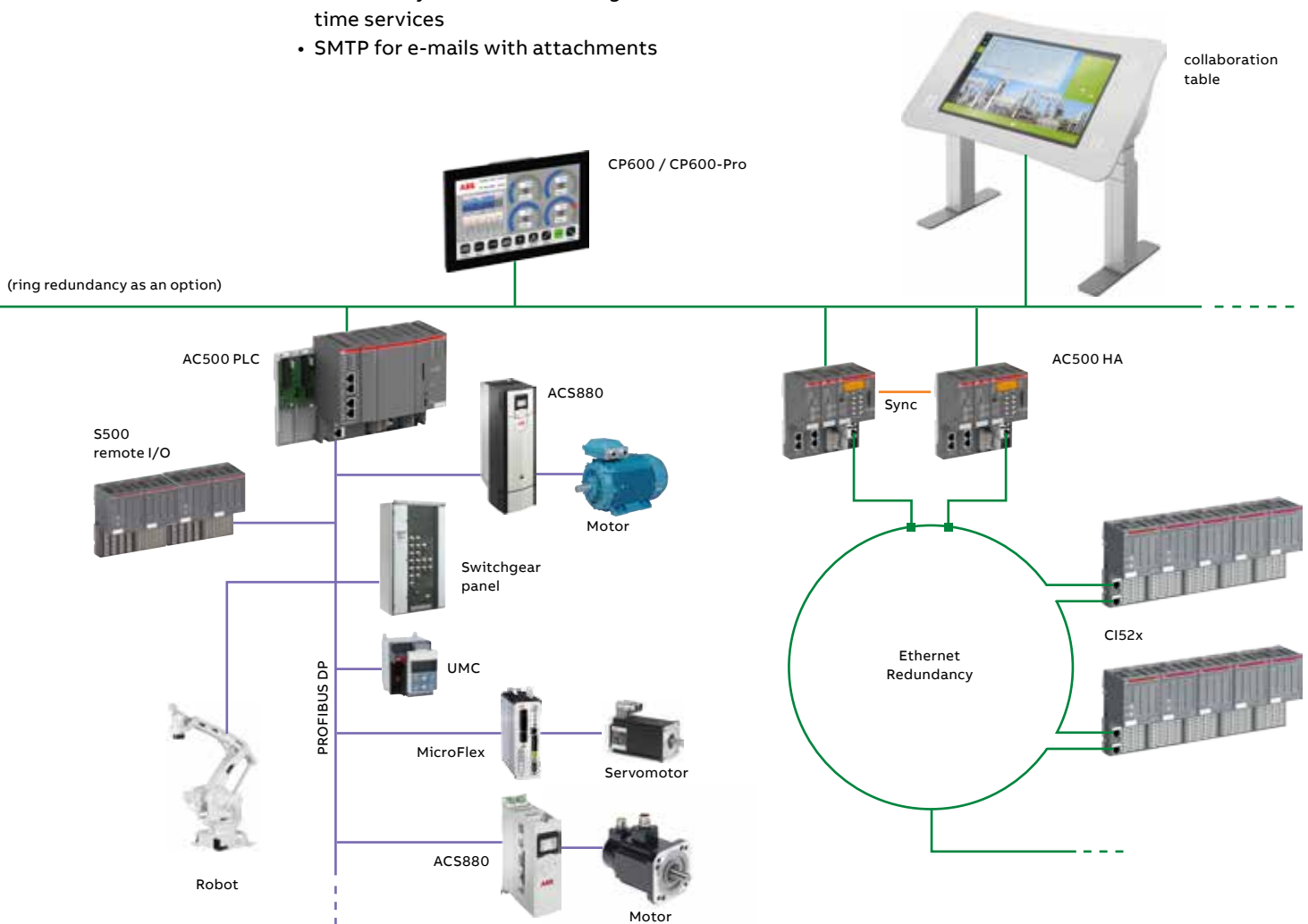

PLC Automation product family

Automation Builder

Engineering Productivity for Machine Builders and System Integrators.

01



Product license options

	Automation Builder Basic	Automation Builder Standard	Automation Builder Premium
Free	●		
AC500-eCo	●	●	●
AC500 with local I/O & network (1)	●	●	●
AC500 with fieldbus (2)		●	●
AC500-S Safety		○	○
Drive Manager		●	●
Drive application programming (3)	●	●	●
Motion programming	● (4)	●	●
Panel Builder 600	○	●	●
Panel Builder 600 Basic	●	●	●
Integrated engineering (5)		●	●
Productivity features (6)			●
Additional features (7)			○

- fully
- partly

(1) TCP protocols, Modbus, IEC60870-5-104, CS31

(2) PROFIBUS, PROFINET, EtherCAT, CAN

(3) Drive application programming for drives with embedded PLCs. Drive Composer pro license included in Standard and Premium Edition.

(4) No Fieldbus connectivity in Automation Builder Basic

(5) PLC, Safety, Panel, Drive, Motion, SCADA

(6) C/C++, ECAD data exchange, CSV interface extensions, project compare

(7) Virtual Commissioning Platform for virtual system testing, Professional Developer Tools for system design, management, analysis, optimization and test

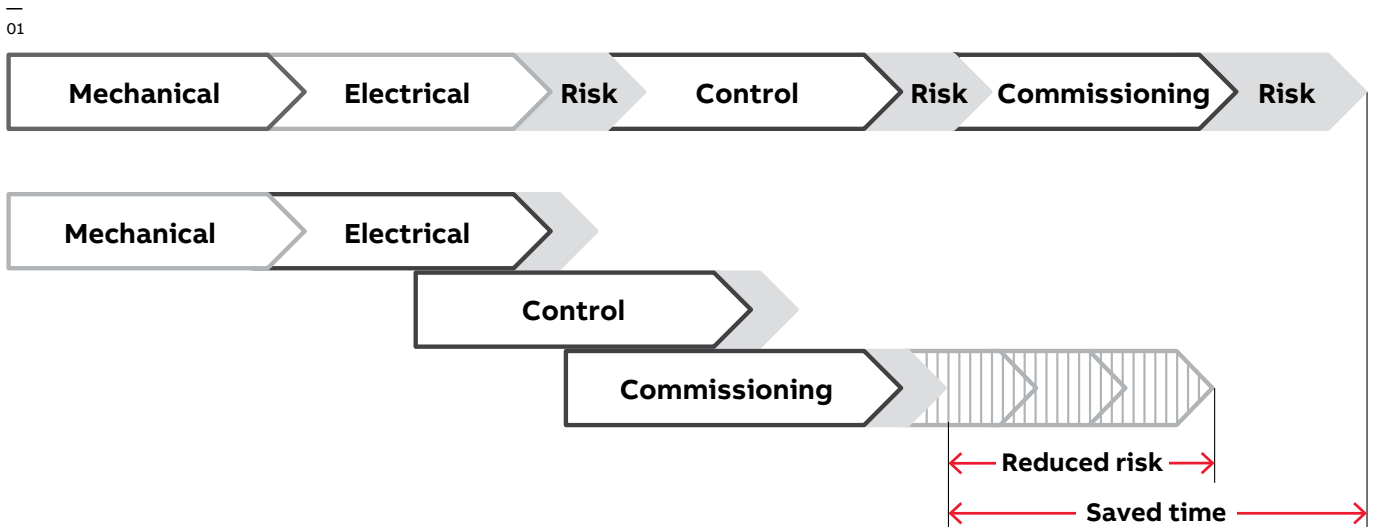

01

—
01 Streamline and simplify your engineering process: Reduce risk and save time.

Discover engineering productivity when engineering your discrete automation solutions

Automation Builder is ABB's integrated programming, maintenance and simulation environment for PLCs, safety, drives, motion, control panels and SCADA.

Automation Builder combines the proven ABB tools Drive Manager, Mint WorkBench, Panel Builder and succeeds Control Builder Plus.

The Automation Builder minimizes your efforts for project code and data administration

Improve your productivity with seamless engineering, common data storage, a single project archive, time-saving library blocks for device integration, and one common software installer.

Reduce engineering efforts and maintenance costs using easy-to-use libraries for wind, water, solar, drives, motion, robotics, safety and building automation applications.

Easily create a connected world

Configure and program various devices in one single project. The integration of ABB's Automation Builder 2.0 and zenon software makes it easier than ever to develop effective automation solutions and unlock the potential of the Internet of Things (IoT).

Next level engineering productivity

Automation Builder 2.1 comes with fully integrated AC500 V3 configuration and application programming support including online diagnosis. Benefit from the extended scope of the ECAD interface, now also supporting EtherCAT and AC500 V3 devices.

Furthermore communication interface devices for Modbus TCP can be directly configured by Automation Builder without needing a PLC.

Virtual commissioning – a game changer in engineering

Simulate and automate all kinds of applications with minimum effort. Test the complete system seamlessly before involving real hardware. Even complex systems can be built up quickly and efficiently, ensuring smooth interaction of all components, as well as high reliability and system safety.

Download Automation Builder from www.abb.com/automationbuilder

Familiarize with Automation Builder using a 30 days test license.

PLC Automation product family

AC500 libraries

A good investment for system integrators and end-users, AC500 libraries improve stability while reducing warranty costs and service. Library packages contain easy-to-use examples for minimal programming effort and quick implementation of complex and demanding applications.

01





AC500 libraries deliver the seamless integration of PLCs, drives and HMI for the quick and easy building and commissioning of automation solutions. AC500 solution libraries by ABB are maintained to ensure that your programs can also be used with less risk.

Motion control library

Library package for decentral, central and coordinated motion according to the PLCopen standard.

Solar library

Library package for solar trackers increasing energy efficiency, providing quick commissioning and excellent positioning accuracy.

Water library

Library package with energy efficiency functionalities offering quick commissioning of water applications, such as pump stations with remote communication.

Drive integration library

Library package for the quick integration of ABB ACS drives using different fieldbusses.

Temperature control library

Library package for the advanced PID temperature control of demanding applications, for example extrusion.

BACnet library

Library package adds BACnet-ASC Device Profile for communication to BMS Building Management Systems in larger infrastructure projects.

HA-Modbus TCP library

Library package adds High Availability System functionality for redundant hot standby over Ethernet field network via Modbus TCP.

PLC Automation product family

PLCs at a glance...

AC500 Programmable Logic Controllers with scalable, state-of-the-art technology for better performance.

01

Standard industrial communication fieldbus, network and protocols supported by the 'One Platform' solution make the AC500 the perfect automation solution in even the most demanding

environments. Flexible and scalable superior CPUs deliver performance whenever and wherever you need it.

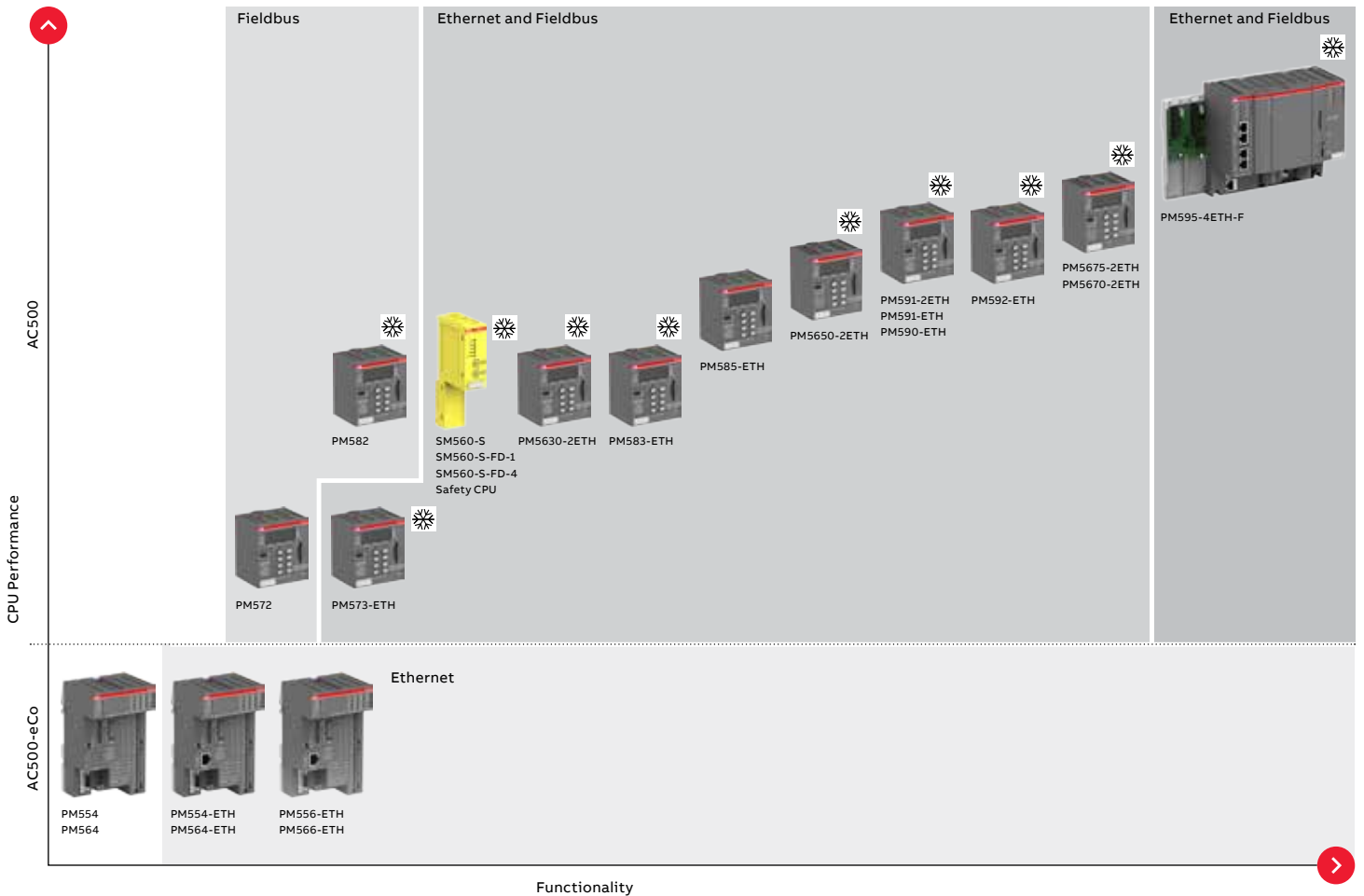

- Ethernet enabled
- Fieldbus enabled
- Ethernet, Fieldbus and High Availability enabled
- Ethernet, Fieldbus, High Availability and enlarged memory
- eXtreme Conditions version available

	AC500-eCo	AC500	AC500 V3	AC500-XC AC500-XC V3	AC500-S (2)	AC500-S-XC (2)
System Configuration and Application programming						
Automation Builder (common programming tool)	●	●	●	●	●	●
Application Features						
Extended temperature range				●		●
Functional safety			● (5)		●	●
Support of simple motion with FM562 module (1)	●	●	● (3)(5)	●	●	●
Support of coordinated motion (1)		●	● (3)(5)	●	●	●
Support of High Availability (HA)		●	●	●		
CPU Features						
	AC500-eCo	AC500	AC500 V3	AC500-XC AC500-XC V3	AC500-S (2)	AC500-S-XC (2)
Performance (time per binary instruction)	0.08 μs	0.0006...0.06 μs	0.001...0.02 μs	0.0006...0.06 μs	0.05 μs	0.05 μs
Program memory	128...512 kB	128 kB...16 MB	8...160 MB	128 kB...160 MB (8)	1...1.3 MB	1...1.3 MB
User data memory	14...130 kB	128 kB...16 MB		128 kB...160 MB (8)	1024 kB	1024 kB
Remanent data (= saved)	2 kB	12 kB...3 MB	256 kB ... 1.5 MB	12 kB...3 MB	120 kB	120 kB
Serial communication						
RS232		●	●	●	●	●
RS485	●	●	●	●	●	●
Isolated interface		●	●	●	●	●
CAN communication interface						
CANopen Master, J1939 and CAN 2A/2B protocols			●	●		
Ethernet features on CPU with integrated Ethernet or external communication module						
Online access (Programming)	●	●	●	●	●	●
ICMP (Ping), DHCP, IP configuration protocol	●	●	●	●	●	●
UDP data exchange, Modbus TCP	●	●	●	●	●	●
Ethernet features on CPU with integrated Ethernet only						
HTTP / HTTPS (integrated web server)	● / -	● / -	● / ●	● / ●	● / -	● / -
HTML 5			●	●		
SNTP (Time synchronization)	●	●	●	●	●	●
FTP / FTPS server	● / -	● / -	● / ●	● / ●	● / -	● / -
FTP client	● (7)	● (7)	●	● (7)	● (7)	● (7)
SMTP client (Simple Mail Transfer Protocol)	○	●	● (5)	● (5) for V3	●	●
IEC 60870-5-104 remote control protocol		●	●	●	●	●
network variables on UDP			●	●		
Socket programming		●	●	●	●	●
OPC DA (AC500 V2 and V3)	●	●	●	●	●	●
OPC UA server (AC500 V3 only)			●	●		
BACnet (B-ASC profile)	○ (4)	● (4)		● (4)	● (4)	● (4)
Selectable protocol						
EtherCAT Master		● (6)	● (4)(5)	● (4)(5)(6)		
PROFINET IO Controller		● (6)	● (4)(5)	●		
EthernetIP Adapter			● (4)(5)	● (4)(5)		
IEC 61850 protocol (MMS Server, GOOSE)			●	●		
RTV (Remote Target Visu)			● (4)	● (4)		
Capability to connect Fieldbus Modules		●	●	●	●	●
I/Os integrated on CPU	●					
I/O Modules Features						
	S500-eCo	S500	S500	S500-XC	S500-S (2)	S500-S-XC (2)
Analog modules						
Configurable		●	●	●		
Dedicated	●				●	●
Digital modules						
Configurable	○	●	●	●		
Dedicated	●	●	●	●	●	●
Transistor outputs short circuit protected		●	●	●	●	●
Output diagnosis		●	●	●	●	●
Extension with S500-eCo and S500(-XC) I/O modules	●	●	●	●	● (2)	● (2)

● fully

○ partly

(1) Requires Library PS552-MC-E

(2) AC500-S and AC500-S-XC are extension CPU modules. They require an AC500 or AC500-XC CPU to operate. The latter supports all communication interfaces.

(3) Requires new V3 Library

(4) Licensed features

(5) In development

(6) PM595 and/or CPU V3 only

(7) Application library download from "application examples"

(8) Memory size is complete size for program and data with AC500 V3 CPU

PLC Automation product family

CPU Selector

	AC500-eCo		AC500	
	PM5x4	PM5x6	PM57x	PM5630 V3
What does your project need?				
Basic				
Compactness and onboard I/Os ?	●	●	○	○
230 V AC power supply onboard ?	●	●	○	○
Standard operational temperature ?	●	●	●	●
Extreme environmental conditions (e.g. high temperature, humidity or vibrations) ?	-	-	●, (XC)	●, (XC)
Functional Safety up to SIL3 ?	○	○	●	○ / ● (1)
Application feature				
Simple motion with PTO ?	●	●	●	●
High-speed motion or interpolated motion ?	-	-	-	-
Data logging ?	-	-	-	○
Condition monitoring CMS ?	-	-	-	-
High availability with CS31 protocol ?	-	-	○	-
High availability with Ethernet Modbus TCP protocol ?	-	-	○	●
HTML5 web server ?	-	-	-	●
Telecontrol with IEC 60870-5-104 ?	-	-	○	●
Application performance				
More than 1 Cyclic and 1 Interrupt IEC61131 Task ?	○	○	●	●
4 or more IEC61131 Tasks ?	-	-	-	○
More than 2 kB retain variables ?	-	-	●	●
User program / User memory ?	128KB/14KB	512KB/130KB	512KB/512KB	8MB (2)
Large flash disc for data collecting ?	-	-	-	○
Web server data ≤ 1MB ?	●	●	●	○
Web server data ≥ 4MB ?	-	-	-	see above (2)
Floating point arithmetic calculation ?	-	-	-	●
Number of Ethernet Sockets for parallel connection ?	≤ 13	≤ 13	≤ 13	Unlimited (3)
Number of Modbus TCP Sockets (part of Ethernet Sockets) ?	≤ 12	≤ 12	≤ 12	Max. 40 (5)
CPU performance (ns per bit instruction) ?	80ns	80ns	60ns	20ns
Communication/Fieldbus				
Decentralized I/Os or communication on serial CS31 fieldbus ?	●	●	●	-
Decentralized I/Os or communication on serial Modbus RTU fieldbus ?	●	●	●	●
Decentralized I/Os or communication on PROFIBUS DP master / slave fieldbus ?	-	-	● / ●	● / ● (1)
Decentralized I/Os or communication on CAN/CANopen master / slave fieldbus ?	-	-	● / ●	● / ●
Decentralized I/Os or communication on Modbus TCP network ?	●	●	●	●
Decentralized I/Os or communication on PROFINET IO controller / device network ?	-	-	● / ●	● / ●
Decentralized I/Os or communication on EtherCAT master network ?	-	-	●	●
Two or more onboard Ethernet interfaces ?	-	-	-	●
Onboard selectable protocols PROFINET IO / EtherCAT / EthernetIP ?	-	-	-	● / ● / ● (1)(4)
IEC61850 MMS / GOOSE protocol ?	-	-	-	○ (4)
OPC UA server?	-	-	-	●

- Not possible

○ Possible but not optimal solution

● Possible with additional devices

● Possible and best selection

(1) In preparation

(2) Total memory for code, data and web server

(3) Number of ETH Socket total is basically not limited, but depends on: CPU load, priority of application tasks, kind of used protocols, amount of data transferred, network structure

(4) Feature(s) is (are) licensed

(5) Number of Modbus TCP Socket total today limited, check online for pdf catalog or actual FW release notes for status changes

PM58x	PM585-ETH	PM5650 V3	PM59x-ETH	PM591-2ETH	PM5670 V3	PM592-ETH	PM5675 V3	PM595-4ETH
●	●	●	●	●	●	●	●	●
○	○	○	○	○	○	○	○	○
●	●	●	●	●	●	●	●	●
●, (XC)	-	●, (XC)	●, (XC)	●, (XC)	●, (XC)	●, (XC)	●, (XC)	●, (XC)
●	●	○/●(1)	●	●	○/●(1)	●	○/●(1)	●
●	●	●	●	●	●	●	●	●
-	●	-	●	●	-	●	-	●
○	○	●	●	●	●	●	●	●
-	-	-	-	-	-	●	-	-
●	●	-	●	●	-	●	-	●
○	●	●	●	●	●	●	●	●
-	-	●	-	-	●	-	●	-
○	○	●	●	●	●	●	●	●
●	●	●	●	●	●	●	●	●
○	●	●	●	●	●	●	●	●
●	●	●	●	●	●	●	●	●
1MB/1MB	1MB/2MB	80MB (2)	2-4MB/2-4MB	4MB/4MB	160MB (2)	4MB/4MB	160MB (2)	16MB/16MB
○	○	○	○	○	○	4GB	8GB	4GB
○	○	○	○	○	○	○	○	○
4MB	4MB	see above (2)	8MB	8MB	see above (2)	8MB	see above (2)	16MB
-	●	●	●	●	●	●	●	●
≤ 22	≤ 29	Unlimited (3)	≤ 29	≤ 61	Unlimited (3)	≤ 29	Unlimited (3)	≤ 61
≤ 12	≤ 12	> 40 (5)	≤ 12	≤ 28	> 40 (5)	≤ 12	> 40 (5)	≤ 28
50ns	4ns	10ns	2ns	2ns	2ns	2ns	2ns	0.6ns
●	●	-	●	●	-	●	-	●
●	●	●	●	●	●	●	●	●
●/●	●/●	●/●(1)	●/●	●/●	●/●(1)	●/●	●/●(1)	●/●
●/●	●/●	●/●	●/●	●/●	●/●	●/●	●/●	●/●
●	●	●	●	●	●	●	●	●
●/●	●/●	●/●	●/●	●/●	●/●	●/●	●/●	●/●
●	●	●	●	●	●	●	●	●
-	-	●	-	●	●	-	●	●
-	-	●/●/●(1)(4)	-	-	●/●/●(1)(4)	-	●/●/●(1)(4)	●/●/-
-	-	●(4)	-	-	●(4)	-	●(4)	-
-	-	●	-	-	●	-	●	-



AC500-eCo



AC500



AC500-XC



AC500-S



AC500-S-XC

PLC Automation product family

AC500-eCo – modular concept

01

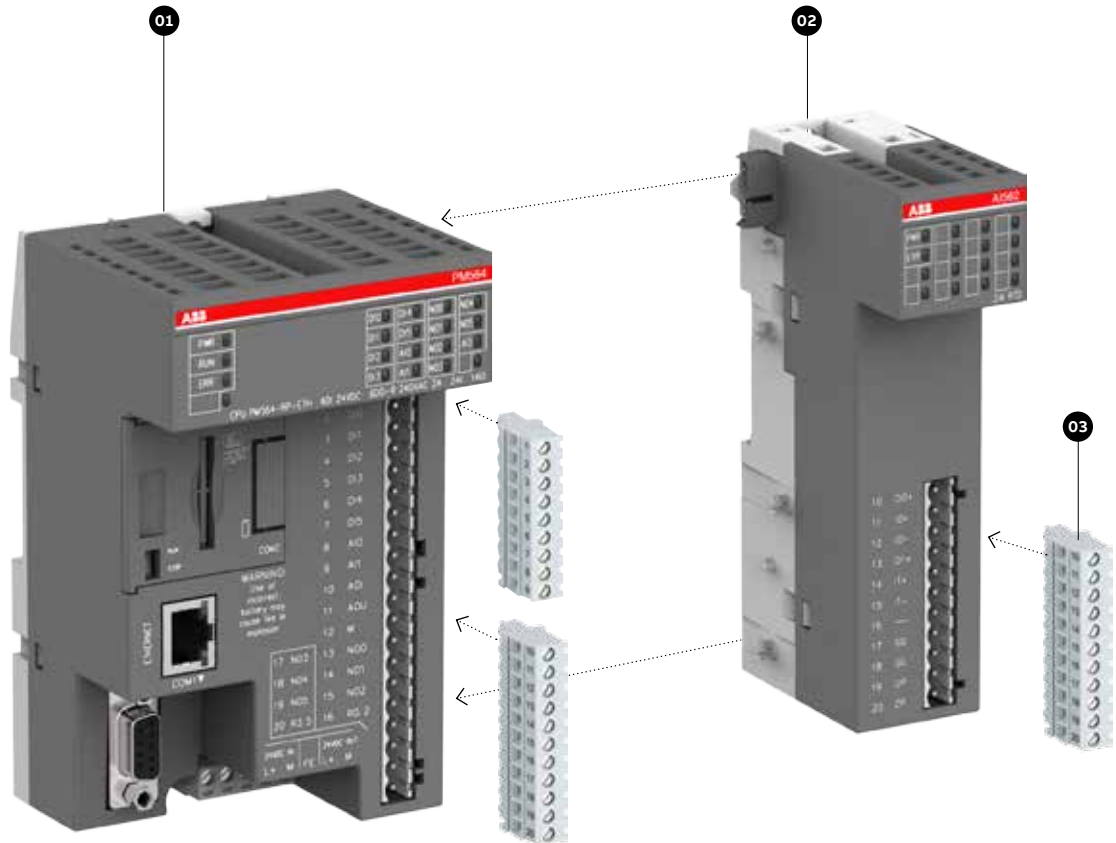

01 – AC500-eCo central processing unit (CPU)

- Different memory options
- Integrated communication option.

02 – S500-eCo I/O modules

- Up to 10 expansions
- Decentralized extension available.

03 – Terminal blocks

- Three types of pluggable terminal blocks available.

PLC Automation product family

AC500 and AC500-XC – modular concept

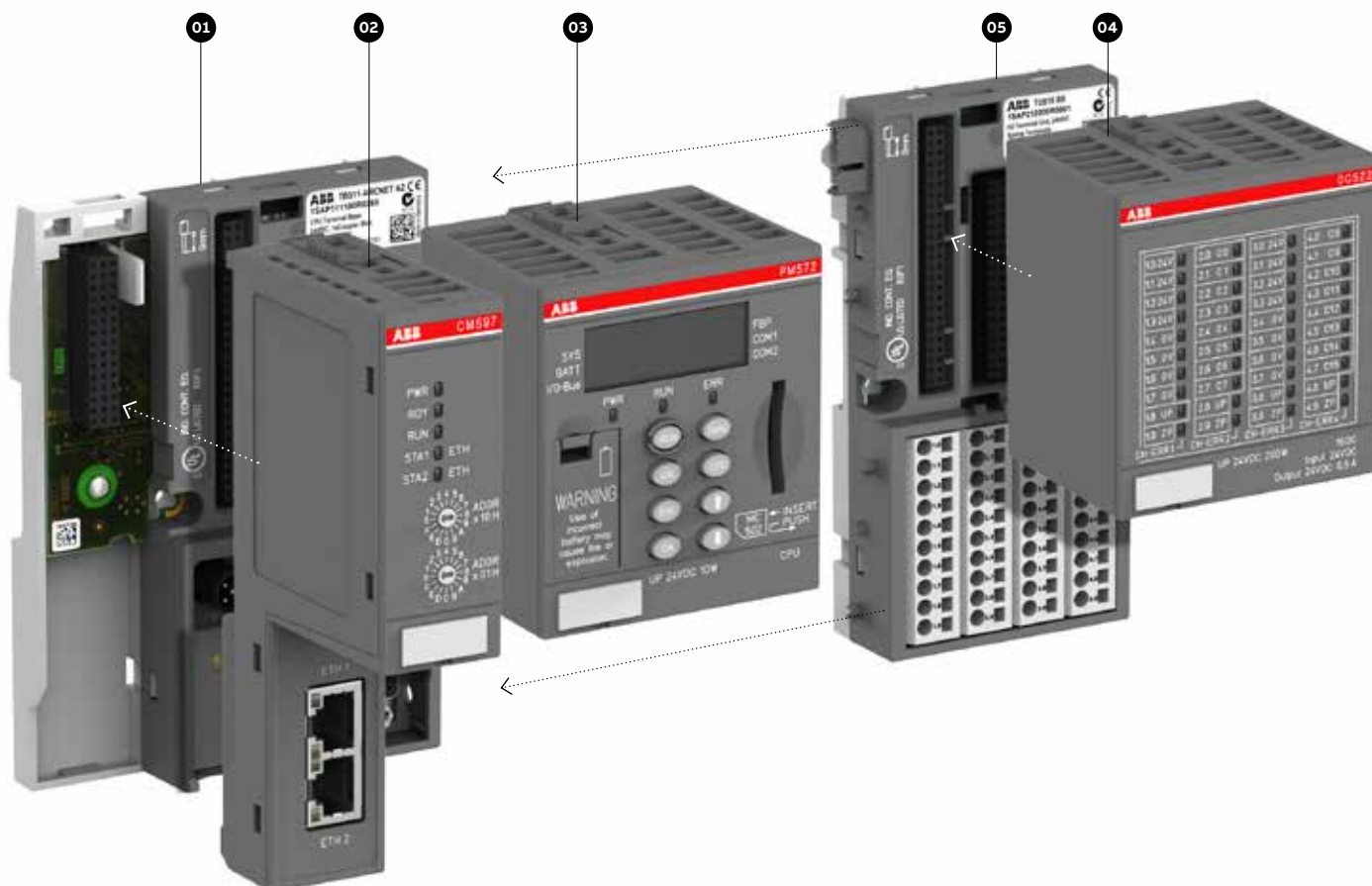

01

01 – Terminal base

- Common for all AC500 CPU types
- For 1, 2 or 4 communication modules
- With serial interfaces
- With 1 or 2 Ethernet interfaces
- New specific terminal base only for AC500 V3 CPU with 2 Ethernet interfaces and CAN interface.

02 – Communication modules

- For PROFIBUS DP, Ethernet, Modbus TCP, EtherCAT, CANopen, PROFINET IO or serial programmable
- Up to 4 pluggable.

03 – AC500 central processing unit (CPU)

- Different performance, memory, network, operating conditions options
- Integrated communication
- New AC500 V3 CPU with large memory and high performance (requires new specific terminal base).

04 – S500 I/O modules

- Up to 10 expansions
- Decentralized extension available.

05 – Terminal units

- Up to 10 terminal units
- Decentralized extension available.

PLC Automation product family

AC500-eCo system characteristics

Locally, AC500-eCo CPUs are expandable with up to 10 I/O modules.
 AC500-eCo CPUs with different performance levels are available.

01

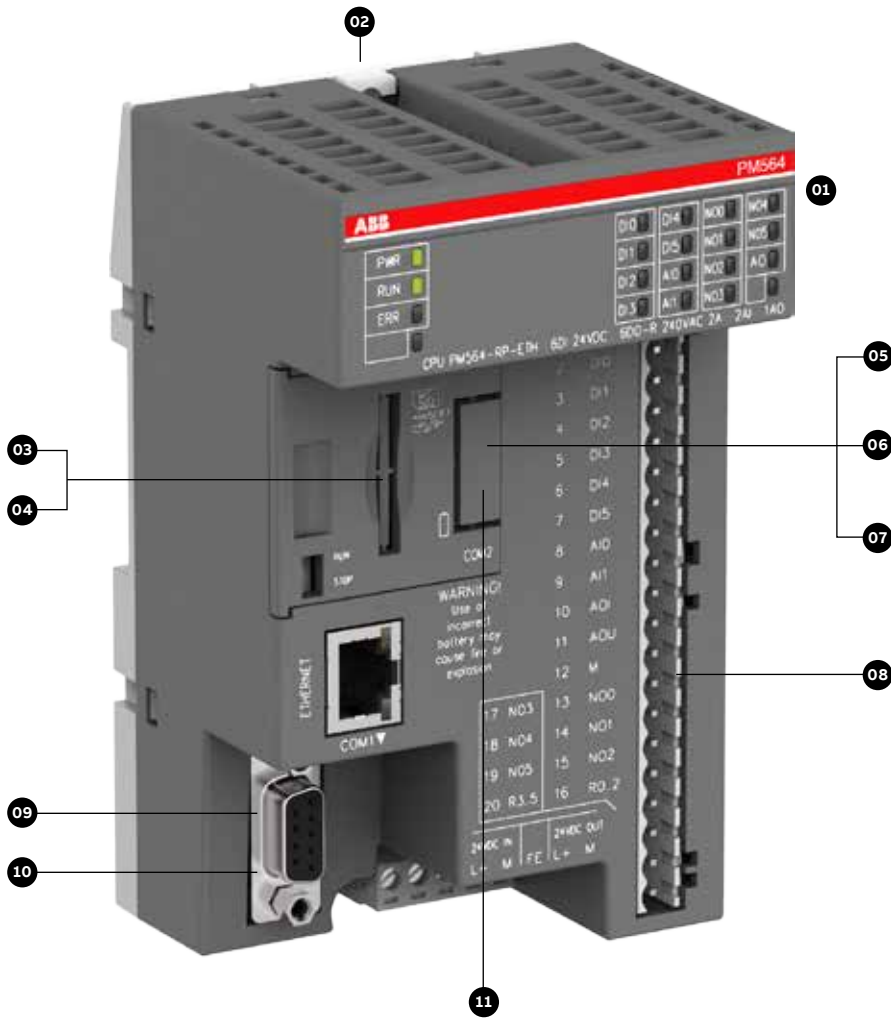

—
 01 AC500-eCo CPUs are locally expandable with up to 10 I/O modules (standard S500 and S500-eCo I/O modules can be mixed).

—
 02 Wall mounting

—
 03 SD-card adapter

—
 04 SD-card

—
 05 Adapter with realtime clock

—
 06 Adapter with COM2 & realtime clock

—
 07 Adapter with COM2

—
 08 Terminal blocks

—
 09 RS485 isolator for COM1

—
 10 COM1 USB

—
 11 COM2 USB programming cable

—
 12 AC500-eCo Starter kit. For more information, see page 211

—
 13 Input simulator

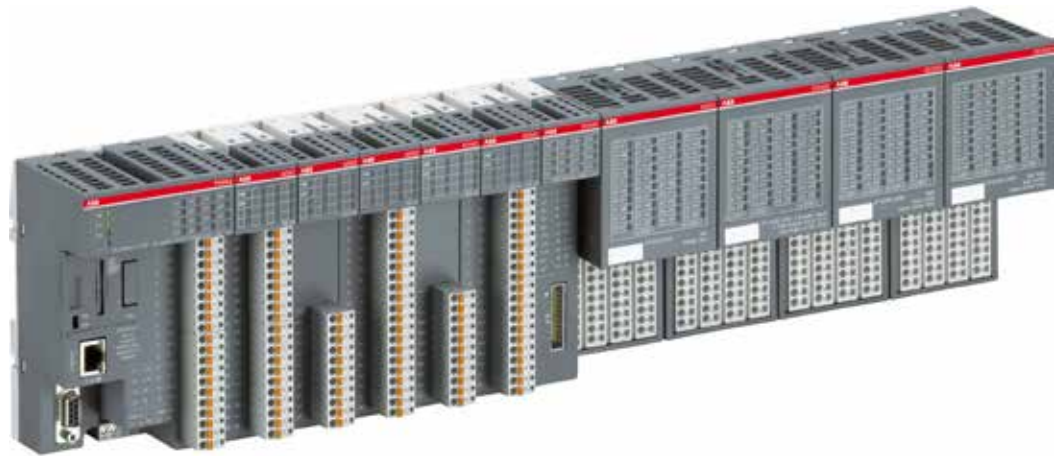

—
 01

01



—
 02



—
 03



—
 04



—
 05



—
 06



—
 07



—
 08



—
 09



—
 10

—
 11



—
 12



—
 13

PLC Automation product family

AC500 system characteristics

AC500 offers superior local expansion capabilities for I/O communication, best-in-class CPU functionality and industry-leading performance.

01

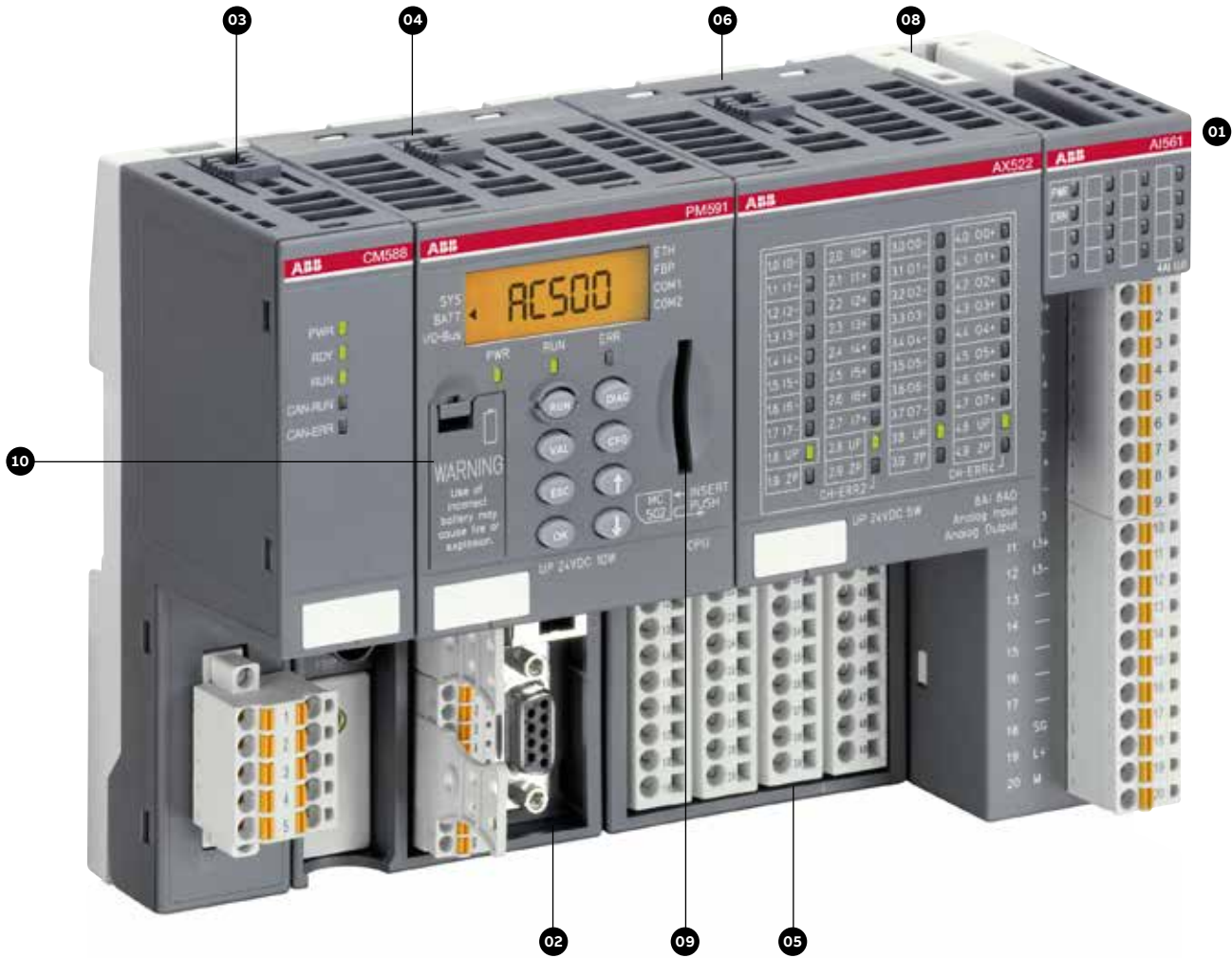

—
 01 AC500 CPUs are locally expandable with up to 10 I/O modules (standard S500 and S500-eCo I/O modules can be mixed).

—
 02 Terminal base / Terminal base V3

—
 03 Communication module
 Up to 4 modules for multiple combinations to communicate on nearly every protocol available

—
 04 CPU module / CPU V3 module

—
 05 S500 Terminal unit

—
 06 S500 I/O module

—
 07 Pluggable marker holder for S500 I/O modules with template

—
 08 S500-eCo I/O module

—
 09 SD-card

—
 10 Battery



01



02



03



04



05



06



07



08



09



10

01

PLC Automation product family

AC500 PM595 Controller system characteristics

01

The flagship of the AC500 platform, the AC500 PM595 Controller, was designed as scalable, flexible and efficient as the entire AC500 range.

With the AC500 CPU PM595, ABB launched a new core for machine control applications. Its high-performance processor with generous memory offers performance, security and reliability for the upcoming challenges of automation applications.

A variety of connectivity capabilities, integrated safety and utilizability even under rough environment provide machine builders with valuable benefits when performing their automation tasks.

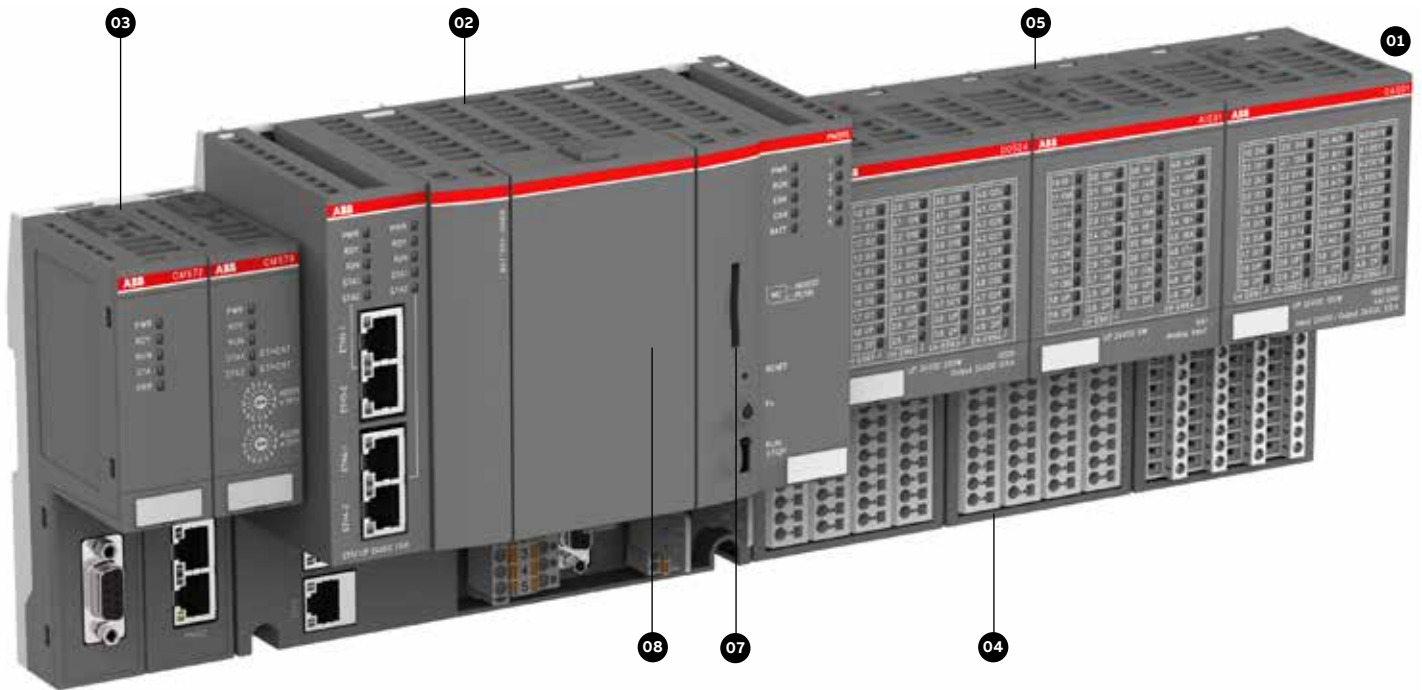

—
 01 AC500 CPUs are locally expandable with up to 10 I/O modules (standard S500 and S500-eCo I/O modules can be mixed).

—
 02 CPU with integrated connectivity and terminal base

—
 03 Communication module.
 Up to 2 modules for multiple combinations to communicate on nearly every protocol available and to include functional safety

—
 04 S500 Terminal unit

—
 05 S500 I/O module

—
 06 S500-eCo I/O module

—
 07 SD-card

—
 08 Battery

—
 09 Pluggable marker holder for S500 I/O modules with template

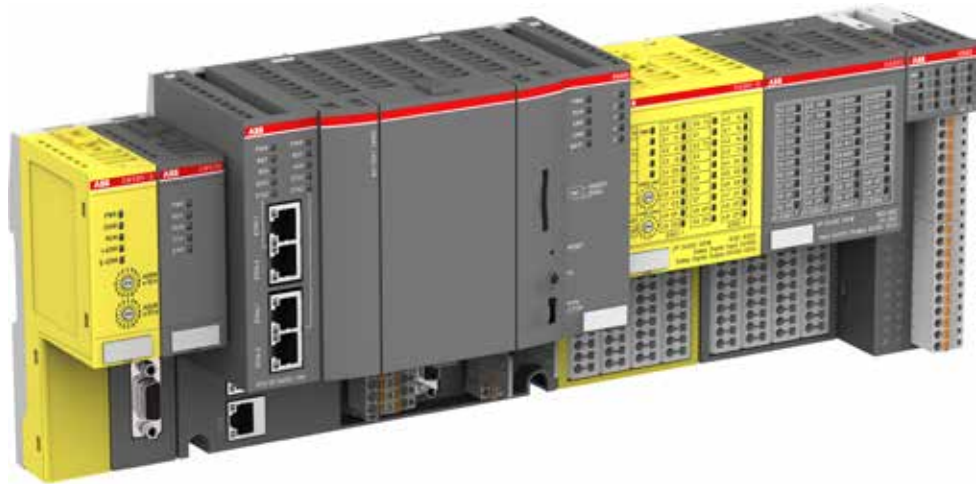

01



02



03



04



05



06



07



08



09

01

PLC Automation product family

Condition monitoring system CMS based on AC500

01

Predictable performance for your operations

Optimize your assets with a condition monitoring system (CMS) based on the proven AC500 platform. The new FM502 module can help you to improve your operations resulting in greater efficiency and higher reliability while minimizing service and operating costs.

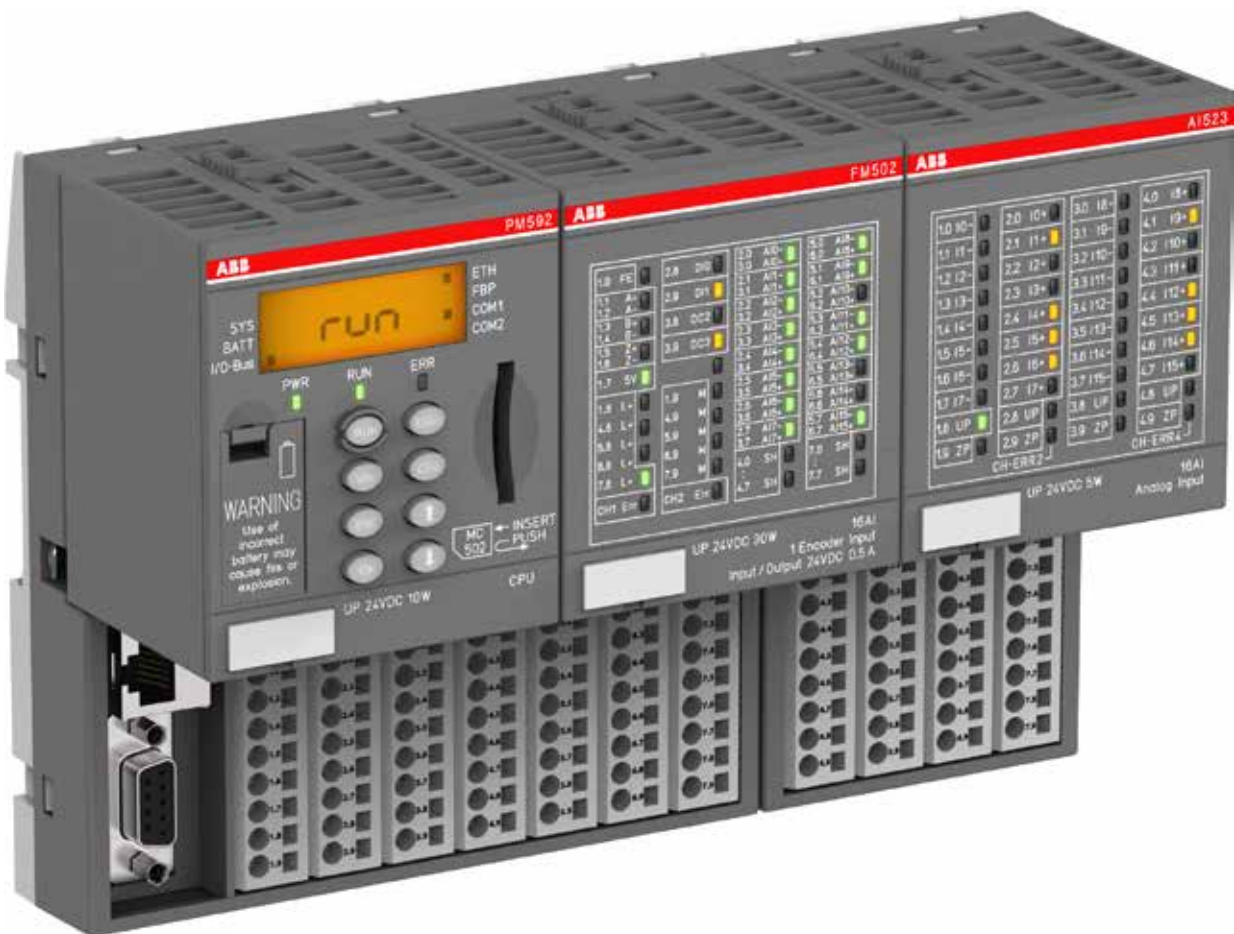

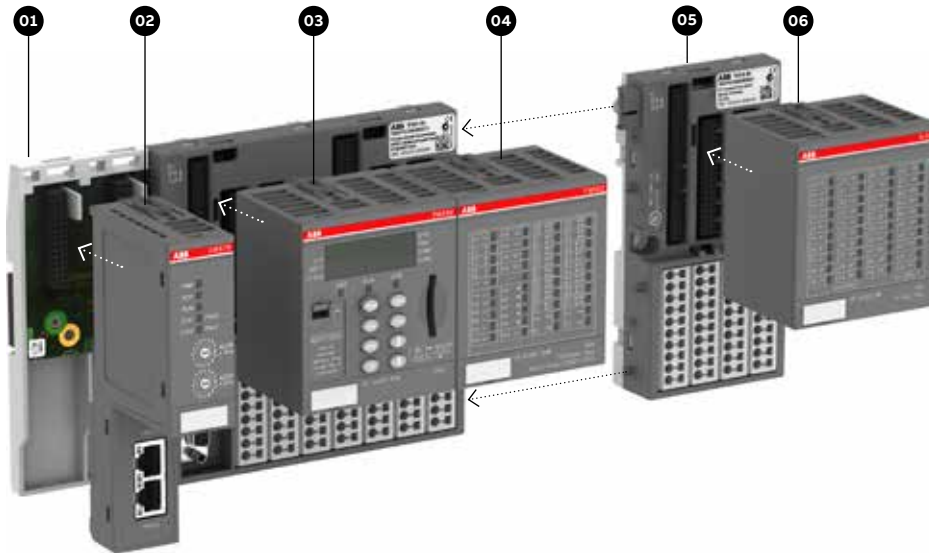

- 01 Terminal base: TF501 or TF521
- 02 Accomodating: 0 - 2 communication modules
- 03 PM592 CPU
- 04 FM502 CMS module
- 05 Expandable by I/O terminal units
- 06 Expandable by further I/O modules

Add predictable performance and productivity
 The new CMS module brings further reliability and easy integration with all kinds of machinery systems, enabling precise management of the real-time condition of your operation. This transparency takes your business and productivity to a new level with more efficient machines, predictable performance and significant reduction in maintenance costs.

No matter whether as stand-alone condition monitoring or integrated into machine or process control, the module is perfectly suited to build optimized, self-analyzing automation solutions that simultaneously perform condition monitoring, control, protection, safety and data logger functions with one controller. The fast data logger function also contributes to consistent high quality production, due to the possibility to combine control and production information directly.

CMS also protects against machine failures, unforeseen sudden damage, incorrect installation, and reduces maintenance and wear. Virtually no unscheduled downtimes boost plant availability and reliability.

Advantages

- Planned maintenance rather than spontaneous repair ensures predictable performance
- Approaching damage is identified very early
- Protection against spontaneous failures and operation in critical conditions
- Reduction of costs in maintenance and lost production time
- Plant availability is increased
- Optimum utilization of the aggregates until real end of life
- Simple to use, maintain, adapt or expand

AC500 + CMS = increased machine efficiency

All based on the AC500 platform modularity provides ultimate flexibility: Communication and I/O modules can be added and combined with Safety.

Expandable, robust and proven

- Stand-alone CMS or control integrated
- Expandable by AC500 communication modules and S500 I/O modules
- Proven and future proof, as based on AC500 platform
- Extreme conditions XC version available
- Fast data logger, e. g. for production quality
- Fast protection in parallel to condition monitoring

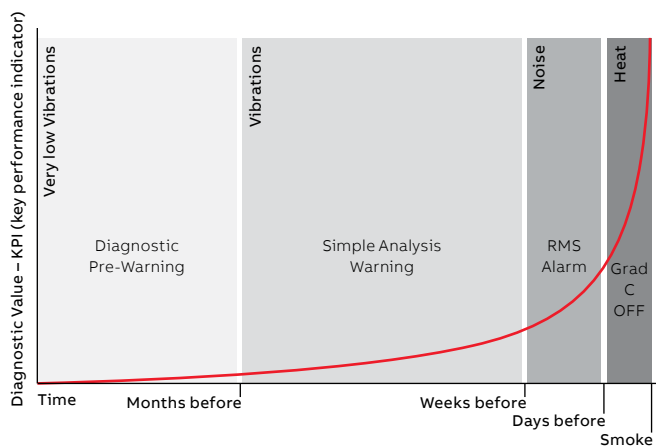

PLC Automation product family

AC500 V3

AC500 V3 delivers new features and higher performance

01

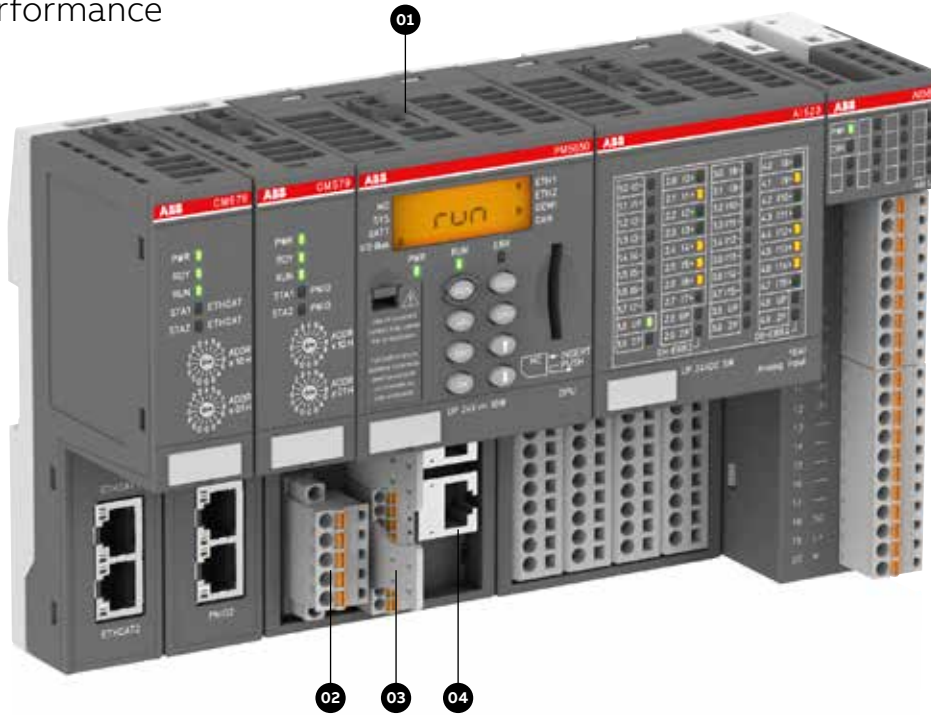

- 01 PM5650-2ETH CPU module
- 02 One CAN serial interface
- 03 One COM1 serial interface
- 04 Two Ethernet interfaces on RJ45

New CPU range PM56xx with higher hardware performance and state-of-the-art features, such as OPC UA, WebVisu, Object oriented programming, selectable fieldbus protocols, and much more.

Improved features and performance

The AC500 platform features a new more powerful CPU with larger memory for various automation solutions ranging from simple to complex motion control applications.

Configurable Ethernet fieldbus protocols, such as PROFINET IO (*), EtherCAT (*) or EthernetIP (*) running on standard Ethernet interfaces, enable the CPU to be used for applications with embedded protocols. The integrated Ethernet switch simplifies the network architecture, making additional external switches obsolete, and thereby also saving cabinet space. Fewer hardware types facilitate spare-parts stocking thus increasing flexibility.

The CPU also provides an integrated CAN / CANopen interface offering an easy-to-use and

fast connection to remote I/Os or drives. Various CAN protocols, e.g. CANopen Master and Slave (*), J1939 or CAN 2A/2B are available, and modular CAN is also supported.

Improved application flexibility and facilitated customer engineering

Less hardware products but more configurable and licensed features allow for customizing the product according to your specific application.

From 8 MB to up to 160 MB of memory and dynamic allocation to User Data, Program or Web Server, the new CPU meets almost every application requirement by adapting its configuration according to your needs.

State-of-the-art features tailored to your needs

Improved communication features integrated in the CPUs lower hardware costs and reduce the number of versions. Compatibility (*) with existing S500 / S500-eCo I/O modules, communication modules, communication interface modules and AC500-S safety modules of the existing AC500 PLC platform.

(*) in preparation

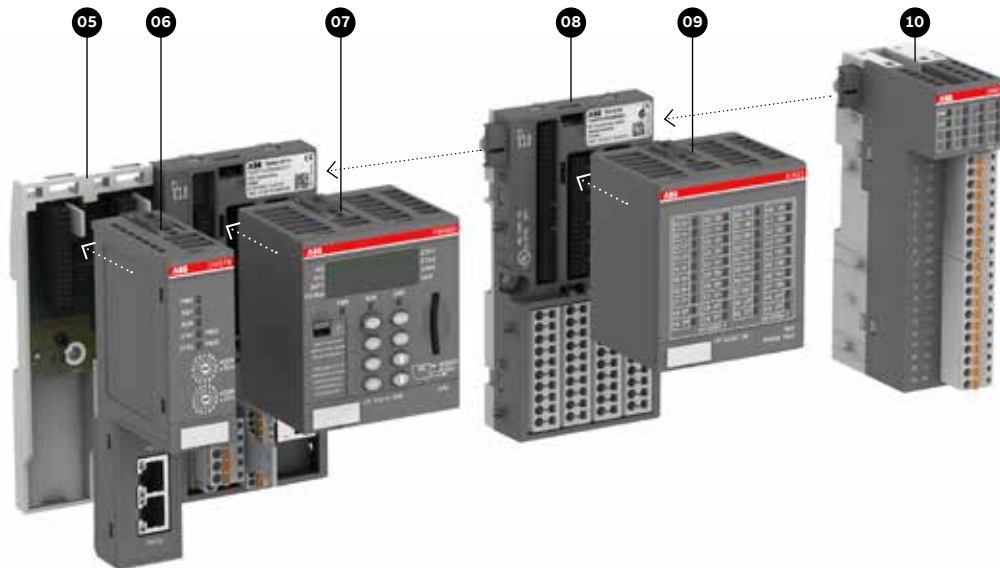

—
05 Terminal base:
TB5xxx-2ETH

—
06 Accomodating: 0,
1, 2 or more commu-
nication modules

—
07 PM56xx-2ETH
CPU module

—
08 Expandable by
I/O terminal units

—
09 Expandable by fur-
ther I/O modules from
the S500 product range

—
10 or S500-eCo
product range

Connection to third-party systems in open architecture

The integrated EthernetIP protocol (*) enables to connect existing applications or third-party systems. Standardized protocols or features such as OPC UA save time and costs and simplify the connection to SCADA.

New Web Server based on HTML 5

Two embedded Ethernet Interfaces:

- Independent (2xMAC) or Switched
- A lot of onboard ETH features:
 - OPC UA Server (easier connection to SCADA, panels, third-party, IoTSP)
- Ethernet IP adapter (*)
- Modbus TCP client/server
- IEC 60870 (with new features)
- Network variables (UDP)
- IEC 61850 protocol licensed

Reduced cabinet space with more integrated features

Integrated interfaces and configurable protocols reduce the CPU size thus saving cabinet space.

Reliability and security

Signed boot project, Firmware and secure download protect your application from unauthorized changes and HTTPs and FTPs strengthen your protection.

Functional safety

Reusing AC500-S safety solutions (*) provides state-of-the-art safety features and reduces engineering time.

Protection of customer investment

Reusing AC500/S500 products protects your investments and allows easy upgrades / migration from current applications to the latest technology for the coming years.

The PM56xx CPU can be used only with the new terminal base range TB56xx but can reuse many existing AC500 platform products like I/O modules, communication modules, etc.

Improved engineering, programming and debugging

Running on the new AC500 V3 CPU, several new features of the Automation Builder software make the AC500 platform more powerful and easier to use:

- Professional Version Control with subversion - application project management
- Object-oriented programming
- New optimized editors for IEC programming languages
- Virtual commissioning

For details, please refer to Automation Builder 2.0, section Highlights - productivity features page 50.

PLC Automation product family

Extreme conditions

PLC AC500-XC – the rugged variant of AC500 for extreme indoor and outdoor conditions.

01

The PLC AC500-XC is reliable, functionally safe and operational even under rough environmental conditions.





04



01



02



03



05



06

- 01 Terminal base
- 02 Extreme conditions communication module
- 03 Extreme conditions CPU
- 04 Extreme conditions CPU with integrated connectivity and terminal base
- 05 Extreme conditions S500 terminal unit
- 06 Extreme conditions S500 I/O module



Operation in extremely humid environments

- Increased resistance against 100 % humidity and condensation.



Extended operating temperature

- -40 °C up to +70 °C operating temperature.



Reliable in high altitudes

- Operation in altitudes up to 4000 m above sea level or air pressures up to 620 hPa.



Extended immunity to corrosive gases and salt mist

- G3, 3C2 / 3C3 immunity
- Salt mist EN 60068-2-52 / EN 60068-2-11.



Extended immunity to vibration

- 4 g rms random vibration up to 500 Hz
- 2 g sinusoidal vibration up to 500 Hz.



Extended EMC requirements

- EN 61000-4-5 surge immunity test
- EN 61000-4-4 transient / burst immunity test.

PLC Automation product family

Functional Safety

AC500-S Safety PLC is the solution for both simple and complex machine safety applications requiring maximum reliability, efficiency and flexibility.

01

This safety PLC protects people, machines and processes, the environment and investments - the ideal choice for wind turbine, crane, material handling, hoist, robot and other factory applications.





01



01



02



03

- 01 Safety CPU
- 02 S500 Safety I/O module
- 03 Safety terminal unit

Better integration and ease of programming
 Featuring a consistent look and feel across the entire range, the AC500 is the PLC of choice for applications where uncompromised flexibility, comprehensive integration and seamless communication are a must. Automation Builder seamlessly integrates your safety application in ABB PLC, Safety, Drives, Motion and HMI. Through integrated standard languages, such as IEC 61131-3, Automation Builder is easy to use thus allowing you to get started in virtually no time at all. And what is more: intuitive system configuration using one single tool ensures optimal transparency.

The AC500-S Safety PLC, ABB's latest addition to the AC500 family, facilitates the implementation of even most complex safety applications. Support of safety-relevant calculations, such as COS, SIN, TAN, ASIN, ACOS and LOG makes the AC500-S the ideal solution for crane engineering, wind power generation, robotics and hoisting applications. Safety programming with Structured Text (ST) and full support for Function Block Diagram (FBD) and Ladder Diagram (LD) programming and advanced features in PROFiSafe over PROFINET communication, like Shared Device functions, gives you greater flexibility and simplifies safety application development. The AC500-S Safety PLC is also available in a version for extreme conditions.

PLC Automation product family

CP600-eCo, CP600 and CP600-Pro control panels

01

With comprehensive but easy-to-use functionalities, ABB control panels stand out from competitor products. At one single touch, they intuitively provide operators with tailor-made operational information for production plants and machines. CP600-eCo, CP600 and CP600-Pro control panels make machine operation efficient, predictable and user-friendly.





CP600-eCo control panels

Economic HMI portfolio for basic applications

Control panels in three different screen sizes from 4.3" to 10.1" in ABB design or just black provide HMI functions typically required for basic applications. The engineering tool PB610 Panel Builder 600, part of Automation Builder, ensures easy scalability on the CP600 platform.

Designed for basic applications

- The widescreens available in 4.3", 7" and 10.1" are suitable for many applications.
- Protocols for ABB PLCs, machinery and motion drives for Ethernet and serial connection make these control panels first choice for ABB automation solutions.
- OPC UA client and server functions make them well prepared for future communication solutions.
- Engineering by means of PB610 Panel Builder 600, part of ABB's Automation Builder, facilitates integration into automation packages and enables good scalability on the CP600 platform for different applications.

Slim industrial design

The slim plastic housing in attractive industrial design with a mounting depth of 29 mm enables installation even in narrow spaces. All connectors are located on one side. Landscape and portrait mounting options provide installation flexibility and various HMI presentations. These devices are available either in ABB design or in black.

State-of-the-art connectivity

- Ethernet interface 10/100 Mbit for easy connectivity to ABB automation components.
- Flexible serial connectivity to automation components without Ethernet interface.
- USB host for flexible data storage and easy updating.

CP600 control panels

Comprehensive HMI portfolio for versatile applications

Various control panels in screen sizes from 4.3" to 15" provide comprehensive HMI functions for a wide range of applications. The range is completed by panels in sanitary design as well as black variants. The engineering tool PB610 Panel Builder 600, part of Automation Builder, ensures easy scalability on the CP600 platform.

Various designs for diverse applications

- Seven different screen sizes with standard aspect ratio or widescreen from 4.3" to 15" are suitable for the most diverse applications.
- Protocols for ABB PLCs, machinery and motion drives for Ethernet and serial connection make these control panels first choice for ABB automation solutions. The IRC5 protocol enables easy direct communication with ABB robotics controllers.
- OPC UA client and server functions make them well prepared for future communication solutions.
- Engineering by means of PB610 Panel Builder 600, part of ABB's Automation Builder, facilitates integration into automation packages and enables good scalability on the CP600 platform for versatile applications.

Solid aluminum design

The robust aluminum housing in attractive industrial design, providing all connectors on one side, enables installation in various environments. Landscape and portrait mounting options provide installation flexibility and various HMI presentations.

Various options for flexible connectivity and data storage

- 2 Ethernet interfaces 10/100 Mbit with integrated switch for easy connectivity to ABB automation components.
- Flexible serial connectivity to automation components without Ethernet interface.
- USB hosts for the flexible connection of printers, accessories or data storage and easy updating.
- SD card slot for easy data storage and updating.

PLC Automation product family

CP600-eCo, CP600 and CP600-Pro control panels

01



CP635-FB, CP635-FW

Control panels in sanitary design for demanding applications

Hygienic standards and cleaning procedures in food & beverage applications typically require a special design of the relevant automation components. Human machine interfaces (HMIs) for meat processing have to comply with really challenging requirements. As a consequence e.g. mixers and cutters for meat processing are usually still equipped with conventional lamps and switches instead of state-of-the-art HMIs.

The CP635-FB and CP635-FW control panels are especially designed for reliable operation in harsh environments such as mixers in meat processing. These panels withstand the demanding cleaning procedures in meat processing better than most of the similar products in the market: stainless steel frame, rounded edges and front protection class IP69K make them withstand harsh cleaning procedures with high-pressure hot water jets directed at the equipment in different angles according to the relevant hygienic standards.

The displays of the new control panels CP635-FB and CP635-FW are brighter than standard units, because of real glass screens. This ensures clear information for operators/users even in bright environments. Capacitive touch screens enable quick and easy operation even with gloves.



CP600-Pro control panels

Outstanding HMI portfolio designed for challenging applications

New control panels in screen sizes from 5" to 21.5" provide comprehensive HMI functions with multi-touch operation for a wide range of applications. Real glass fronts and an increased operating temperature range of -20...+60 °C make them first choice even for harsh environments. The engineering tool PB610 Panel Builder 600, part of Automation Builder, ensures easy scalability on the CP600 platform.

New multi-touch control panels for high-end applications

- The portfolio includes five screen sizes from 5" to 21.5", all widescreen, with multi-touch real glass screens for demanding high-end applications.
- The wide range of operating temperatures of -20...+60 °C makes them suitable for a wide range of applications and first choice for demanding ones.
- Protocols for ABB PLCs, machinery and motion drives for Ethernet and serial connection make these control panels first choice for ABB automation solutions.
- OPC UA client and server functions make them well prepared for future communication solutions.
- Engineering by means of PB610 Panel Builder 600, part of ABB's Automation Builder, facilitates integration into automation packages and enables good scalability on the CP600 platform for versatile applications.

Real glass front and solid aluminum enclosure

CP600-Pro control panels have real glass fronts and robust aluminum enclosures in attractive industrial design, with all connectors located on one side, for installation in various even demanding environments. Landscape and portrait mounting options support installation flexibility for various HMI presentations.

Future-orientated flexible connectivity and data storage

- Up to 3 Ethernet networks with different physical layers for easy connectivity to ABB automation components for future-orientated networking concepts.
- Flexible serial connectivity to automation components without Ethernet interface.
- USB hosts for connecting printers and accessories, data storage and updating.
- SD card slot for easy data storage and updating.

Mobile / remote access to HMI

All control panels of the CP600 platform provide flexible access to HMI applications via mobile devices: PB610 Panel Builder 600 enables easy creation of HTML5 pages for mobile devices like smartphones, tablets etc. within standard HMI applications. Remote devices can log in to the HMI application without installation of an app.

**PB610 Panel Builder 600****Engineering platform for easy design of tailor-made graphical interfaces for the CP600 platform**

Tailor-made human machine interface (HMI)

- For the efficient design of versatile automation solutions: vector graphics (*.SVG) for precise, easily scalable, dynamic HMI design.
- Alpha blending for realistic transparency effects.
- Libraries including rich sets of widgets – ready-to-use graphical objects for designing tailor made, flexible HMI applications.
- Easy creation of customized widgets through the combination/modification of standard widgets.
- Customized widgets clearly arranged in user galleries.
- Page templates for the efficient design of professional HMI applications.
- Tailor-made for customized solutions: numerous configuration options for all HMI elements.
- Realization of customized functions and individual dynamic manipulation via Java Script with debugger.
- Easy data acquisition and trend presentation.
- Reliable user and group access control.
- Rich set of configurable features for the design of tailor-made HMI applications: dynamic objects, data acquisition, alarm handling, multi-language applications, recipes, ...
- HMI simulation for efficient commissioning.

PLC Automation product family

PLC Automation website – online tools

The www.abb.com/plc website is a mine of information on our products and documentation.

01

ABB HOME + OFFERINGS + PLC AUTOMATION GLOBAL SITE

LOG IN [Partners](#) | [ABB](#)

You can view this page in: [EN](#) [DE](#) [IT](#) [ES](#) [PL](#) [SV](#) [FI](#) [ZH](#) [JA](#)

PLC Automation

ABB's automation devices deliver solutions with high performance and flexibility to be effectively deployed within diverse industries and applications including water, building infrastructure, data centers, renewable energy, machinery automation, material handling, marine and more.

[Are you looking for support or purchase information?](#)
[Contact us](#)

01 Our offering

- 01 Programmable Logic Controllers PLCs
- 02 Automation Builder
- 03 ABB zenon
- 04 Control panels
- 05 Legacy products

06 Highlights

- Distribution center using AC500 with new safety CPUs
- Embedding safety I/Os in ABB robots enhances man-machine collaboration
- Advanced control and safety technology improves tower crane performance
- Using standard HMIs to reconfigure safety control functions of PLC automation systems
- Predictive Performance with AC500 Condition Monitoring CMS
- More PLC stories, articles and videos
- New control panels CP635-Fx for reliable operation in harsh environmental conditions
- Leadership in industrial automation - ABB completes acquisition of B&R

07 Popular links

- Main catalog
- Industry solutions
- Downloads
- Training & support
- Partner network
- Spare parts

08 Related products

- Drives
- Motion control
- Robotics
- Distributed control systems
- Safety solutions

09 Contact information

What would you like to do?



Submit your inquiry

Please select country from the list below

Country

Name

Company

E-Mail

Phone

Your message

[→ Privacy policy](#) Cancel Send message

Your local ABB Sales Team

Please select country from the list

[▲ Close](#)

01 – Programmable Logic Controllers PLCs

- AC500-eCo (CPUs, S500-eCo I/O modules, Accessories)
- AC500 (CPUs, Communication modules, Communication interface modules, S500 I/O modules, Accessories, Condition Monitoring CMS)
- AC500-XC (CPUs, Communication modules, Communication interface modules, S500 I/O modules, Accessories, Condition Monitoring CMS)
- AC500-S (CPUs, S500 I/O modules)

02 – Automation Builder engineering suite

- Download link
www.abb.com/automationbuilder

03 – ABB zenon

04 – Control panels

- CP600-eCo (Devices, Software, Accessories)
- CP600 (Devices, Software, Accessories)
- CP600-Pro (Devices, Software, Accessories)

05 – Legacy products

- AC31 and previous series
- CP400
- CP500
- DigiVis 500
- Wireless products

06 – Highlights

- Articles, videos, product news, success stories and more

07 – Popular links

- Main catalog
- Industry solutions
- Documents and Downloads
- Training & support
- Partner network
- Spare parts

08 – Related products

- Drives
- Motion control
- Robotics
- Distributed control systems
- Safety solutions

09 – Contact information for your country

Automation Builder

Integrated engineering suite

043	Key features
044–045	Ordering data
046–047	Software features
048–049	Libraries features
050	Highlights – productivity features
051–052	Virtual Commissioning Platform – virtual system testing

Download Automation Builder from www.abb.com/automationbuilder

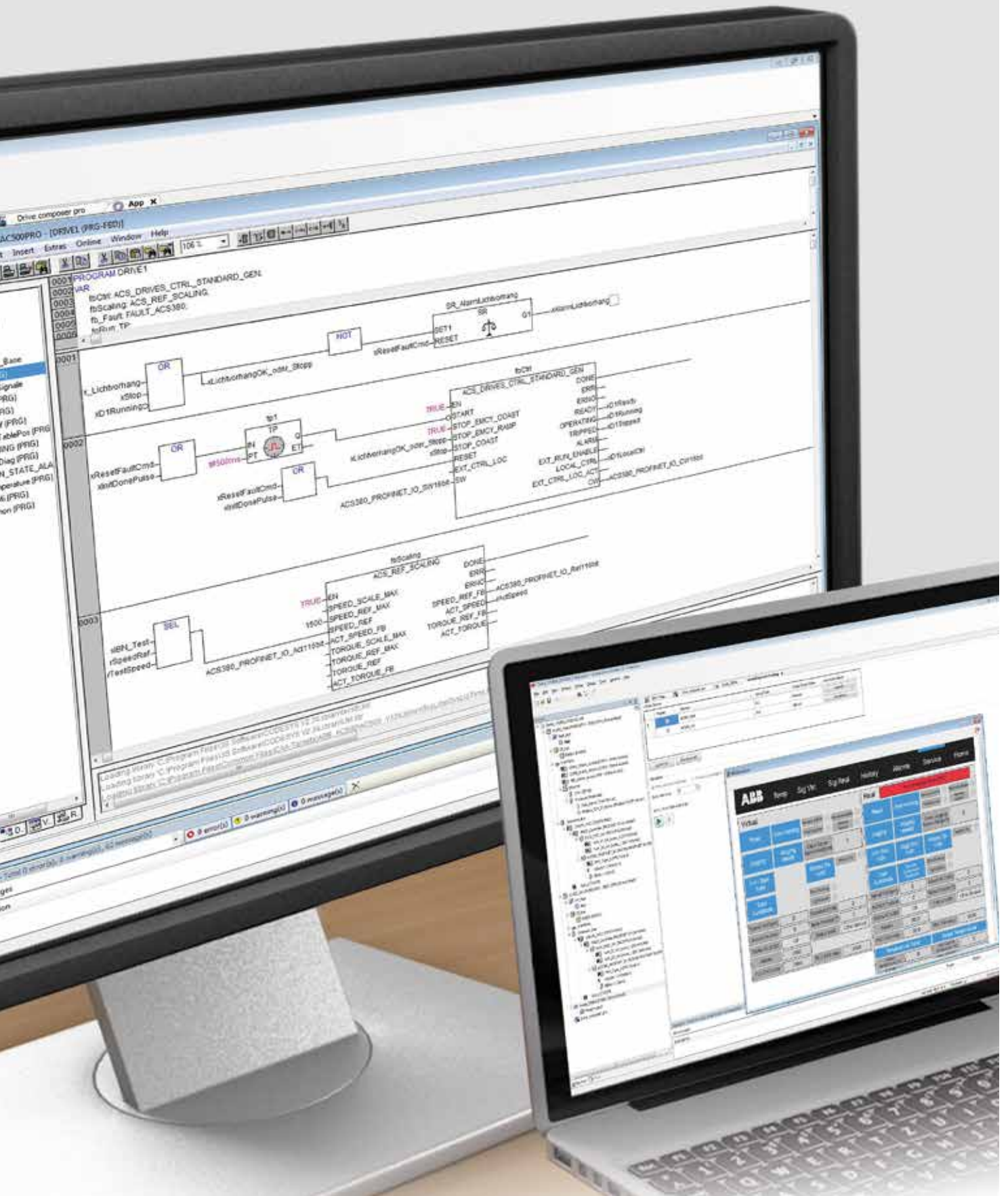

Automation Builder

Key features

Stay in control of your project: Automation Builder integrates engineering tools for PLCs, safety, drives, motion, control panels and SCADA

02



Reduce risk: Manage complexity and realize connectivity easily

Increase efficiency: Build comprehensive solutions with integrated engineering that add value to your business

Save time: Test systems effortlessly in virtual time without real hardware using Virtual Commissioning technology

Automation Builder

Ordering data

Automation Builder

- Automation Builder connects the engineering tools for PLC, safety, drives, motion, control panels and SCADA. The software suite integrates products into solutions that create value for your customers, giving you greater control of your projects, reducing risk and saving time.
- Open systems win. They lead to more innovation, value and freedom of choice for your business. Automation Builder enables you to adapt the tool chain to your needs and workflows. The software is open for your specific product and communication technology to build your distinct solution.
- Automation Builder 2.1 provides advanced features, further increasing engineering productivity for discrete automation solutions.
- For details please refer to Automation Builder – Software Features.

Automation Builder Editions

For	Description	Type	Order code	Price	Weight (1 pce) kg
Free 61131-3 engineering for simple PLC solutions	Automation Builder 2.x Basic (1)	-	-	FREE	-
Integrated Engineering for PLC, drives, motion, SCADA, panels	Automation Builder 2.x Standard (2)	DM200-TOOL	1SAS010000R0102		0.005
	Automation Builder 2.x Standard Upgrade (2)(3)	DM201-TOOL-UPGR	1SAS010001R0102		0.005
Integrated Engineering for PLC, drives, motion, SCADA, panels and features for engineering productivity and collaboration	Automation Builder 2.x Premium (5)	DM202-PREM	1SAS010002R0102		0.005
	Automation Builder 2.x Premium Upgrade (4)(5)	DM203-PREM-UPGR	1SAS010003R0102		0.005

Automation Builder add-ons

Functional safety engineering	AC500-S Safety PLC programming	DM220-FSE (2) DM221-FSE-NW (5)	1SAS010020R0102 1SAS010021R0102		0.005
Virtual system testing based on Virtual commissioning technology	Virtual Commissioning Platform for Automation Builder 2.x (6)(8)(9)	DM250-VCP (2)	1SAS010050R0102		0.005
		DM251-VCP-NW (5)	1SAS010051R0102		
Collaborative engineering support	Professional Version Control with Subversion for Automation Builder 2.x (6)(9)	DM207-PVC (2)	1SAS010007R0102		0.005
		DM214-PVC-NW (5)	1SAS010014R0102		

Accessories

Automation Builder licensing based on a USB Key	USB Key for Automation Builder without license (7)	DM-KEY	1SAP193600R0001		0.010
---	--	--------	-----------------	--	-------



Automation Builder

Automation Builder

Ordering data

Libraries

For	Description	Type	Order code	Price	Weight (1 pce) kg
all AC500 V2 CPUs	Solar library (10) (5)	PS562-SOLAR	1SAP195000R0101		0.010
all AC500 V2 CPUs	Water library (10) (5)	PS563-WATER	1SAS030000R0101		0.010
all AC500 V2 CPUs	Motion Control library, Extended (10) (5)	PS552-MC-E	1SAP192100R0102		0.010
all AC500 V2 CPUs	Temperature control library (10) (5)	PS564-TEMPCTRL	1SAS030010R0101		0,010
all AC500 V2 CPUs	BACnet library B-ASC profile (10) (5)	PS565-BACnet-ASC	1SAP195500R0101		0,010

(1) Free license

(2) Single user license - bound to PC or DM-KEY (USB Key)

(3) Purchase this option to upgrade Automation Builder 1.x Standard to Automation Builder 2.x Standard

(4) Purchase this option to upgrade Automation Builder 1.x Premium to Automation Builder 2.x Premium

(5) Network license for shared usage within a local area network. Per license one user can use the license at the same time.

(6) Add-on to Automation Builder 2.x Premium edition. Automation Builder 2.x Premium must be purchased separately

(7) Does not contain license. Automation Builder license must be purchased separately. Can carry an arbitrary number of licenses.

(8) Enables virtual Drives (ACS380, ACS580, ACS880) and virtual PLCs (AC500 V2, AC500 V3).

(9) Expert function - only available on request

(10) Delivery includes single user license - bound to PC or DM-KEY (USB Key), software can be downloaded.

Runtime Licenses

For	Description	Type	Order code	Price	Weight (1 pce) kg
All AC500 CPUs (1)	Modbus TCP HA runtime license	PS5601-HA-MTCP	1SAP195400R0101		0.010
All AC500 V3 CPUs	IEC 61850 protocol runtime license	PS5602-61850	1SAP195600R0101		0.010
All AC500 V3 CPUs	Remote target Visu runtime license for use with CP600	PS5603-RTVISU	1SAP195700R0101		0.010

(1) available after Q1 2018

Further application libraries and examples:

Please check and download further libraries and examples from: www.abb.com/plc

Use English language setting, then click on "Application Examples".

Application Examples explain functionality by using e.g. standard Automation Builder libraries and functions in simple examples. They are tested in the described example configuration and functionality only, they come with documentation and are free of charge.

Applications Examples help to minimize valuable programming and testing time for specific applications.



AC500 libraries

Automation Builder

Software features

Automation Builder 2.0		Basic	Standard	Premium
Features and target hardware		Basic system engineering FREE	Integrated system engineering	Productivity and collaboration
Productive engineering	Integrated engineering for PLCs, safety, robots, motion, drives, SCADA and control panels	○	●	●
	Integrated tool suite installation and maintenance (online and offline)	●	●	●
	Project handling including project archive and backup features	●	●	●
	Project lifecycle support (version profiles and project migration)	●	●	●
	Native language support in EN, DE, ES, FR, CN	●	●	●
	Support of standardization and re-use by flexible configurations of machine variants and advanced IO device handling	●	●	●
	Support of re-use by cross project and cross Automation Builder instance copy&paste	●	●	●
	ECAD roundtrip engineering - AC500 and EPLAN / Zuken E3			●
	ECAD roundtrip engineering for 3rd party devices - PLC and EPLAN / Zuken E3			●
	Bulk data import/export with change control to any tool via CSV (also via copy&paste)			●
	Bulk data import/export of device and I/O lists and IEC 60870-5-104			●
	Change management support by project compare			●
	Device type editor for Open Device Integration			●
	Virtual system testing based on Virtual Commissioning Technology			○
Collaborative engineering support by Professional Version Control with Subversion			○	
PLC engineering (AC500 V2)	For: AC500-eCo, AC500 V2, AC500-XC, AC500-S Safety, AC500 local I/O modules, AC500 extension modules			
	PLC application programming (IL, LD, FBD, SFC, ST) plus CFC	●	●	●
	PLC firmware update, download and online change to single or several PLCs	●	●	●
	PLC simulation and debugging	●	●	●
	Integrated firmware identification and update (PM and CM devices)	●	●	●
	Configuration of communication protocols for TCP/IP, Modbus, CS31, IEC60870-5-104	●	●	●
	Open device integration for Modbus devices		●	●
	Configuration of communication protocols for PROFINET, PROFIBUS, EtherCAT, CAN		●	●
	C/ C++ application programming (GNU compiler)			●
Virtual system testing including PLCs based on Virtual Commissioning Technology			○	
PLC engineering (AC500 V3)	For: AC500 V3 and supported AC500 local I/O modules and AC500 extension modules			
	PLC application programming (LD, FBD, SFC, ST) plus CFC	●	●	●
	PLC firmware update, download and online change to single PLC	●	●	●
	PLC simulation and debugging	●	●	●
	Integrated firmware identification and update (PM and CM devices)	●	●	●
	Configuration of communication protocols for TCP/IP, Modbus TCP, Modbus RTU, IEC60870-5-104, CAN	●	●	●
	Configuration of communication protocols for PROFINET, EtherCAT, CM Devices		●	●
	Remote target Visu runtime license for use with CP600 (1)	○	○	○
	Virtual system testing including PLCs based on Virtual Commissioning Technology			○
Safety PLC engineering (integrated solutions)	For: AC500-S Safety CPU, Safety I/Os and PROFIsafe devices			
	Safety PLC application programming (LD, FBD, ST)		○	○
	Fieldbus protocol engineering for PROFIsafe		○	○
Safety PLC engineering (stand-alone solutions)	For: Pluto Safety PLC			
	Safety Engineering with Pluto Manager	○	○	○
SCADA engineering	For: ABB zenon			
	Integrated SCADA and PLC engineering with ABB zenon Editor		○	○

Automation Builder

Software features

Automation Builder 2.0		Basic	Standard	Premium
Features and target hardware		Basic system engineering FREE	Integrated system engineering	Productivity and collaboration
Control Panel engineering	For: CP600, CP600-Pro, CP600-eCo, CP600-WEB, PB610-R			
	CP600 and CP600-Pro panel configuration with PB610 Panel Builder 600	○	●	●
	CP600-eCo panel configuration with PB610 Panel Builder 600	●	●	●
	PLC tag data import	●	●	●
	Control Panel simulation for Virtual Commissioning Technology	●	●	●
Drive engineering	For: ACS355, ACS380, ACS550, ACS580, ACS850, ACQ810, ACS880, DCT880 (runtime license needed), ACSM1			
	Drive application programming (IL, LD, FBD, SFC, ST) plus CFC	●	●	●
	Drive management, configuration and diagnosis with common process data editor (Drive - PLC)		●	●
	Drive engineering in Drive composer pro	○	●	●
	Virtual system testing including Drives based on Virtual Commissioning Technology (only for ACS380, ACS580)			●
Motion engineering	For: MicroFlex e150, Motiflex e180, Motiflex e190			
	Motion application engineering with Mint WorkBench	●	●	●
	PLC tag data import	●	●	●
Modbus TCP engineering	For: CI521-MODTCP, CI522-MODTCP			
	Configuration of unbundled Modbus TCP CI (communication interface) devices	●	●	●
Solution engineering	Drive library (PS553-DRIVES)	●	●	●
	Motion Control for AC500 V2 PLCopen Motion library (PS552-MC-E)	○	○	○
	Solar library (PS562-SOLAR)	○	○	○
	Water library (PS563-WATER)	○	○	○
	Temperature Control library (PS564)	○	○	○
	BACnet – ASC library (PS565)	○	○	○
	AC500 High Availability HA-CS31 library	●	●	●
	AC500 High Availability HA-Modbus TCP library V2/V3 (1)	○	○	○
	PackML Library (*)		●	●
	FTP client Library (PS554) (*)		●	●
	Signal Processing Package (*)		●	●
	Pumping Library (PS571) (*)		●	●
	HVAC Library (*)		●	●
IEC61850 for AC500 V3 (1)	○	○	○	
Further features	PLC Multidownload tool for large installations		●	●
	OPC server and clients, service tool, PLC gateway, IP configuration and visualization		●	●
Operating systems	Recommended: Windows 7 32/64-bit, Windows 8.1 32/64-bit, Windows 10 32/64-bit (2)	●	●	●
PC requirements	Minimum: 1 GHz, 3 GB RAM, 14 GB free disk space	●	●	●

● included

○ optional (additional license required) as integrated tool / feature / library

○ optional (additional license required) as standalone tool / feature - not integrated in Automation Builder

(1) additional runtime license per PLC required

(2) Limited support for Windows server operating systems - please contact ABB for further information

(*) Technology Preview: Technology Previews are non-final versions of our product and should not be taken as a measure of the fit, finish, capability, and overall quality of the product. While we don't stop using these versions in projects, we don't recommend it if data loss and the usual quirks of preview software cannot be afforded.

Automation Builder

Libraries features



PS562-SOLAR

Solar tracker solution library

Library for solar tracking applications enabling fast engineering, especially together with ABB's drives and motors

Covers different tracker configurations and different algorithms for accuracy needs

- Control of trackers in parabolic trough, power tower, PV and CPV applications.

Complete library package for different tracking use cases, plug and play:
Example program with detailed explanations and visualizations

- Control of the tracker adaptable to different needs and conditions, to achieve maximum efficiency of installation
- Exact positioning of different axes with the following accuracies:
 - NOAA algorithm 0.03 Grad
 - NREL algorithm 0.0003 Grad.
- Input / sensor adaptation
- Communication
- Different actuators / drives control
- All needed modes for simple commissioning and manual operation:
 - Fast and simple calibration of the trackers, offering manual repositioning and fine tuning
 - Safety positions
 - Back tracking.

PS563-WATER

Water solution library

Library supporting the most common functions in many water applications

- Flexible data logging options:
- Especially suited for remote communication like GSM/GPRS
 - Timestamp in logging
 - Integrated variants for simple use with IEC 60870-5-104
 - Logging to files: storage capacity only dependent on memory availability
 - Flexible log conditions (cyclic, event or tolerance based).

Support for pumping station functions with different operation modes

- Standard multidrive functions (PLC based)
- Advanced functionality together with ABB ACS and ACQ810 drives
- Detailed diagnosis
- Energy efficiency functions
- Multidrive functions
- Flow estimation.

Control Panel CP600 support for ACQ810:
Fast and simple configuration for pumping stations with reduced programming effort via pre-built visualization screen templates.

Application examples for fast engineering and startup.

PS564-TEMPCTRL

Temperature control library

Library packet for advanced temperature control applications

- Includes extended, flexible PID functionality with Auto-tune for temperature control
- Enhanced response time and reduced overshoots and oscillations
 - Option to optimize control for very different heating and cooling characteristics.
 - Enhanced tolerance to thermocouple input noise
 - Normal and standby- setpoints
 - Multi-level temperature monitoring and alarms provides flexible operation and protection for machine and process
 - Logging enables complete overview of the actual situation and past behavior
 - Configurable output timing, synchronization for peak load shaving in multi-zone setups
 - Simulation blocks enable off-line setup and pre-test of a new project
 - Group-programming

Example projects, including adaptable HMI project for CP600 family, well suited for multi zone and grouped temperature control e.g. in Extrusion:

- Easy to use operator interface
- Provides quick access to setup, monitoring and tuning screens for multiple zones
- Easily expandable to a large number of zones
- Zones: heat-, cool-only or heat-and-cool

License Package (Software is part of Automation Builder)

NOAA: PM554-XX and above
NREL: PM573-ETH and above.

All AC500 CPUs.
Logging: PM573 and above.

All AC500 CPUs.

Automation Builder

Libraries features



PS565-BACnet-ASC

BACnet communication library

This library enables AC500 PLCs to connect OEM or infrastructure applications to BMS (Building Management Systems) or other controllers.

The PS565-BACnet-ASC library enables AC500 to serve as BACnet server device, complying with the B-ASC Device Profile and interfacing control requirements, and acting as hardwired or Modbus-to-BACnet gateway.

It supports BACnet IP (Ethernet) and BACnet MS/TP (serial) networks. The scalable AC500 platform is compatible with the BACnet library starting from eCo PM5x6 with larger memory (~ 300 objects) up to PM595 (more than 5000 objects).

The very transparent, object-oriented publish and subscribe approach of BACnet allows efficient and well-documented engineering and collaboration of many different parties in large infrastructure projects.

Highlights

- Easy-to-use BACnet communication directly in the CPU
- No coupler or gateways required
- Cost-efficient particularly for OEMs and projects
- Interfacing other non-BACnet devices to BMS.

PS565 for AC500 is BTL-approved and certified

PS552-MC-E

Motion control library

Library enabling fast and standardized engineering according to PLCopen standard when using ABB's AC500 PLC for motion control, especially together with ABB's motion control Drives.

Covers different motion control options for single and multi-axis motion control applications:

- Drive-Based and PLC-Based motion
- In PLC based motion, the position control loop could be closed in the PLC or drive (with synchronized network)
- Single axis, multi-axis and coordinated motion
- Defined Jerk limitation by polynomial interpolation
- Spline interpolation or polynomial interpolation for cam curves, position velocity or acceleration profiles available
- Possible to switch over between different movements and cam curves directly
- Latch functionality by utilizing fast drive inputs for ACS350, ACS800, ACSM1
- Drive based motion: commands from PLC, drives perform interpolation and control loop
- Supports the new Pulse Train Output module FM562.

PLCopen functions:

- Administrative Function Blocks
- Single axis Function Blocks
- Multiple axis Function Blocks
- Homing Function Blocks
- Coordinated Motion Function Blocks
- Additional ABB specific Function Blocks for further simplification.

PS5601-HA-MTCP

High Availability library using Ethernet

Same philosophy as proven serial/CS31 based library

Enables hot-standby redundancy with bumpless transfer with standard AC500 CPUs.

Supports 3 redundancy levels:

- CPU
- I/O
- SCADA communication

Library packet with Libraries basing on Modbus TCP for field communication and using CI52x communication interface modules as I/O clusters with redundant connection.

Ethernet redundancy bases on external managed switches: Ethernet Network can be independent of used redundancy mechanism.

- Daisy chain in ring possibility of CI52x with MRP, DLR as redundancy protocol
- Fast reaction and switchover nearly independent of Nr. of clusters
- Integration possibility for other devices e.g. ABB drives in the redundancy scheme

Scalable redundancy, where CPU's can be placed also far from each (...kilometers if networks with optical fibres are used).

Includes AC500 Bulk Data Manager as a tool for efficient configuration and cluster engineering

- Configuration and export of project, cluster, module/parameters, signal names, visualization ("Code generation")

Application examples for fast engineering and startup.

Run time License per CPU to be bought

License Package (Software is part of Automation Builder)

All AC500 CPUs, starting from PM5x6 (~300 objects) up to PM595 (>5000 objects)

All AC500 CPUs (options and no. of blocks/ functions and performance will depend on CPU size and memory).

All AC500 CPUs V2 and V3

Automation Builder

Highlights – productivity features

Improved engineering, programming and debugging

Running on the new AC500 V3 CPU, several new features from Automation Builder software make the AC500 platform more powerful and easy to use.

The integrated tools help to optimize the coding phase and increase the performance and quality of applications.

Object-oriented programming

All essential features of standard object-oriented programming are included in Automation Builders object-oriented programming:

- Better structured program code with “separation of concerns” and information hiding
- Flexible extensibility by new types of objects (e.g. software representations of new types of drives)
- Reuse of code for defining specialized sub-classes (inheritance), reuse of code operating on different implementations of an interface (polymorphism)

- New optimized editors for IEC programming languages
- Continuous Function Chart (CFC) with auto routing of connections between POU's, unrestricted definition and display of the execution order
- Structured Text (ST) with Support for quick editing with common help, such as grouping, collapsible tree structure, and indented brackets

Professional version control – management of the application project

Professional Version Control is an integrated link to the version control system Subversion (SVN). End users can use this tool to manage independently both the complete IEC 61131-3 project version, as well as the individual application objects. End users benefit from automated management of the source code when developing a project in various teams or over a long period of time.

Automation Builder

Virtual Commissioning Platform – virtual system testing

Automation Builder 2.0 introduces virtual system testing which allows machine builders and system integrators to simulate and automate all kinds of applications with minimum effort. This gives seamless testing of the complete system at an early stage, even when all the necessary hardware is not yet ready. Even complex systems can be built up quickly and efficiently, ensuring smooth interaction of all the components.

Virtual Commissioning Technology builds on ABB’s proven engineering tools RobotStudio and Automation Builder as basis for simulation. It lets you build simulation models from virtual devices and manage the virtual time and signal exchange between the virtual devices.

Virtual devices emulate real hardware. They function as real hardware, provide signals (onboard, local, fieldbus/remote IOs) and variables. Virtual time lets you control the execution of the simulation. Speed up, slow down or freeze the execution for testing and debugging.

Additional components can be included to these models. This allows to simulate the real system including physical inputs or actuators. The flexible architecture of the Virtual Commissioning Technology allows to extend your simulation to more advanced aspects, e.g. the dynamic system behavior.

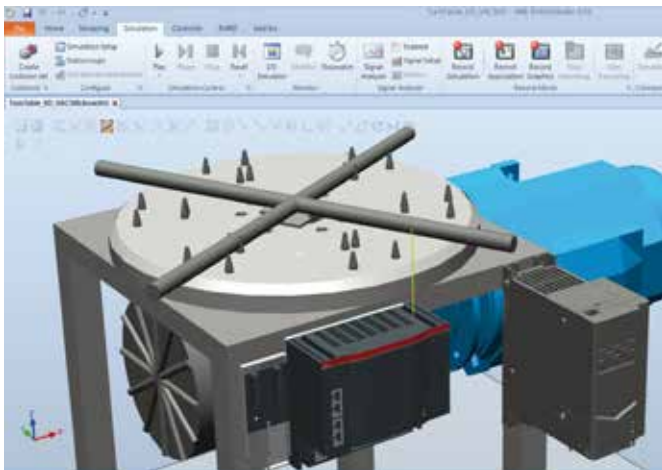

02

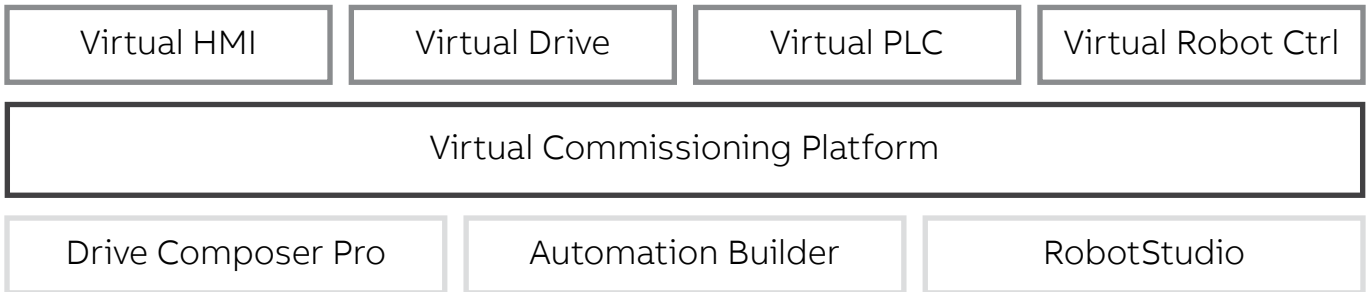

Save time

Reduce risk

Increase efficiency

Simulate effortless

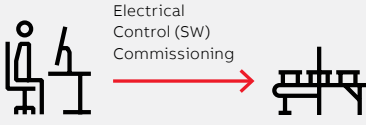

Debug realistic systems without real hardware

Ensure quality

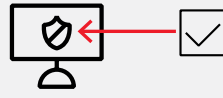

Verify logic, detect errors, prove quality

Ease operator training



3D simulation in best-in-class tool RobotStudio

Accelerate commissioning



Synchronized system integration using virtual time

Efficient re-use



Same data in simulation, reality and across projects

Convince your customers



Create insight and trust with functional models

Virtual Commissioning Technology – Benefits

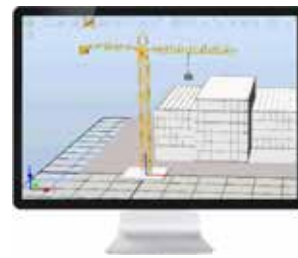

Virtual drive tuning: Drive composer pro

Drive engineering

- Start and connect virtual drives
- Set parameters and do adaptive programming offline
- Define load models

Virtual system testing: Automation Builder

Automation system engineering

- Configuration and programming of PLC, drives and HMIs
- Functional modelling of any devices, e.g. sensors, simple actuators, power trains (incl. gears, transformations, ...)
- Deployment of virtual PLCs, drives and HMIs
- Offline system testing without 3D

Virtual commissioning: RobotStudio

3D modelling and robot engineering

- Robot control configuration and programming
- Modelling of geometry and kinematics
- Modelling of component behavior, e.g. sensors and actuators
- Importing and connecting of configured PLCs, power trains (including drives) and other devices
- Communication with other virtual devices
- Deployment of virtual Robot Control
- 3D simulation

Virtual Commissioning Technology – Variants

Efficient simulation in three variants

Virtual Commissioning Technology comes in three variants to match your need

- Virtual drive tuning: Configure and tune your drive offline before connecting to a real drive.
- Virtual system testing: Go online to your automation system without real control hardware using familiar engineering tools.
- Virtual commissioning: Build 3D models of your system in RobotStudio and simulate the system behavior like it was real.

AC500-eCo

Entry level PLC solutions

057	Key features
058–061	Ordering data
062–069	Technical data
070–071	System data

PM556

ABB

D10	<input type="checkbox"/>	D14	<input type="checkbox"/>	D00	<input type="checkbox"/>	D04	<input type="checkbox"/>
D11	<input checked="" type="checkbox"/>	D15	<input checked="" type="checkbox"/>	D01	<input type="checkbox"/>	D05	<input type="checkbox"/>
D12	<input checked="" type="checkbox"/>	D16	<input type="checkbox"/>	D02	<input type="checkbox"/>		<input type="checkbox"/>
D13	<input type="checkbox"/>	D17	<input type="checkbox"/>	D03	<input type="checkbox"/>		<input type="checkbox"/>

10	<input type="checkbox"/>	14	<input checked="" type="checkbox"/>	18	<input type="checkbox"/>
11	<input checked="" type="checkbox"/>	15	<input type="checkbox"/>	19	<input type="checkbox"/>
12	<input checked="" type="checkbox"/>	16	<input type="checkbox"/>	110	<input type="checkbox"/>
13	<input type="checkbox"/>	17	<input type="checkbox"/>	111	<input type="checkbox"/>
				160	<input type="checkbox"/>

CPU PM556-TP-ETH

8DI 24VDC 6DO-T 24VDC 0.5A

MC 502
-INSERT
-PUSH

COM2

WARNING!
Use of incorrect
battery may
cause fire or
explosion



AC500-eCo

Key features

High performance variant with large memory available



- Up to 10 I/O modules connected to the CPU
- Compatible with all standard I/O modules (S500 and S500-eCo)
- Digital I/O module with configurable I/O available

- Three different types of terminal blocks available
- Integrated onboard I/O
- AC versions with integrated power supply

Comprehensive communication options:

- Ethernet for communication and web server for user defined visualization
- Up to two serial ports for decentralized I/O and communication

AC500-eCo

Ordering data

AC500-eCo CPUs

- 1 RS485 serial interface (2nd is optional)
- Centrally expandable with up to 10 I/O modules (standard S500 and/or S500-eCo modules can be mixed)
- Optional SD card adapter for data storage and program backup
- Variants with integrated Ethernet (Ethernet includes web server)
- Minimum cycle time per instruction: Bit 0.08 μ s, Word 0.1 μ s, Float-point 1.2 μ s.

Program memory kB	Onboard I/Os DI/DO/AI/AO	Relay /Transistor outputs	Integrated communication	Power supply	Type	Order code	Price	Weight (1 pce) kg
PM554: digital I/Os								
128	8 / 6 / - / -	Transistor	-	24 V DC	PM554-TP	1SAP120600R0001		0.300
128	8 / 6 / - / -	Relay	-	24 V DC	PM554-RP	1SAP120700R0001		0.400
128	8 / 6 / - / -	Relay	-	100-240 V AC	PM554-RP-AC	1SAP120800R0001		0.400
128	8 / 6 / - / -	Transistor	Ethernet	24 V DC	PM554-TP-ETH	1SAP120600R0071		0.400
PM556: digital I/Os, 512 kB program memory								
512	8 / 6 / - / -	Transistor	Ethernet	24 V DC	PM556-TP-ETH	1SAP121200R0071		0.400
PM564: digital and analog I/Os (1)								
128	6 / 6 / 2 / 1	Transistor	-	24 V DC	PM564-TP	1SAP120900R0001		0.300
128	6 / 6 / 2 / 1	Relay	-	24 V DC	PM564-RP	1SAP121000R0001		0.400
128	6 / 6 / 2 / 1	Relay	-	100-240 V AC	PM564-RP-AC	1SAP121100R0001		0.400
128	6 / 6 / 2 / 1	Transistor	Ethernet	24 V DC	PM564-TP-ETH	1SAP120900R0071		0.300
128	6 / 6 / 2 / 1	Relay	Ethernet	24 V DC	PM564-RP-ETH	1SAP121000R0071		0.400
128	6 / 6 / 2 / 1	Relay	Ethernet	100-240 V AC	PM564-RP-ETH-AC	1SAP121100R0071		0.400
PM566: digital and analog I/Os, 512 kB program memory (1)								
512	6 / 6 / 2 / 1	Transistor	Ethernet	24 V DC	PM566-TP-ETH	1SAP121500R0071		0.400

Terminal blocks (9 and 11 poles) are necessary for each AC500-eCo I/O. The terminal blocks must be ordered separately.

(1) All analog inputs on PM564 and PM566 can be configured as digital inputs.



PM554



PM556



PM564



PM566

AC500-eCo

Ordering data

S500-eCo I/O modules

- For central expansion of the AC500 or AC500-eCo CPUs
- For decentralized expansion in combination with communication interface module DC551-CS31, CI52x-MODTCP, PROFINET CI50x modules, CI592-CS31, PROFIBUS modules CI54x, EtherCAT modules CI51x, and CANopen modules CI58x (not usable with DC505-FBP module and CI590-CS31-HA).

Digital I/O

- DC: Channels can be configured individually as inputs or outputs.

Number of DI/DO/DC	Input signal	Output type	Output signal	Terminal block required		Type	Order code	Price	Weight (1 pce) kg
				9 poles	11 poles				
8 / - / -	24 V DC	-	-	1	-	DI561	1TNE968902R2101		0.12
16 / - / -	24 V DC	-	-	1	1	DI562	1TNE968902R2102		0.12
8 / - / -	100-240 V AC	-	-	1	1	DI571	1TNE968902R2103		0.15
16 / - / -	100-240 V AC	-	-	1	1	DI572	1SAP230500R0000		0.19
- / 8 / -	-	Transistor	24 V DC, 0.5 A	-	1	DO561	1TNE968902R2201		0.12
- / 16 / -	-	Transistor	24 V DC, 0.5 A	1	1	DO562	1SAP230900R0000		0.16
- / 8 / -	-	Relay	24 V DC, 120 / 240 V AC, 2 A	-	1	DO571	1TNE968902R2202		0.15
- / 8 / -	-	Triac	100-240 V AC, 0.3 A	1	1	DO572	1TNE968902R2203		0.12
- / 16 / -	-	Relay	24 V DC, 120 / 240 V AC, 2 A	1	1	DO573	1SAP231300R0000		0.19
8 / 8 / -	24 V DC	Transistor	24 V DC, 0.5 A	1	1	DX561	1TNE968902R2301		0.12
8 / 8 / -	24 V DC	Relay	24 V DC, 120 / 240 V AC, 2 A	1	1	DX571	1TNE968902R2302		0.15
- / - / 16	24 V DC	Transistor	24 V DC, 0.1A	HE10-20	-	DC561	1TNE968902R2001		0.12
- / - / 16	24 V DC	Transistor	24 V DC, 0.5 A	1	1	DC562	1SAP231900R0000		0.15

Terminal blocks (9 or 11 poles) are necessary for each S500-eCo I/O. The terminal blocks must be ordered separately.

Analog I/O

- Each channel can be configured individually
- Resolution:
 - AI561, AO561, AX561: 12 bits/11 bits + sign
 - AI562, AI563: 15 bits + sign.

Number of AI/AO	Input signal	Output signal	Terminal block required		Type	Order code	Price	Weight (1 pce) kg
			9 poles	11 poles				
4 / 0	±2.5 V, ±5 V, 0...5 V, 0...10 V, 0...20 mA, 4...20 mA	-	1	1	AI561	1TNE968902R1101		0.12
2 / 0	PT100, PT1000, Ni100, Ni1000, Resistance: 150 Ω, 300 Ω	-	-	1	AI562	1TNE968902R1102		0.12
4 / 0	S, T, R, E, N, K, J, Voltage range: ±80 mV	-	1	1	AI563	1TNE968902R1103		0.12
0 / 2	-	-10...+10 V, 0...20 mA, 4...20 mA	-	1	AO561	1TNE968902R1201		0.12
4 / 2	±2.5 V, ±5 V, 0...5 V, 0...10 V, 0...20 mA, 4...20 mA	-10...+10 V, 0...20 mA, 4...20 mA	1	1	AX561	1TNE968902R1301		0.13

Terminal blocks (9 or 11 poles) are necessary for each S500-eCo I/O. The terminal blocks must be ordered separately.



DI561

AI562

AX561

AC500-eCo

Ordering data

Positioning module

- For central expansion of the AC500 or AC500-eCo CPUs
- For decentralized expansion in combination with communication interface modules CI50X-PNIO or CI54X-DP
- The FM562 module provides Pulse Train Outputs for 2 axes. Profile generator integrated.

Number of axis	Input signal	Output signal	Terminal block required		Type	Order code	Price	Weight (1 pce) kg
			9 poles	11 poles				
2	4 digital inputs 24 V (2 per axis)	4 pulse outputs RS422 (2 per axis)	1	1	FM562	1SAP233100R0001		0.15

Terminal blocks (9 or 11 poles) are necessary for each S500-eCo I/O. The terminal blocks must be ordered separately. Library PS552-MC-E is required for programming this module.



FM562

Accessories

Description	Type	Order code	Price	Weight (1 pce) kg
SD Memory Card 2 GB needs the MC503 option	MC502	1SAP180100R0001		0.020
SD Memory Card adapter	MC503	1TNE968901R0100		0.010
Programming cable USB => RS485 Sub-D, 3 m	TK503	1TNE968901R1100		0.400
Programming cable USB => RS485 Terminal block, 3 m	TK504	1TNE968901R2100		0.400
RS485 isolator, Sub-D 9 poles / Terminal 5 poles for COM1	TK506	1SAP186100R0001		0.080
Real time clock option board, battery CR2032 not included	TA561-RTC (1)	1SAP181400R0001		0.007
RS485 serial adapter COM2, pluggable screw terminal block included	TA562-RS	1TNE968901R4300		0.007
Combined real time clock option with RS485 serial adapter COM2, pluggable screw terminal block, included	TA562-RS-RTC (1)	1SAP181500R0001		0.012
Wall mounting accessory for AC500-eCo CPU and S500-eCo I/O modules (100 pieces per case)	TA566	1TNE968901R3107		0.450
Set of accessories: 6 x plastic cover for option slot, 6 x 5 pole terminal block, 6 x 5 pole screw terminal block for COM2 serial interface.	TA570	1TNE968901R3203		0.090
Digital input simulator for onboard I/O of CPU, 6 x switch, 24 V DC	TA571-SIM	1TNE968903R0203		0.040

(1) Standard battery CR 2032 has to be purchased separately.



TK506



TA561-RTC



TA562-RS



TA562-RS-RTC



TA570

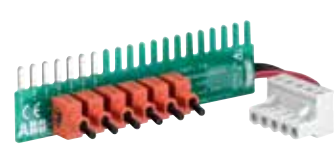

TA571-SIM

AC500-eCo

Ordering data

Terminal blocks for S500-eCo I/O modules and AC500-eCo CPUs

Number of poles	Connection type	Cable entry	Type	Order code	Price	Weight (1 pce) kg
9	Screw	Side	TA563-9	1TNE968901R3101		0.017
11	Screw	Side	TA563-11	1TNE968901R3102		0.020
9	Screw	Front	TA564-9	1TNE968901R3103		0.026
11	Screw	Front	TA564-11	1TNE968901R3104		0.035
9	Spring	Front	TA565-9	1TNE968901R3105		0.016
11	Spring	Front	TA565-11	1TNE968901R3106		0.020

 Only ABB terminal blocks must be used with AC500-eCo.
Sales package for these terminal blocks = 6.



TA563-9



TA564-11



TA565-9

AC500-eCo

Technical data

AC500-eCo CPUs

Type	PM554-TP	PM554-RP	PM554-RP-AC		PM554-TP-ETH	PM556-TP-ETH
Supply voltage	24 V DC		100-240 V AC		24 V DC	
Current consumption on	24 V DC		100 V AC	240 V AC	24 V DC	
Min. (module alone)	0.06 A	0.08 A	0.02 A	0.012 A	0.07 A	0.07 A
Max. (I/Os)	0.18 A	0.22 A	0.2 A	0.11 A	0.19 A	0.19 A
Program memory	128 kB					512 kB
Integrated data memory	14 kB thereof 2 kB saved					130 kB thereof 2 kB saved
Web server's data for user RAM disk	–				512 kB	1024 kB
Data buffering (of saved data)	flash memory					
Real-time clock (option with battery back-up) (1)	•					
Program execution						
Cyclical	•					
Time controlled	•					
Multi tasking	no, 1 task + 1 interrupt task max.					
Interruption	•					
User program protection by password	•					
Cycle time for 1 instruction (minimum)						
Binary	0.08 µs					
Word	0.1 µs					
Floating	1.2 µs					
Onboard digital inputs						
Channels	8 (including 2 counter inputs, or up to 4 interrupt inputs)					
Signal voltage	24 V DC					
Onboard digital outputs						
Channels	6 (including 2 PWM outputs for types with transistor outputs)					
Relay / Transistor	Transistor	Relay	Relay	Relay	Transistor	Transistor
Rated voltage	24 V DC	240 V AC	240 V AC	240 V AC	24 V DC	24 V DC
Nominal current per channel	0.5 A	2 A resistive	2 A resistive	2 A resistive	0.5 A	0.5 A
Onboard analog outputs						
Channels	-					
signal ranges	-					
Onboard analog inputs						
Channels	-					
signal ranges	-					
Max. number of centralized inputs/outputs						
Max. number of extension modules on I/O bus	up to max. 10 (S500 and/or S500-eCo modules allowed)					
Digital	inputs	320 + 8				
	outputs	320 + 6				
Analog	inputs	160				
	outputs	160				
Max. number of decentralized inputs/outputs						
I/O modules	decentralized	on CS31 bus: up to 31 stations with up to 120 DI / 120 DO each or up to 32 AI/32 AO per station				
Internal interfaces						
COM1						
RS485	•					
Sub-D connection	•					
Programming, Modbus-RTU, ASCII, CS31	•					
COM2 (option) (2)						
RS485	•					
Terminal block	•					
Programming, Modbus-RTU, ASCII	•					
Ethernet						
RJ45	–					•
Ethernet functions: Programming, Modbus TCP/IP, UDP/IP, integrated Web server, DHCP, FTP server, SNTP client	–					•
SMTP	–					•
RUN/STOP switch	•					
LED display for power, status and error	•					
Approvals	see detailed overview page 220 or www.abb.com/plc					

(1) Real-time clock requires optional TA561-RTC or TA562-RS-RTC.

(2) COM2 requires TA562-RS-RTC or TA562-RS.

AC500-eCo

Technical data

AC500-eCo CPUs

Type	PM564-TP	PM564-RP	PM564-RP-AC	
Supply voltage	24 V DC		100-240 V AC	
Current consumption on	24 V DC		100 V AC	240 V AC
Min. (module alone)	0.095 A	0.11 A	0.02 A	0.011 A
Max. (I/Os)	0.21 A	0.24 A	0.21 A	0.125 A
Program memory	128 kB			
Integrated data memory	14 kB thereof 2 kB saved			
Web server's data for user RAM disk				
Data buffering (of saved data)	flash memory			
Real-time clock (option with battery back-up) (1)	•			
Program execution				
Cyclical	•			
Time controlled	•			
Multi tasking	no, 1 task + 1 interrupt task max.			
Interruption	•			
User program protection by password	•			
Cycle time for 1 instruction (minimum)				
Binary	0.08 µs			
Word	0.1 µs			
Floating	1.2 µs			
Onboard digital inputs				
Channels	6 (including 2 counter inputs, or up to 4 interrupt inputs)			
Signal voltage	24 V DC			
Onboard digital outputs				
Channels	6 (including 2 PWM outputs for types with transistor outputs)			
Relay / Transistor	Transistor	Relay	Relay	
Rated voltage	24 V DC	240 V AC	240 V AC	
Nominal current per channel	0.5 A	2 A resistive	2 A resistive	
Onboard analog inputs				
Channels	2			
signal ranges	0...10 V / can be configured as digital input 24 V DC			
Onboard analog outputs				
Channels	1			
signal ranges	0...10 V / 0...20 mA / 4...20 mA			
Max. number of centralized inputs/outputs				
Max. number of extension modules on I/O bus	up to max. 10 (S500 and/or S500-eCo modules allowed)			
Digital	inputs	320 + 8		
	outputs	320 + 6		
Analog	inputs	160 + 2		
	outputs	160 + 1		
Max. number of decentralized inputs/outputs				
I/O modules	decentralized	on CS31 bus: up to 31 stations with up to 120 DI / 120 DO each or up to 32 AI/32 AO per station		
Internal interfaces				
COM1				
RS485	•			
Sub-D connection	•			
Programming, Modbus-RTU, ASCII, CS31	•			
COM2 (option) (2)				
RS485	•			
Terminal block	•			
Programming, Modbus-RTU, ASCII	•			
Ethernet				
RJ45	–			
Ethernet functions: Programming, Modbus TCP/IP, UDP/IP, integrated Web server, DHCP, FTP server, SNMP client	–			
SMTP	–			
RUN/STOP switch	•			
LED display for power, status and error	•			
Approvals	see detailed overview page 220 or www.abb.com/plc			

(1) Real-time clock requires optional TA561-RTC or TA562-RS-RTC.

(2) COM2 requires TA562-RS-RTC or TA562-RS.

AC500-eCo

Technical data

AC500-eCo CPUs

Type	PM564-TP-ETH	PM566-TP-ETH	PM564-RP-ETH	PM564-RP-ETH-AC
Supply voltage	24 V DC			100-240 V AC
Current consumption on	24 V DC			100 V AC 240 V AC
Min. (module alone)	0.10 A	0.10 A	0.12 A	0.023 A 0.014 A
Max. (I/Os)	0.22 A	0.22 A	0.25 A	0.22 A 0.13 A
Program memory	128 kB	512 kB	128 kB	
Integrated data memory	14 kB thereof 2 kB saved	130 kB thereof 2 kB saved	14 kB thereof 2 kB saved	
Web server's data for user RAM disk	512 kB	1024 kB	512 kB	
Data buffering (of saved data)	flash memory			
Real-time clock (option with battery back-up) (1)	•			
Program execution				
Cyclical	•			
Time controlled	•			
Multi tasking	no, 1 task + 1 interrupt task max.			
Interruption	•			
User program protection by password	•			
Cycle time for 1 instruction (minimum)				
Binary	0.08 µs			
Word	0.1 µs			
Floating	1.2 µs			
Onboard digital inputs				
Channels	6 (including 2 counter inputs, or up to 4 interrupt inputs)			
Signal voltage	24 V DC			
Onboard digital outputs				
Channels	6 (including 2 PWM outputs for types with transistor outputs)			
Relay / Transistor	Transistor	Transistor	Relay	Relay
Rated voltage	24 V DC	24 V DC	240 V AC	240 V AC
Nominal current per channel	0.5 A	0.5 A	2 A resistive	2 A resistive
Onboard analog inputs				
Channels	2			
signal ranges	0...10 V / can be configured as digital input 24 V DC			
Onboard analog outputs				
Channels	1			
signal ranges	0...10 V / 0...20 mA / 4...20 mA			
Max. number of centralized inputs/outputs				
Max. number of extension modules on I/O bus	up to max. 10 (S500 and/or S500-eCo modules allowed)			
Digital	inputs	320 + 8		
	outputs	320 + 6		
Analog	inputs	160 + 2		
	outputs	160 + 1		
Max. number of decentralized inputs/outputs				
I/O modules	decentralized	on CS31 bus: up to 31 stations with up to 120 DI / 120 DO each or up to 32 AI/32 AO per station		
Internal interfaces				
COM1				
RS485	•			
Sub-D connection	•			
Programming, Modbus-RTU, ASCII, CS31	•			
COM2 (option) (2)				
RS485	•			
Terminal block	•			
Programming, Modbus-RTU, ASCII	•			
Ethernet				
RJ45	•			
Ethernet functions: Programming, Modbus TCP/IP, UDP/IP, integrated Web server, DHCP, FTP server, SNMP client	•			
SMTP	–	•	–	–
RUN/STOP switch	•			
LED display for power, status and error	•			
Approvals	see detailed overview page 220 or www.abb.com/plc			

(1) Real-time clock requires optional TA561-RTC or TA562-RS-RTC.

(2) COM2 requires TA562-RS-RTC or TA562-RS.

AC500-eCo

Technical data

Digital S500-eCo I/O modules

Type	DI561	DI562	DI571	DI572	DO561	DO562
Supply voltage	–	–	–	–	24 V DC	24 V DC
Current consumption on UP						
Max. (without load current)	–	–	–	–	0.005 A	0.005 A
Number of channels per module						
Digital						
inputs	8	16	8 (AC)	16 (AC)	–	–
outputs	–	–	–	–	8	16
Configurable as Input or Output DC	–	–	–	–	–	–
Relay / Transistor	–	–	–	–	Transistor	Transistor
Additional configuration of channels as:						
Fast Counter	no					not applicable
Digital inputs						
Input signal voltage	24 V DC	24 V DC	100-240 V AC	100-240 V AC	–	–
Input time delay	typically 4...8 ms	typically 4...8 ms	typically 15 ms / 30 ms	typically 15 ms / 30 ms	–	–
Input current per channel						
At Input voltage						
24 V DC	typically 5 mA	typically 5 mA	–	–	–	–
5 V DC	typically 1 mA	typically 1 mA	–	–	–	–
15 V DC	> 2.5 mA	> 2.5 mA	–	–	–	–
30 V DC	< 8 mA	< 8 mA	–	–	–	–
40 V AC	–	–	< 3 mA	< 3 mA	–	–
164 V AC	–	–	> 6 mA	> 6 mA	–	–
Output current						
Nominal current per channel	–	–	–	–	0.5 A at UP = 24 V	
Maximum (total current of all channels)	–	–	–	–	4 A	8 A
Residual current at signal state 0	–	–	–	–	< 0.5 mA	
Demagnetization when switching off inductive loads	–	–	–	–	must be provided externally	
Switching frequency						
For resistive load	–	–	–	–	limited by CPU cycle time	
For inductive load	–	–	–	–	max. 0.5 Hz	
For lamp load	–	–	–	–	max. 11 Hz at max. 5 W	
Short circuit / overload proofness	–	–	–	–	no	
Overload indication (I > 0.7 A)	–	–	–	–	no	
Output current limiting	–	–	–	–	no	
Proofness against reverse feeding of 24 V signals	–	–	–	–	no	
Contact rating						
For resistive load, max.	–	–	–	–	–	–
For inductive load, max.	–	–	–	–	–	–
For lamp load	–	–	–	–	–	–
Lifetime (switching cycles)						
Mechanical lifetime	–	–	–	–	–	–
Lifetime under load	–	–	–	–	–	–
Maximum cable length for connected process signals						
Cable						
shielded	500 m					
unshielded	300 m				150 m	
Potential isolation						
Per module	●	●	●	●	●	●
Between the channels						
input	–	per group of 8	●	per group of 8	–	–
output	–	–	–	–	–	–
Voltage supply for the module's logic	internal via I/O bus					
Fieldbus connection						
Suitable communication interface module	CI501-PNIO, CI502-PNIO, CI504-PNIO, CI506-PNIO, CI511-ETHCAT, CI512-ETHCAT, CI541-DP, CI542-DP, CI581-CN, CI582-CN, DC551-CS31, CI592-CS31, CI521-MODTCP, CI522-MODTCP					

AC500-eCo

Technical data

Digital S500-eCo I/O modules

Type	D0571	D0572	D0573
Supply voltage	24 V DC		
Current consumption on UP			
Max. (without load current)	0.050 A	–	0.050 A
Number of channels per module			
Digital			
inputs	–	–	–
outputs	8	8	16
Configurable as Input or Output DC	–	–	–
Relay / Transistor	Relay (n.o.)	Triac (AC)	Relay (n.o.)
Process voltage			
DC	24 V	–	–
Digital inputs			
Input signal voltage	–	–	–
Input time delay	–	–	–
Input current per channel			
At Input voltage			
24 V DC	–	–	–
5 V DC	–	–	–
15 V DC	–	–	–
30 V DC	–	–	–
Output current			
Nominal current per channel	2 A (24 V DC / 120 V AC / 240 V AC, resistive load)	0.3 A at 100...240 V AC	2 A (24 V DC / 120 V AC / 240 V AC, resistive load)
Maximum (total current of all channels)	2 x 8 A	2.4 A / 8 x 0.3 A	max 10 A per group (20 A per module)
Residual current at signal state 0	–	1.1 mA rms at 132 V AC and 1.8 mA rms at 264 V AC	–
Demagnetization when switching off inductive loads	must be performed externally		
Switching frequency			
For resistive load	1 Hz max.	10 Hz max.	1 Hz max.
For inductive load	–	–	–
For lamp load	1 Hz max.	10 Hz max.	1 Hz max.
Short circuit / overload proofness	no		
Overload indication (I > 0.7 A)	no		
Output current limiting	no		
Proofness against reverse feeding of 24 V signals	yes	–	yes
Contact rating			
For resistive load, max.	2 A	0.3 A	2 A
For inductive load, max.	–	–	–
For lamp load	200 W at 230 V AC 30 W at 24 V DC	–	200 W at 230 V AC 30 W at 24 V DC
Lifetime (switching cycles)			
Mechanical lifetime	100 000	–	100 000
Lifetime under load	100 000 at rated load	–	100 000 at rated load
Maximum cable length for connected process signals			
Cable			
shielded	500 m		
unshielded	150 m		
Potential isolation			
Per module	between outputs and logic	●	between outputs and logic
Between the channels			
input	–	–	–
output	per group of 4	●	per group of 8
Voltage supply for the module's logic	internal via I/O bus		
Fieldbus connection			
Suitable communication interface module	CI501-PNIO, CI502-PNIO, CI504-PNIO, CI506-PNIO, CI511-ETHCAT, CI512-ETHCAT, CI541-DP, CI542-DP, CI581-CN, CI582-CN, DC551-CS31, CI592-CS31, CI521-MODTCP, CI522-MODTCP		

AC500-eCo

Technical data

Digital S500-eCo I/O modules

Type		DX561	DX571	DC561	DC562
Supply voltage		24 V DC			
Current consumption on UP					
Max. (without load current)		0.005 A	0.050 A	0.010 A	0.010 A
Number of channels per module					
Digital	inputs	8	8	–	–
	outputs	8	8	–	–
Configurable as Input or Output DC		–	–	16	16
Relays / Transistor		Transistor	Relay (n.o.)	Transistor	Transistor
Process voltage					
DC		24 V	24 V	24 V	24 V
Digital inputs					
Input signal voltage		24 V DC	24 V DC	24 V DC	24 V DC
Input time delay		typically 4...8 ms			typically 8 ms
Input current per channel					
At Input voltage	24 V DC	typically 5 mA	typically 5 mA	typically 4 mA	typically 5 mA
	5 V DC	< 1 mA	< 1 mA	< 1 mA	typically 1 mA
	15 V DC	> 2.5 mA	> 2.5 mA	> 2.5 mA	> 2.5 mA
	30 V DC	< 6.5 mA	< 6.5 mA	< 6 mA	< 8 mA
Output current					
Nominal current per channel		0.5 A at UP = 24 V DC	2 A (24 V DC / 120 V AC / 240 V AC, resistive load)	0.1 A at UP = 24 V DC	0.5 A at UP = 24 V DC
Maximum (total current of all channels)		4 A	2 x 8 A	1.6 A	8 A
Residual current at signal state 0		< 0.5 mA	–	< 0.5 mA	< 0.5 mA
Demagnetization when switching off inductive loads		must be performed externally			
Switching frequency					
For resistive load		Limited by CPU cycle time	1 Hz max.	Limited by CPU cycle time	
For inductive load		0.5 Hz max.	–	0.5 Hz max.	0.5 Hz max.
For lamp load		11 Hz max. at max. 5 W	1 Hz max.	–	11 Hz max. at max. 5 W
Short circuit / overload proofness		no			
Overload indication (I > 0.7 A)		no			
Output current limiting		no			
Proofness against reverse feeding of 24 V signals		no	yes	no	no
Contact rating					
For resistive load, max.		–	2 A	–	–
For inductive load, max.		–	–	–	–
For lamp load		–	200 W at 230 V AC 30 W at 24 V DC	–	–
Lifetime (switching cycles)					
Mechanical lifetime		–	100 000	–	–
Lifetime under load		–	100 000 at rated load	–	–
Maximum cable length for connected process signals					
Cable	shielded	500 m			
	unshielded	150 m			
Potential isolation					
Per module		●	–	●	●
Between the channels	input	–	per group of 8	–	–
	output	–	per group of 4	–	–
Voltage supply for the module's logic		internal via I/O bus			
Fieldbus connection					
Suitable communication interface module		CI501-PNIO, CI502-PNIO, CI504-PNIO, CI506-PNIO, CI511-ETHCAT, CI512-ETHCAT, CI541-DP, CI542-DP, CI581-CN, CI582-CN, DC551-CS31, CI592-CS31, CI521-MODTCP, CI522-MODTCP			

AC500-eCo

Technical data

Analog S500-eCo I/O modules

Type	AI561	AO561	AX561	AI562	AI563
Supply voltage	24 V DC				
Current consumption on UP					
Max. (without load current)	0.100 A	0.100 A	0.140 A	0.040 A	0.100 A
Number of channels per module					
Analog					
inputs	4	–	4	2	4
outputs	–	2	2	–	–
Inputs, individually configurable					
-2.5...+2.5 V	11 bits + sign	•	–	•	–
-5...+5 V	11 bits + sign	•	–	•	–
-10...+10 V	11 bits + sign	–	–	–	–
0...5 V	12 bits	•	–	•	–
0...10 V	12 bits	•	–	•	–
0...20 mA, 4...20 mA	12 bits	•	–	•	–
RTD					
Pt100	-50...+400 °C (2/3-wire)	–	–	•	–
Pt1000	-50...+400 °C (2/3-wire)	–	–	•	–
Ni100 / Ni1000	-50...+150 °C (2/3-wire)	–	–	•	–
Resistor	0...150 Ω/0...300 Ω	–	–	•	–
Thermocouple	Types J, K, T, N, S, E, R	–	–	–	•
Voltage	-80...+80 mV	–	–	–	•
Outputs, individually configurable					
-10...+10 V	11 bits + sign	–	•	–	–
0...20 mA	12 bits	–	•	–	–
4...20 mA	12 bits	–	•	–	–
Potential isolation					
Per module	–	–	–	•	•
Fieldbus connection					
Suitable communication interface module	CI501-PNIO, CI502-PNIO, CI504-PNIO, CI506-PNIO, CI511-ETHCAT, CI512-ETHCAT, CI541-DP, CI542-DP, CI581-CN, CI582-CN, DC551-CS31, CI592-CS31, CI521-MODTCP, CI522-MODTCP				

AC500-eCo

Technical data

FM562 positioning module

The FM562 module contains Pulse Train Outputs for 2 axes. Profile generator for simple motion control tasks are integrated. The RS422 outputs allow a direct connection to Stepper- or Servo drives. Function blocks in PLCopen motion control style allow the integration of the module in an application. These function blocks are contained in the library PS552-MC-E.

Type	FM562	
Functionality		
Number of axis	2	
Digital inputs	2 digital inputs per axis Function: for axis enable or limit switch	
Pulse outputs	Modes cw/ccw or pulse/direction Built in profile generators	
Data of the digital inputs		
Signal voltage	24 V DC	
Input current at 24 V DC	typically 5 mA	
Potential isolation	by groups of 2	
Data of pulse outputs		
Signal	RS422 (differential)	
Frequency range	0...250 kHz	
Potential isolation	RS422 outputs of both axis in one group isolated against the inputs, the process voltage and the PLC CPU logic	
Maximum cable length for digital inputs		
Cable	shielded	500 m
	unshielded	300 m
Maximum cable length for pulse outputs		
Cable	shielded	300 m
	unshielded	30 m
Process voltage UP		
Nominal voltage	24 V DC	
Current consumption on UP	typically 0.04 A	
Reverse polarity protection	●	
Potential isolation		
Per module	●	
Voltage supply for the internal logic	From UP / ZP with isolation	
Fieldbus connection		
Suitable communication interface module	CI501-PNIO, CI502-PNIO, CI504-PNIO, CI506-PNIO, CI541-DP, CI542-DP	

AC500-eCo

System data

Environmental Conditions

Process and supply voltages

24 V DC	Voltage	24 V (-15%, +20%)
	Protection against reverse polarity	yes
100 V...240 V AC Wide Range Supply	Voltage	100...240 V (-15 %, +10 %)
	Frequency	50/60 Hz (-6 %, +4%)
Allowed interruptions of power supply	DC supply	Interruption < 10 ms, time between 2 interruptions > 1 s, PS2
	AC supply	Interruption < 0.5 periods, time between 2 interruptions > 1 s

Important: Exceeding the maximum process and supply voltages could lead to unrecoverable damage of the system. The system could be destroyed. For the supply of the modules, power supply units according to PELV or SELV specifications must be used. The creepage distances and clearances meet the requirements of the overvoltage category II, pollution degree 2.

Temperature

Operating	0 °C ... +60 °C	horizontal mounting of modules
	0 °C ... +40 °C	vertical mounting of modules and output load reduced to 50 % per group
Storage / Transport	-40 °C ... +70 °C	

Humidity

Operating / Storage	Max 95 % r. H. without condensation
---------------------	-------------------------------------

Air pressure

Operating	-1000 m ... 2000 m (1080 hPa ... 800 hPa)
Storage	<3500 m (>660 hPa)

Electromagnetic Compatibility

Radiated emission (radio disturbances)	Yes, according to: CISPR 16-2-3
Conducted emission (radio disturbances)	Yes, according to: CISPR 16-2-1, CISPR 16-1-2
Electrostatic discharge (ESD)	Yes, according to: IEC 61000-4-2, zone B, criterion B Electrostatic voltage in case of air discharge: 8 kV Electrostatic voltage in case of contact discharge: 6 kV
Fast transient interference voltages (burst)	Yes, according to: IEC 61000-4-4, zone B, criterion B Supply voltage units (DC): 2 kV Supply voltage units (AC): 2 kV Digital inputs/outputs (24 V DC): 1 kV Digital inputs/outputs (100...240 V AC): 2 kV Analog inputs/outputs: 1 kV Communication lines shielded: 1 kV I/O supply (DC-out): 1 kV
High energy transient interference voltages (surge)	Yes, according to: IEC 61000-4-5, zone B, criterion B Supply voltage units (DC): 1 kV CM* / 0.5 kV DM* Supply voltage units (AC): 2 kV CM* / 1 kV DM* Digital inputs/outputs (24 V DC): 1 kV CM* / 0.5 kV DM* Digital inputs/outputs (100...240 V AC): 2 kV CM* / 1 kV DM* Analog inputs/outputs: 1 kV CM* / 0.5 kV DM* Communication lines shielded: 1 kV CM* I/O supply (DC-out): 0.5 kV CM* / 0.5 kV DM* * CM = Common Mode, * DM = Differential Mode
Influence of radiated disturbances	Yes, according to: IEC 61000-4-3, zone B, criterion A Test field strength: 10 V/m
Influence of line-conducted interferences	Yes, according to: IEC 61000-4-6, zone B, criterion A Test voltage: 10 V

AC500-eCo

System data

Environmental Conditions

Influence of power frequency magnetic fields	Yes, according to:
	IEC 61000-4-8, zone B, criterion A
	30 A/m 50 Hz
	30 A/m 60 Hz

In order to prevent malfunctions, it is recommended, that the operating personnel discharge themselves prior to touching communication connectors or perform other suitable measures to reduce effects of electrostatic discharges.

WARNING!

Risk of malfunctions and damages to persons!

Unused slots for Communication Modules are not protected against accidentally touch. Dust and Dirt may cause contact problems and malfunctions.

I/O-Bus connectors must not be touched during operation.

Environmental Tests

Storage	IEC 60068-2-1 Test Ab: cold withstand test -40 °C / 16 h
	IEC 60068-2-2 Test Bb: dry heat withstand test +70 °C / 16 h
Humidity	IEC 60068-2-30 Test Db: Cyclic (12 h / 12 h) Damp-Heat Test 55 °C, 93 % r. H. / 25 °C, 95 % r. H., 2 cycles
Vibration resistance	IEC 61131-2 / IEC 60068-2-6: 5 Hz ... 150 Hz, 1 g (with SD Memory Card inserted)
Shock resistance	IEC 60068-2-27: all 3 axes 15 g, 11 ms, half-sinusoidal

Mechanical Data

Wiring method	Spring terminals / Screw terminals	
Degree of protection	IP 20	
Vibration resistance	Yes, according to:	
	IEC 61131-2	
	IEC 60068-2-6	
Shock resistance	Yes, according to:	
	IEC 61131-2	
	IEC 60068-2-27	
Assembly position	Horizontal	
	Vertical	
Assembly on DIN rail	DIN rail type	According to IEC 60715
		35 mm, depth 7.5 mm or 15 mm
Assembly with screws	Screw diameter	4 mm
	Fastening torque	1.2 Nm

03

Main dimensions mm, inches

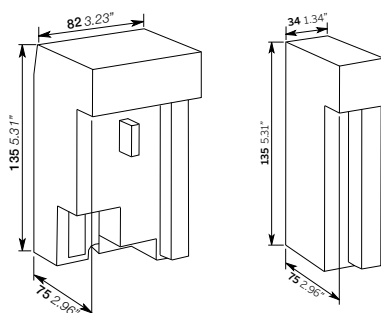

AC500

High performance
modular PLC

075	Key features
076–087	Ordering data
088–116	Technical data
117–119	System data

ABB

PM592

SYS
BATT
I/O-Bus

run

ETH
FBP
COM1
COM2

PWR



RUN



ERR



RUN

DIAG

VAL

CFG

ESC



OK



WARNING

Use of
incorrect
battery may
cause fire or
explosion.

MC
502

← INSERT
→ PUSH

UP 24VDC 10W

CPU

AC500

Key features



- A high performance PLC:
 - Large memory up to 160 MB
 - Highly modular
 - From 8 to +80 000 I/Os
 - More communication possibilities (Ethernet, Internet, PROFINET, PROFIBUS, Modbus, CANopen, EtherCAT, EthernetIP, OPC UA, OPC DA, IEC 60870-5-104, IEC61850, ...)

- Common AC500 platform benefits: Automation Builder engineering suite, I/O modules, scalable and flexible

- Eight programming languages available (five IEC61131-3, CFC, C-code and C++)
- Object oriented Engineering
- Virtual controller
- Webvisu
- Data logging
- SD card for program back-up
- High Availability (HA) option
- Screw or spring terminal for I/Os
- Extensive programming libraries

AC500

Ordering data

AC500 CPUs

- 2 internal serial interfaces, RS232 / RS485 configurable
- Display and 8 function keys for diagnosis and status
- Centrally expandable with up to 10 I/O modules, 320 I/Os (S500 and/or S500-eCo modules allowed)
- Simultaneous operation of up to 4 external communication modules in any desired combination
- Optional SD card for data storage and program backup
- Can also be used as slave on PROFIBUS DP, CANopen or PROFINET IO using CM582-DP, CM588-CN or CM589-PNIO slave communication modules
- Ethernet version provides web server and IEC 60870-5-104 remote control protocol

Program memory kB	Cycle time in μ s per instruction min. Bit/Word/Float. point	Integrated communication	Type	Order code	Price	Weight (1 pce) kg
128	0.06 / 0.09 / 0.7	2 x serial	PM572	1SAP130200R0200		0.135
512	0.06 / 0.09 / 0.7	Ethernet (2), 2 x serial	PM573-ETH (1)	1SAP130300R0271		0.150
512	0.05 / 0.06 / 0.5	2 x serial	PM582	1SAP140200R0201		0.135
1024	0.05 / 0.06 / 0.5	Ethernet (2), 2 x serial	PM583-ETH (1)	1SAP140300R0271		0.150
1024	0.004 / 0.008 / 0.008	Ethernet (2), 2 x serial	PM585-ETH (1)	1SAP140500R0271		0.150
2048	0.002 / 0.004 / 0.004	Ethernet (2), 2 x serial	PM590-ETH (1)	1SAP150000R0271		0.150
2048	0.002 / 0.004 / 0.004	ARCNET BNC, 2 x serial	PM590-ARCNET	1SAP150000R0261		0.150
4096	0.002 / 0.004 / 0.004	Ethernet (2), 2 x serial	PM591-ETH (1)	1SAP150100R0271		0.150
4096	0.002 / 0.004 / 0.004	2 x Ethernet (2), 1 x serial	PM591-2ETH (1)(4)	1SAP150100R0277		0.150
4096	0.002 / 0.004 / 0.004	Ethernet (2), 2 x serial	PM592-ETH (1)(3)	1SAP150200R0271		0.150

AC500 Machine controller kits

- Complete product bundle providing all the needed devices for a machine controller delivered under one single order code

Program memory kB	Cycle time in μ s per instruction min. Bit/Word/Float. point	Contents / Integrated communication	Type	Order code	Price	Weight (1 pce) kg
1024	0.004 / 0.008 / 0.008	PM585-ETH, CM579-ETHCAT, TB511-ETH Ethernet (2), 2 x serial, EtherCAT Master	PM585-MC-KIT	1SAP140500R0379		0.500
2048	0.002 / 0.004 / 0.004	PM590-ETH, CM579-ETHCAT, TB521-ETH, TA524 Ethernet (2), 2 x serial, EtherCAT Master	PM590-MC-KIT	1SAP150000R0379		0.500

(1) Ethernet communication.

(2) Provides integrated web server and IEC 60870-5-104 remote control protocol on each interface independently.

(3) Provides integrated 4 GB flashdisk for user data storage and data logging.

(4) Only to be used with dedicated terminal base TB523-2ETH.



PM572



PM592



PM585-MC-KIT

AC500

Ordering data

AC500 CPU PM595

- 2 Ethernet interfaces with integrated switch and software configurable protocol (PROFINET, EtherCAT or Ethernet e.g. Modbus TCP)
- 2 independent Ethernet interfaces for programming, online access, web server, IEC 60870-5-104 protocol e.g.
- 2 serial interfaces, RS232 / RS485 configurable
- Centrally expandable with up to 10 I/O modules (S500 and/or S500-eCo modules allowed)
- Simultaneous operation of up to 2 external communication modules in any desired combination, no need of additional terminal base

Program memory MB	Cycle time in μ s per instruction min. Bit/Word/Float. point	Integrated communication	Type	Order code	Price	Weight (1 pce) kg
16	0.0006/0.001/0.001	2 x Ethernet (2 Ports switch), 2 x Ethernet (2), 2 x serial	PM595-4ETH-F (3)	1SAP155500R0279		1.050

(2) Provides integrated web server and IEC 60870-5-104 remote control protocol on each interface independently.

(3) Provides integrated 4 GB flashdisk for user data storage and data logging.



PM595-4ETH-F

AC500

Ordering data

Terminal base

- For mounting and connection of the CPUs and communication modules, not needed for PM595
- 1 to 4 plug-in communication modules
- Connection for communication coupler integrated in the CPU
- I/O interface for direct connection of up to 10 expansion modules
- Fieldbus-neutral FieldBusPlug-Slave interface not for TB523-2ETH
- Connection COM1: 9-pole pluggable terminal block
- Connection COM2: D-Sub 9 (not for TB523-2ETH).

Number of coupler slots	Connection for coupler integrated in the CPU	Type	Order code	Price	Weight (1 pce) kg
1	ARCNET BNC	TB511-ARCNET (2)	1SAP111100R0260		0.215
2	ARCNET BNC	TB521-ARCNET (2)	1SAP112100R0260		0.215
1	Ethernet RJ45	TB511-ETH	1SAP111100R0270		0.215
2	Ethernet RJ45	TB521-ETH	1SAP112100R0270		0.215
2	2x Ethernet RJ45	TB523-2ETH (1)	1SAP112300R0277		0.250
4	Ethernet RJ45	TB541-ETH	1SAP114100R0270		0.215

Note: These TBs are compatible with previous AC500 CPU versions (R01xx) and new ones (R02xx).

(1) Can only be used together the PM591-2ETH.

(2) Can be only used with PM590-ARCNET CPU.



TB511-ETH



TB541-ETH

AC500

Ordering data

AC500 Condition Monitoring CMS

- PLC integrated condition monitoring and fast protection for high frequency signals (vibration, current, voltage, speed/encoder)
- FM502-CMS module needs function module terminal base TF5x1 for direct interfacing to CPU, communication couplers, other I/O
 - for stand-alone or control/safety integrated condition monitoring
- PM592 CPU to be used on same TF5x1 for data storage and signal processing or communication
 - C-code interface for own complex diagnosis algorithms, 4GB Flash disk for raw fingerprints and indicator trending
- FM502-CMS module:
 - 16 fast, precise analog inputs, all synchronously sampled; configurable as IEPE or +-10V
 - individual measurement configuration (start,stop,trigger) per channel
 - per channel up to 50ksamples/s and 24bit ADC resolution, adjustable sampling
 - encoder inputs (5V or 24V) up to 300kHz counter; 12 modes, incl. absolute SSI (1MHz)
 - fast data logging, compact WAV-Files delivered automatically to CPU, incl. synchronized encoder signal if configured
 - analogue values always available for fast protection in I/O image of CPU
- Included in Automation Builder: Configuration, libraries for CMS control and wav file handling, examples
- Available download package: Signal processing library, example programs with simple diagnosis, logging and automated triggering (2)

Number of coupler slots	Description	Type	Order code	Price	Weight (1 pce) kg
n.a.	Function Module for Condition Monitoring Systems, 16AI, 2DI, 2DC, 1x Encoder (A, B, Z)	FM502-CMS	1SAP260400R0001		0.215
0	Function module terminal base for FM502, no coupler slots, 1x ETHERNET, 1x serial, spring terminals, 24VDC	TF501-CMS (1)	1SAP117000R0271		0.350
2	Function module terminal base for FM502, 2x coupler slots, 1x ETHERNET, 1x serial, spring terminals, 24VDC	TF521-CMS (1)	1SAP117200R0271		0.400

(1) Can only be used together with FM502 and PM592-ETH

(2) Download of Package under "Application Examples" at www.abb.com/plc



FM502-CMS



TF501-CMS



TF521-CMS

AC500

Ordering data

AC500 V3 CPUs

- 1x internal serial interface, RS232 / RS485 configurable (ACSII or Modbus RTU Master/Slave)
- 2x independant Ethernet interfaces which can also be used as switch and software configurable protocols like PROFINET IO Controller (2)(3), Ethernet IP Adapter (2)(3), EtherCAT Master (2)(3), IEC60870-5-104 or IEC61850 (3)
- Web server with WebVisu HTML5 and optional Remote Target Visu licensed for use with CP600 without Web interface
- 1x internal CAN interface, with CANopen Master/Slave, CAN 2A/2B and J1939 protocols
- Display and 8 function keys for diagnosis and status
- Centrally expandable with up to 10 I/O modules, 320 I/Os (S500 and/or S500-eCo modules allowed)
- Simultaneous operation of several external communication modules in any desired combination
- To be used exclusively with new TB56xx-2ETH
- Optional SD card for data storage and program backup
- To be used only with Automation Builder 2.x

Program / Data memory MB	Cycle time in μ s per instruction min. Bit/Word/Float. point	Integrated communication	Type	Order code	Price	Weight (1 pce) kg
8	0.020 / 0.020 / 0.120	2 x Ethernet with configurable protocols PROFINET IO Controller (2)(3) / EtherCAT Master (2)(3) or EthernetIP (2)(3), 1 x serial, 1x CAN interface	PM5630-2ETH (1) (4)	1SAP131000R0278		0.135
80	0.010 / 0.010 / 0.010	2 x Ethernet with configurable protocols PROFINET IO Controller (2)(3) / EtherCAT Master (2)(3) or EthernetIP (2)(3), 1 x serial, 1x CAN interface	PM5650-2ETH (1) (4)	1SAP141000R0278		0.135
160	0.002 / 0.002 / 0.002	2 x Ethernet with configurable protocols PROFINET IO Controller (2) / EtherCAT Master (2) or EthernetIP (2)(3), 1 x serial, 1x CAN interface	PM5670-2ETH (1) (4)	1SAP151000R0278		0.135
160 / 8GB	0.002 / 0.002 / 0.002	2 x Ethernet with configurable protocols PROFINET IO Controller (2) / EtherCAT Master (2) or EthernetIP (2)(3), 1 x serial, 1x CAN interface	PM5675-2ETH (1) (4)	1SAP151500R0278		0.150

(1) Ethernet communication provides integrated web server, IEC 60870-5-104 remote control protocol and OPC UA Server on each interface independently.

(2) Availability on demand.

(3) Some communication protocols are licensed see following lines

(4) Only to be used with dedicated terminal base TB56xx-2ETH



PM5630-2ETH



PM5650-2ETH



PM5670-2ETH



PM5675-2ETH

Feature licenses

Some HW or FW features need to be licensed to be used on the new CPU. Which allows:

- more flexibility
- better adaptation to the needs

License Type	CPU runtime license to be used on internal Ethernet interface	Type	Order code	Price
HW	Modbus TCP HA runtime license	PS5601-HA-MTCP	1SAP195400R0101	
HW	IEC 61850 protocol runtime license	PS5602-61850	1SAP195600R0101	
HW	Remote target Visu runtime license for use with CP600	PS5603-RTVISU	1SAP195700R0101	

AC500

Ordering data

AC500 V3 Terminal base

- For mounting and connection of the AC500 V3 CPUs only and communication modules
- 0, 1, 2, 4 or up to 6 (2) plug-in communication modules
- Connection for communication coupler integrated in the CPU
- I/O interface for direct connection of up to 10 expansion modules
- Connection COM1: 9-pole pluggable spring terminal block
- Connection CAN: 2x 5-pole pluggable spring terminal block
- 2x RJ45 Ethernet interfaces with configurable switch functionality

Number of coupler slots	Connection for coupler integrated in the CPU	Type	Order code	Price	Weight (1 pce) kg
0	2x RJ45 for Ethernet, 1x serial COM1 with pluggable spring connector and 1x2x5 poles pluggable spring connector for CAN/CANopen interface	TB5600-2ETH	1SAP110300R0278		0.165
1		TB5610-2ETH	1SAP111300R0278		0.190
2		TB5620-2ETH	1SAP112300R0278		0.215
4		TB5640-2ETH	1SAP114300R0278		0.265
6		TB5660-2ETH (2)	1SAP116300R0278		0.315

2) Availability on demand.



TB5600-2ETH



TB5610-2ETH



TB5620-2ETH



TB5640-2ETH

AC500

Ordering data

Communication modules

Protocol	Connections	Type	Order code	Price	Weight (1 pce) kg
PROFIBUS DP V0/V1 master	D-Sub 9	CM592-DP	1SAP173200R0001		0.115
PROFIBUS DP V0/V1 slave	D-Sub 9	CM582-DP	1SAP172200R0001		0.115
Ethernet (TCP/IP, UDP/IP, Modbus TCP)	2 x RJ45 - integrated switch	CM597-ETH	1SAP173700R0001		0.115
CANopen master	Terminal block 2 x 5 poles spring	CM598-CN	1SAP173800R0001		0.115
CANopen slave	Terminal block 2 x 5 poles spring	CM588-CN	1SAP172800R0001		0.115
PROFINET I/O RT controller	2 x RJ45 - integrated switch	CM579-PNIO	1SAP170901R0101		0.115
PROFINET IO RT device	2 x RJ45 - integrated switch	CM589-PNIO	1SAP172900R0011		0.115
PROFINET IO RT with 4 devices	2 x RJ45 - integrated switch	CM589-PNIO-4	1SAP172900R0111		0.115
EtherCAT master	2 x RJ45	CM579-ETHCAT	1SAP170902R0101		0.115
Serial + co-processor	2 x RS-232/485 on spring terminal blocks	CM574-RS	1SAP170400R0201		0.115
Serial RCOM	2 x RS-232/485 (1 x RCOM/1 x Console)	CM574-RCOM	1SAP170401R0201		0.115



CM592-DP

CM574-RS
CM574-RCOM

CM598-CN



CM579-PNIO

I/O modules

- For central expansion of the AC500 or AC500-eCo CPUs
- For decentralized expansion in combination with communication interface modules on CS31, PROFINET IO, EtherCAT, Modbus TCP, PROFIBUS DP, CANopen modules
- DC: Channels can be configured individually as inputs or outputs
- Plug-in electronic modules, terminal unit required (refer to table below).

Digital I/O

Number of	Input signal	Output type	Output signal	Terminal units Screw / Spring	Type	Order code	Price	Weight (1 pce) kg
DI/DO/DC								
32 / - / -	24 V DC	-	-	TU515 / TU516	DI524	1SAP240000R0001		0.200
- / - / 16	24 V DC	Transistor	24 V DC, 0.5 A	TU515 / TU516	DC522	1SAP240600R0001		0.200
- / - / 24	24 V DC	Transistor	24 V DC, 0.5 A	TU515 / TU516	DC523	1SAP240500R0001		0.200
16 / - / 16	24 V DC	Transistor	24 V DC, 0.5 A	TU515 / TU516	DC532	1SAP240100R0001		0.200
8 / 8 / -	24 V DC	Relay	230 V AC, 3 A (2)	TU531 / TU532	DX522	1SAP245200R0001		0.300
8 / 4 / -	230 V AC	Relay	230 V AC, 3 A (2)	TU531 / TU532	DX531	1SAP245000R0001		0.300
- / 32 / -	24 V DC	Transistor	24 V DC, 0.5 A	TU515 / TU516	DO524	1SAP240700R0001		0.200
- / 8 / -	-	Transistor	24 V DC, 2 A	-- / TU542	DO526	1SAP240800R0001		0.200

(2) Relay outputs, changeover contacts.



DO524

AC500

Ordering data

Analog I/O

Number of	Input signal	Output signal	Terminal units Screw / Spring	Type	Order code	Price	Weight (1 pce) kg
AI/AO							
16 / 0	0...10 V, ±10 V	–	TU515 / TU516	AI523	1SAP250300R0001		0.200
4 / 4	0/4...20 mA, PT100, PT1000, Ni1000	±10 V	TU515 / TU516	AX521	1SAP250100R0001		0.200
8 / 8 (max. 4 current outputs)		0/4...20 mA	TU515 / TU516	AX522	1SAP250000R0001		0.200
0 / 16 (max. 8 current outputs)	–		TU515 / TU516	AO523	1SAP250200R0001		0.200
8 / 0	0...5 V, 0...10 V, ±50 mV, ±500 mV, 1 V, ±5 V, ±10 V, 0/4...20 mA, ±20 mA, PT100, PT1000, Ni1000, Cu50, 0...50 kΩ, S, T, N, K, J	–	TU515 / TU516	AI531	1SAP250600R0001		0.200

Analog/digital mixed I/O

Standard I/O module with high functionality:

- 16 digital input channels
- 8 configurable In/Output channels
- first two inputs are also usable as high-speed counter (up to 50 kHz) together with AC500 CPU, CS31 or CI5xx communication interface modules.
- 4 independent analog input channels configurable for voltage, current, 12 bit + sign, 1-2 wire connection
- Galvanic isolation per module
- Compatible with all CI5xx modules.

Number of	Input signal	Output type	Output signal	Terminal unit Screw / Spring	Type	Order code	Price	Weight (1 pce) kg
AI/AO/DI/DO/DC								
4 / 2 / 16 / - / 8	24 V DC/0...10 V, -10...+10 V, 0...20 mA, 4...20 mA, PT100, PT1000, Ni100, Ni1000	Transistor	24 V DC, 0.5 A / -10...+10 V, 0...20 mA, 4...20 mA	TU515 / TU516	DA501	1SAP250700R0001		0.200

Multifunctional modules

Functionality	Number of	Input signal	Output type	Output signal	Terminal units Screw / Spring	Type	Order code	Price	Weight (1 pce) kg
DI/DO/DC									
Encoder module									
Encoder and PWM module	2 / - / 8	24 V DC and 2 encoder inputs A/B/C differential	2 PWM outputs	24 V DC, 0.1 A	TU515 / TU516	CD522	1SAP260300R0001		0.125

- DC541 occupies one communication module slot on the AC500 CPU terminal base, no terminal block required
- Usable with all CI5xx modules.

Functionality	Number of	Input signal	Output type	Output signal	Terminal unit	Type	Order code	Price	Weight (1 pce) kg
DI/DO/DC									
Interrupt I/O and fast counter module									
Interrupt I/O and fast counter	- / - / 8	24 V DC	Transistor	24 V DC, 0.5 A	N/A (2)	DC541-CM (1)	1SAP270000R0001		0.100

(1) Multifunctional module, refer to table on page 100 for details.

(2) Occupies a communication module slot.



AI523



AI531



AX521



AO523

AC500

Ordering data

Communication interface modules

Number of AI/AO/DI/DO/DC	Input signal	Output type	Output signal	Terminal units Screw / Spring	Type	Order code	Price	Weight (1 pce) kg
For CS31-Bus								
- / - / 8 / - / 16	24 V DC	Transistor	24 V DC, 0.5 A	TU551-CS31 / TU552-CS31	DC551-CS31	1SAP220500R0001		0.200
- / - / - / - / 16	24 V DC	Transistor	24 V DC, 0.5 A	TU551-CS31 / TU552-CS31	CI590-CS31-HA	1SAP221100R0001		0.200
4 / 2 / 8 / - / 8	24 V DC/ 0...10 V, -10...+10 V, 0...20 mA, 4...20 mA, PT100, PT1000, Ni100, Ni1000	Transistor	24 V DC, 0.5 A/ -10...+10 V, 0...20 mA, 4...20 mA	TU551-CS31 / TU552-CS31	CI592-CS31	1SAP221200R0001		0.200
For PROFIBUS-DP								
4 / 2 / 8 / 8 / -	24 V DC/ 0...10 V, -10...+10 V, 0...20 mA, 4...20 mA, PT100, PT1000, Ni100, Ni1000	Transistor	24 V DC, 0.5 A/ -10...+10 V, 0...20 mA, 4...20 mA (1)	TU509/TU510/ TU517/TU518	CI541-DP	1SAP224100R0001		0.200
- / - / 8 / 8 / 8	24 V DC	Transistor	24 V DC, 0.5 A	TU509/TU510/ TU517/TU518	CI542-DP	1SAP224200R0001		0.200
For CANopen								
4 / 2 / 8 / 8 / -	24 V DC/ 0...10 V, -10...+10 V, 0...20 mA, 4...20 mA, PT100, PT1000, Ni100, Ni1000	Transistor	24 V DC, 0.5 A/ -10...+10 V, 0...20 mA, 4...20 mA	TU509/TU510/ TU517/TU518	CI581-CN	1SAP228100R0001		0.200
- / - / 8 / 8 / 8	24 V DC	Transistor	24 V DC, 0.5 A	TU509/TU510/ TU517/TU518	CI582-CN	1SAP228200R0001		0.200
For Ethernet based protocol - EtherCAT								
4 / 2 / 8 / 8 / -	24 V DC/ 0...10 V, -10...+10 V, 0...20 mA, 4...20 mA, PT100, PT1000, Ni100, Ni1000	Transistor	24 V DC, 0.5 A/ -10...+10 V, 0...20 mA, 4...20 mA	TU507-ETH / TU508-ETH	CI511-ETHCAT	1SAP220900R0001		0.200
- / - / 8 / 8 / 8	24 V DC	Transistor	24 V DC, 0.5 A	TU507-ETH / TU508-ETH	CI512-ETHCAT	1SAP221000R0001		0.200
For Ethernet based protocol - PROFINET IO RT								
4/2/8/8/-	24 V DC/ 0...10 V, -10...+10 V, 0...20 mA, 4...20 mA, PT100, PT1000, Ni100, Ni1000	Transistor	24 V DC, 0.5 A/ -10...+10 V, 0...20 mA, 4...20 mA	TU507-ETH / TU508-ETH	CI501-PNIO	1SAP220600R0001		0.200
- / - / 8 / 8 / 8	24 V DC	Transistor	24 V DC, 0.5 A	TU507-ETH / TU508-ETH	CI502-PNIO	1SAP220700R0001		0.200
For Ethernet based protocol - Modbus TCP								
4/2/8/8/-	24 V DC/ 0...10 V, -10...+10 V, 0...20 mA, 4...20 mA, PT100, PT1000, Ni100, Ni1000	Transistor	24 V DC, 0.5 A/ -10...+10 V, 0...20 mA, 4...20 mA	TU507-ETH / TU508-ETH	CI521-MODTCP	1SAP222100R0001		0.200
- / - / 8 / 8 / 8	24 V DC	Transistor	24 V DC, 0.5 A	TU507-ETH / TU508-ETH	CI522-MODTCP	1SAP222200R0001		0.200



CI541-DP



CI581-CN



CI511-ETHCAT



CI501-PNIO

AC500

Ordering data

Communication interface modules

From	To	Output signal	Terminal units	Type	Order code	Price	Weight (1 pce) kg
Gateway on Ethernet based protocol - PROFINET IO RT							
PROFINET I/O	–	3 x RS232/485 ASCII serial interfaces	TU520-ETH	CI504-PNIO	1SAP221300R0001		0.200
PROFINET I/O	1x CAN 2A/2B or CANopen Master	2 x RS232/485 ASCII serial interfaces	TU520-ETH	CI506-PNIO	1SAP221500R0001		0.200



CI504-PNIO

Terminal units

For digital and analog expansion modules and interface modules. Please note: for modules with relay outputs, terminal units for 230 V AC (TU531 / TU532) are required.

For	Supply	Connection type	Type	Order code	Price	Weight (1 pce) kg
Ethernet communication interface modules	24 V DC	Screw	TU507-ETH	1SAP214200R0001		0.300
		Spring	TU508-ETH	1SAP214000R0001		0.300
Ethernet gateway modules	24 V DC	Spring	TU520-ETH	1SAP214400R0001		0.300
CANopen / PROFIBUS DP (1) communication interface modules	24 V DC	Screw	TU517	1SAP211400R0001		0.300
		Spring	TU518	1SAP211200R0001		0.300
PROFIBUS DP / CANopen communication interface modules	24 V DC	Screw	TU509	1SAP211000R0001		0.300
		Spring	TU510	1SAP210800R0001		0.300
I/O modules	24 V DC	Screw	TU515	1SAP212200R0001		0.300
		Spring	TU516	1SAP212000R0001		0.300
I/O modules - for Hot Swap (2)	24 V DC	Spring	TU516-H	1SAP215000R0001		0.300
I/O modules AC / relay	230 V AC	Screw	TU531	1SAP217200R0001		0.300
		Spring	TU532	1SAP217000R0001		0.300
I/O modules AC / relay - for Hot Swap (2)	230 V AC	Spring	TU532-H	1SAP215100R0001		0.300
I/O module DO526	24 V DC	Spring	TU542	1SAP213200R0001		0.300
I/O module DO526 - for Hot Swap (2)	24 V DC	Spring	TU542-H	1SAP215200R0001		0.300
CS31 interface modules	24 V DC	Screw	TU551-CS31	1SAP210600R0001		0.300
		Spring	TU552-CS31	1SAP210400R0001		0.300

(1) TU517/TU518 Terminal units can also be used with PROFIBUS DP CI54x modules up to 1 Mbaud.

(2) in preparation



TU515



TU520-ETH



TU510



TU518



TU508-ETH

AC500

Ordering data

Terminal units compatibility

Type	For I/O modules			For communication interface modules				
	TU515	TU542	TU531	TU507-ETH	TU509	TU517	TU520-ETH	TU551-CS31
	TU516 TU516-H	TU542-H	TU532 TU532-H	TU508-ETH	TU510	TU518		TU552-CS31
DA501	•							
DC522	•							
DC523	•							
DC532	•							
DI524	•							
DX522			•					
DX531			•					
DO524	•							
DO526		•						
CD522	•							
AI523	•							
AI531	•							
AO523	•							
AX521	•							
AX522	•							
DC551-CS31								•
CI590-CS31-HA								•
CI592-CS31								•
CI501-PNIO				•				
CI502-PNIO				•				
CI504-PNIO							•	
CI506-PNIO							•	
CI511-ETHCAT				•				
CI512-ETHCAT				•				
CI521-MODTCP				•				
CI522-MODTCP				•				
CI541-DP					•			• (1)
CI542-DP					•			• (1)
CI581-CN					•			•
CI582-CN					•			•

(1) Can be used with baud rate up to 1 Mbaud.

AC500

Ordering data

Accessories for AC500

For	Description	Type	Order code	Price	Weight (1 pce) kg
AC500 CPUs COM1	Programming cable Sub-D / terminal block, length 5 m	TK502	1SAP180200R0101		0.400
AC500 CPUs COM2	Programming cable Sub-D / Sub-D, length 5 m	TK501	1SAP180200R0001		0.400
AC500 CPUs	Memory card (2 GB SD card)	MC502	1SAP180100R0001		0.020
	Lithium battery for data buffering	TA521	1SAP180300R0001		0.100
I/O modules	Pluggable marker holder for I/O modules, packing unit incl. 10 pcs. Template available in the AC500 online help	TA523	1SAP180500R0001		0.300
AC500 CPU's, interface module, communication module and I/O modules	White labels, packaging unit incl.10 pcs.	TA525	1SAP180700R0001		0.100
Terminal base	Communication Module, blind cap	TA524	1SAP180600R0001		0.120
CPU terminal base	Accessories for wall mounting, packing unit includes 10 pcs	TA526	1SAP180800R0001		0.200
	5-pole power plug for AC500. Spare part. Can be plugged to CPU terminal base TB5x1. Packing unit includes 5 pcs	TA527	1SAP181100R0001		0.200
	9-pole COM1 plug for AC500. Spare part. Can be plugged to CPU terminal base TB5x1 or on TU520-ETH. Packing unit includes 5 pcs	TA528	1SAP181200R0001		0.200
Communication modules	9-pole spring plug for CM574-RS/RCOM. Spare part. Packing includes 10 pcs	TA532	1SAP182000R0001		
	5-pole spring plug for CM575-DN/CM578-CN. Spare part. Packing includes 5 pcs	TA533	1SAP182100R0001		
	2x5-pole spring plug for CM588-CN and CM598-CN. Spare part. Packing includes 5 pcs.	TA534	1SAP182200R0001		
	10-pole spring plug for DC541-CM. Spare part. Packing includes 10 pcs.	TA536	1SAP183100R0001		
AC500 basic training case CPU, I/Os, HMI	PM583-ETH + MC502 + CM572-DP + AX561 + DC551-CS31 + CI542-DP + CP635 + power supply + Ethernet cables + simulation stand	TA512-BAS	1SAP182400R0001		7.000
AC500 advanced training case CPU, I/Os, COM, encoder	PM583-ETH + MC502 + CM579-PNIO + CM579-ETHCAT + CM574-RS + CM578-CN + CD522 + CI501-PNIO + CI512-ETHCAT + CI582-CN + power supply + cables + simulation stand	TA513-ADV	1SAP182500R0001		8.800
AC500 CPUs PM595	Protective cap, spare-parts, 3 pieces	TA540	1SAP182600R0001		0.200
	Lithium battery for real-time-clock buffering	TA541	1SAP182700R0001		0.030
	Accessories for screw-mounting, 20 pieces	TA543	1SAP182800R0001		0.100



MC502

AC500 basic training case
CPU, I/Os, HMI

AC500

Technical data

AC500 CPUs

Type	PM572	PM573-ETH	PM582	PM583-ETH	PM585-ETH
Supply voltage	24 V DC				
Current consumption on 24 V DC					
Min. (module alone)	0.050 A	0.110 A	0.050 A	0.110 A	0.150 A
Max. (all couplers and I/Os)	0.750 A	0.810 A	0.750 A	0.810 A	0.850 A
User program memory – Flash EPROM and RAM	128 kB	512 kB	512 kB	1024 kB	1024 kB
Integrated user data memory	128 kB thereof 12 kB saved	512 kB thereof 288 kB saved	416 kB thereof 288 kB saved	1024 kB thereof 288 kB saved	2560 kB thereof 1536 kB saved
User Flashdisk (Data-storage, programm access or also external with FTP)	–				
Plug-in memory card	Depending on SD-Card used : no SD-HC card allowed, use MC502 accessory				
Web server's data for user RAM disk	–	1 024 kB	–	4 096 kB	4 096 kB
Cycle time for 1 instruction (minimum)					
Binary	0.06 µs	0.06 µs	0.05 µs	0.05 µs	0.004 µs
Word	0.09 µs	0.09 µs	0.06 µs	0.06 µs	0.008 µs
Floating-point	0.7 µs	0.7 µs	0.5 µs	0.5 µs	0.008 µs
Max. number of centralized inputs/outputs					
Max. number of extension modules on I/O bus	up to max. 10 (S500 and/or S500-eCo modules allowed)				
Digital inputs/outputs	320/320				
Analog inputs/outputs	160/160				
Max. number of decentralized inputs/outputs	depends on the used standard Fieldbus (1)				
Data buffering	battery				
Real-time clock (with battery back-up)	●				
Program execution					
Cyclical / Time controlled / Multi tasking	●/●/●				
User program protection by password	●				
Internal interfaces					
COM1					
RS232 / RS485 configurable	●				
Connection (on terminal bases or CPU module)	pluggable spring terminal block, use TK502 cable in accessory				
Programming, Modbus RTU, ASCII, CS31 master	●				
COM2					
RS232 / RS485 configurable	●				
Connection (on terminal bases or CPU module)	D-Sub 9 female, use TK501 cable in accessory				
Programming, Modbus RTU, ASCII	●				
FieldBusPlug					
Serial neutral interface	●				
Connection (on terminal bases)	M12 male, 5 pole				
Functions	programming cable UTF-21-FBP, slave communication depending on FieldBusPlug used (PROFIBUS DP, CANopen, DeviceNet)				
Ethernet					
Ethernet connection (on terminal bases)	–	RJ45	–	RJ45	RJ45
Ethernet functions: Programming, TCP/IP, UDP/IP, Modbus TCP, integrated Web server, IEC60870-5-104 remote control protocol, SNTP (simple Network Time Protocol), DHCP, FTP server HTTP, SMTP, PING	–	●	–	●	●
Ethernet based Fieldbus					
Ethernet connection (on CPU module)	–				
Downloadable protocols like: PROFINET IO RT Controller / Device (2) EtherCAT Master	–				
LCD display	LCD display and 8 function keys				
Function	RUN / STOP, status, diagnosis				
LEDs for various status display	–				
Timer/Counter	unlimited/unlimited				
Approvals	See detailed page 220 or www.abb.com/plc				

(1) e.g. CS31 Fieldbus: up to 31 stations with up to 120 DIs / 120 DOs or up to 32 AIs / 32 AOs per station.

(2) Availability on demand

AC500

Technical data

AC500 CPUs

Type	PM590-ETH	PM591-ETH	PM591-2ETH	PM592-ETH	PM595-4ETH-F
Supply voltage	24 V DC				
Current consumption on 24 V DC					
Min. (module alone)	0.150 A	0.150 A	0.150 A	0.150 A	0.400 A
Max. (all couplers and I/Os)	0.850 A	0.850 A	0.850 A	0.850 A	1.2 A
User program memory – Flash EPROM and RAM	2048 kB	4096 kB	4096 kB	4096 kB	16384 kB
Integrated user data memory	3072 kB thereof 1536 kB saved	5632 kB thereof 1536 kB saved	5632 kB thereof 1536 kB saved	5632 kB thereof 1536 kB saved	16384 kB thereof 3072 kB saved
User Flashdisk (Data-storage, programm access or also external with FTP)	-			Yes, 4 GB Flash non removable	
Plug-in memory card	Depending on SD-Card used : no SD-HC card allowed, use MC502 accessory				
Web server's data for user RAM disk	8 MB				32 MB
Cycle time for 1 instruction (minimum)					
Binary	0.002 µs	0.002 µs	0.002 µs	0.002 µs	0.0006 µs
Word	0.004 µs	0.004 µs	0.004 µs	0.004 µs	0.001 µs
Floating-point	0.004 µs	0.004 µs	0.004 µs	0.004 µs	0.001 µs
Max. number of centralized inputs/outputs					
Max. number of extension modules on I/O bus	up to max. 10 (S500 and/or S500-eCo modules allowed)				
Digital	inputs/outputs 320/320				
Analog	inputs/outputs 160/160				
Max. number of decentralized inputs/outputs					
depends on the used standard Fieldbus (1)					
Data buffering	battery				
Real-time clock (with battery back-up)	●				
Program execution					
Cyclical / Time controlled / Multi tasking	●/●/●				
User program protection by password	●				
Internal interfaces					
COM1					
RS232 / RS485 configurable	●				
Connection (on terminal bases or CPU module)	pluggable spring terminal block, use TK502 cable in accessory				
Programming, Modbus RTU, ASCII, CS31 master	●				
COM2					
RS232 / RS485 configurable	●				
Connection (on terminal bases or CPU module)	D-Sub 9 female, use TK501 cable in accessory				
Programming, Modbus RTU, ASCII	●				
FieldBusPlug					
Serial neutral interface	●				-
Connection (on terminal bases)	M12 male, 5 pole				-
Functions	programming cable UTF-21-FBP, slave communication depending on FieldBusPlug used (PROFIBUS DP, CANopen, DeviceNet)				-
Ethernet					
Ethernet connection (on terminal bases)	RJ45	RJ45	2 x RJ45	RJ45	2 x RJ45
Ethernet functions: Programming, TCP/IP, UDP/IP, Modbus TCP, integrated Web server, IEC60870-5-104 remote control protocol, SNTP (simple Network Time Protocol), DHCP, FTP server HTTP, SMTP, PING	●	●	●	●	●
Ethernet based Fieldbus					
Ethernet connection (on CPU module)	-				4 x RJ45 (2 x interfaces with 2-port switch)
Downloadable protocols like: PROFINET IO RT Controller / EtherCAT Master or Ethernet like ModbusTCP	-				●
LCD display					
Function	LCD display and 8 function keys				RUN / STOP, status, diagnosis, RESET
LEDs for various status display	-				●
Timer/Counter	unlimited/unlimited				
Approvals					
See detailed page 220 or www.abb.com/plc					

(1) e.g. CS31 Fieldbus: up to 31 stations with up to 120 DI / 120 DO or up to 32 AI / 32 AO per station.

(2) Availability on demand

AC500

Technical data

AC500 V3 CPUs

Type	PM5630-2ETH	PM5650-2ETH	PM5670-2ETH	PM5675-2ETH
Supply voltage	24 V DC			
Current consumption on 24 V DC				
Min. typ. (module alone)	0.150 A	0.200 A	0.250 A	0.250 A
Max. typ. (all couplers and I/Os)	0.850 A	0.900 A	0.950 A	0.950 A
User program memory / User Data memory	8 MB	80 MB	160 MB	160 MB
Web server's data – Flash EPROM and DRAM				
User data memory saved	256 KB	256 KB	1.5 MB	1.5 MB
User Flashdisk (Data-storage, programm access or also external with FTP)				8 GB Flash non removable
Plug-in memory card	Depending on SD-Card used : SD-HC card allowed, use MC502 preferably accessory			
Web server's data for user RAM disk	8 MB	No limitation, included into the global User Program/Data memory		
Cycle time for 1 instruction (minimum)				
Binary	0.02 µs	0.01 µs	0.002 µs	0.002 µs
Word	0.03 µs	0.01 µs	0.002 µs	0.002 µs
Floating-point	0.12 µs	0.01 µs	0.002 µs	0.002 µs
Communication modules supported				
Max. number of communication modules on TBs	up to 2	Up to 6 depending on available terminal bases (2)		
Type of communication module supported	CM579-PNIO, CM589-PNIO, CM579-ETHCAT, CM582-DP (2), CM592-DP (2) , CM597-ETH (2) and CM598-CN (2)			
Max. number of centralized inputs/outputs				
Max. number of extension modules on I/O bus	up to max. 10 (S500 and/or S500-eCo modules allowed)			
Digital	inputs/outputs	320/320		
Analog	inputs/outputs	160/160		
Max. number of decentralized inputs/outputs				
depends on the used standard Fieldbus (1)				
Data buffering	battery			
Real-time clock (with battery back-up)	●			
Program execution				
Cyclical / Time controlled / multi tasking	●/●/●			
User program protection by password	●			
Internal interfaces				
COM1				
RS232 / RS485 configurable	●			
Connection (on terminal bases or CPU module)	pluggable spring terminal block, use TK502 cable in accessory			
Modbus RTU Master/Slave, ASCII	●			
CANopen				
Serial interface	CAN serial interface			
Connection (on terminal bases)	Pluggable spring terminal block, 2x 5 poles			
Functions	CANopen Master / Slave communication, CAN 2A/2B, J1939 protocol			
Ethernet				
Ethernet connection (on terminal bases)	2x independent Ethernet interfaces for several uses			
Ethernet connection (on terminal bases)	2x RJ45 with 2x separated interfaces and MAC-Address, could be used as 2-port switch with 1x interface			
Ethernet functions:				
Online Access, ICMP (Ping), DHCP	●			
IP configuration protocol	●			
UDP data exchange, Network variables	●			
Modbus TCP Client / Server	●			
IEC60870-5-104 remote control protocol	●			
HTTP / HTTPs (integrated Web server)	●			
SNTP (Time synchronization)	●			
FTP / FTPs server	●			
SMTP client	●			
Socket programming	●			
WebVisu for data visualisation on webserver HTML5	●			
OPC UA Server (Micro Embedded Device Server) with security	●			
Ethernet Switch on ETH1 / ETH2	●			

(1) e.g. CANopen Fieldbus: up to 127 stations with up to 320 Digital channels or up to 160 Analog channels per station.

(2) Availability on demand

(3) Feature is licensed

AC500

Technical data

AC500 V3 CPUs

Type	PM5630-2ETH	PM5650-2ETH	PM5670-2ETH	PM5675-2ETH
Ethernet based Fieldbus				
Downloadable protocols (licensed feature):	available on one Ethernet interface, the other interface can be sometimes used as switch			
IEC 61850 server	● (3)	● (3)	● (3)	● (3)
PROFINET IO RT Controller	● (2)(3)	● (2)(3)	● (2)	● (2)
EtherCAT Master	● (2)(3)	● (2)(3)	● (2)	● (2)
EthernetIP Adapter	● (2)(3)	● (2)(3)	● (2)(3)	● (2)(3)
LCD display	LCD display and 8 function keys			
Function	RUN / STOP, status, diagnosis			
LEDs for various status display	●			
Timer/Counter	unlimited/unlimited			
Approvals	See detailed page 220 or www.abb.com/plc			

(1) e.g. CANopen Fieldbus: up to 127 stations with up to 320 Digital channels or up to 160 Analog channels per station.

(2) Availability on demand

(3) Feature is licensed

AC500

Technical data

Digital S500 I/O modules

Type	DI524	DC522	DC523	DC532
Number of channels per module				
Digital				
inputs	32	–	–	16
outputs	–	–	–	–
Configurable channels DC (configurable as inputs or outputs)	–	16	24	16
Additional configuration of channels as				
Fast counter	configuration of max. 2 channels per module, operating modes see table on page 116			
Occupies max. 1 DO or DC when used as counter	–	●	●	●
Connection via terminal unit	●	●	●	●
Digital inputs				
Input signal voltage	24 V DC			
Input characteristic acc. to EN 61132-2	Type 1			
0 signal	-3...+5 V DC			
Undefined signal state	5...15 V DC			
1 signal	15...30 V DC			
Input time delay (0 -> 1 or 1 -> 0)	8 ms typically, configurable from 0.1 up to 32 ms			
Input current per channel				
At input voltage	24 V DC 5 mA typically			
	5 V DC > 1 mA			
	15 V DC > 5 mA			
	30 V DC < 8 mA			
Digital outputs				
Transistor outputs 24 V DC, 0.5 A	–	●	●	●
Readback of output	–	●	●	●
Switching of load 24 V	–	●	●	●
Output voltage at signal state 1	–	process voltage UP minus 0.8 V		
Output current				
Nominal current per channel	–	500 mA at UP = 24 V		
Maximum (total current of all channels)	–	8 A		
Residual current at signal state 0	–	< 0.5 mA		
Demagnetization when switching off inductive loads	–	by internal varistors		
Switching frequency				
For inductive load	–	0.5 Hz max.		
For lamp load	–	11 Hz max. at max. 5 W		
Short-circuit / overload proofness	–	●	●	●
Overload indication (I > 0.7 A)	–	after approx. 100 ms		
Output current limiting	–	yes, with automatic reclosure		
Proofness against reverse feeding of 24 V signals	–	●	●	●
Process voltage UP				
Nominal voltage	24 V DC			
Current consumption on UP				
Min. (module alone)	0.150 A	0.100 A	0.150 A	
Max. (min. + loads)	0.150 A	0.100 A + load	0.150 A + load	
Reverse polarity protection	●	●	●	●
Fuse for process voltage UP	10 A miniature fuse			
Connections for sensor voltage supply. Terminal 24 V and 0 V for each connection. Permitted load for each group of 4 or 8 connections: 0.5 A	–	8	4	–
Short-circuit and overload proof 24 VDC sensor supply voltage	–	●	●	–
Maximum cable length for connected process signals				
Cable	shielded	1000 m		
	unshielded	600 m		
Potential isolation				
Per module		●	●	●
Between channels	input	–	–	–
	output	–	–	–
Voltage supply for the module	internally via extension bus interface (I/O bus)			
Fieldbus connection	via AC500 CPU or all communication interface modules			
Address setting	automatically (internal)			

AC500

Technical data

Digital S500 I/O modules

Type		DX522	DX531	DO524	DO526	
Number of channels per module						
Digital	inputs	8	8	–	–	
	outputs	8 relays	4 relays	32	8	
Configurable channels DC (configurable as inputs or outputs)		–	–	–	–	
Additional configuration of channels as						
Fast counter		configuration of max. 2 channels per module, operating modes see page 116	–	–	–	
Occupies max. 1 DO or DC when used as counter		–	–	–	–	
Connection via terminal unit		●	●	●	●	
Digital inputs						
Input signal voltage		24 V DC	230 V AC or 120 V AC	–	–	
Frequency range		–	47...63 Hz	–	–	
Input characteristic acc. to EN 61132-2		Type 1	Type 2	–	–	
0 signal		-3...+5 V DC	0...40 V AC	–	–	
Undefined signal state		5...15 V DC	> 40 V AC...< 74 V AC	–	–	
1 signal		15...30 V DC	74...265 V AC	–	–	
Input time delay (0 -> 1 or 1 -> 0)		8 ms typically, configurable from 0.1 up to 32 ms	20 ms typically	–	–	
Input current per channel						
At input voltage		24 V DC	5 mA typically	–	–	
		5 V DC	> 1 mA	–	–	
		15 V DC	> 5 mA	–	–	
		30 V DC	< 8 mA	–	–	
		159 V AC	–	> 7 mA	–	–
		40 V AC	–	< 5 mA	–	–
Digital outputs						
Transistor outputs 24 V DC		–	–	●	●	
Readback output		–	–	–	–	
Relay outputs, supplied via process voltage UP, changeover contacts		●	●	–	–	
Switching of load		24 V	●	●	●	
		230 V	●	●	–	
Output voltage at signal state 1		–	–	process voltage UP minus 0.8 V	process voltage UP minus 0.4 V	
Output current						
Nominal current per channel		–	–	500 mA at UP = 24 V	2 A at UP = 24 V	
Maximum (total current of all channels)		–	–	8 A	16 A	
Residual current at signal state 0		–	–	< 0.5 mA	< 0.1 mA	
Demagnetization when switching off inductive loads		–	–	by internal varistors	by internal clamping diode	
Switching frequency						
For inductive load		2 Hz		0.5 Hz max.	2 Hz max.	
For lamp load		11 Hz max. at max. 5 W			11 Hz max. 48 W	
Short-circuit / overload proofness		by external fuse / circuit breaker. 6 A gL/gG per channel		●	by external fuse 10A fast	
Overload indication (I > 0.7 A)		–	–	after approx. 100 ms	–	
Output current limiting		–	–	yes, with automatic reclosure	–	
Proofness against reverse feeding of 24 V signals		–	–	●	●	

AC500

Technical data

Digital S500 I/O modules

Type	DX522	DX531	DO524	DO526
Contact rating				
For resistive load, max.	3 A at 230 V AC 2 A at 24 V DC		–	
For inductive load, max.	1.5 A at 230 V AC 1.5 A at 24 V DC		–	
For lamp load	60 W at 230 V AC 10 W at 24 V DC		–	
Lifetime (switching cycles)				
Mechanical lifetime	300 000		–	–
Lifetime under load	300 000 at 24 V DC / 2 A 200 000 at 120 V AC / 2 A 100 000 at 230 V AC / 3 A		–	–
Spark suppression for inductive AC load	external measure depending on the switched load		–	–
Demagnetization for inductive DC load	external measure: free-wheeling diode connected in parallel to the load		–	–
Process voltage UP				
Nominal voltage	24 V DC			
Current consumption on UP				
Min. (module alone)	0.050 A	0.150 A	0.050 A	0.050 A
Max. (module + loads)	0.050 A + load	0.150 A + load	0.100 A + load	0.100 A + load
Reverse polarity protection	●	●	●	●
Fuse for process voltage UP	10 A miniature fuse			
Maximum cable length for connected process signals				
Cable	shielded	1000 m		
	unshielded	600 m		
Potential isolation				
Per module	●	●	●	●
Between the channels	input	–	● (per 2)	–
	output	●	●	–
Voltage supply for the module	internally via extension bus interface (I/O bus)			
Fieldbus connection	via AC500 CPU or all communication interface modules			
Address setting	automatically (internal)			

AC500

Technical data

Analog S500 I/O modules

Type		AX521	AX522	AI523	AO523	AI531
Number of channels per module						
Individual configuration, analog	inputs	4	8	16	–	8
	outputs	4	8	–	16	–
Signal resolution for channel configuration						
-10...+10 V		12 bits + sign				15 bits + sign
0...10 V		12 bits				15 bits
0...20 mA, 4...20 mA		12 bits				15 bits
Temperature: 0.1 °C		•	•	•	–	•
Monitoring configuration per channel						
Plausibility monitoring		•	•	•	•	•
Wire break & short-circuit monitoring		•	•	•	•	•
Analog Inputs AI						
Signal configuration per AI		max. number per module and with regard to the configuration: AIs / Measuring points (depending on the use of 2/3-wire connection or differential input)				
-50...+50 mV, -500...+500 mV, -1...+1 V, -5...+5 V, 0...+5 V		–	–	–	–	8 / 8
0...10 V		4 / 4	8 / 8	16 / 16	–	8 / 8
-10...+10 V		4 / 4	8 / 8	16 / 16	–	8 / 8
0...20 mA		4 / 4	8 / 8	16 / 16	–	8 / 8
4...20 mA		4 / 4	8 / 8	16 / 16	–	8 / 8
-20...+20 mA		–	–	–	–	8 / 8
Pt100						
-50...+400 °C (2-wire)		4 / 4	8 / 8	16 / 16	–	8 / 8
-50...+400 °C (3-wire), 2 channels		4 / 2	8 / 4	16 / 8	–	8 / 8
-50...+400 °C (4-wire)		–	–	–	–	8 / 8
-50...+70 °C (2-wire)		4 / 4	8 / 8	16 / 16	–	8 / 8
-50...+70 °C (3-wire), 2 channels		4 / 2	8 / 4	16 / 8	–	8 / 8
-50...+70 °C (4-wire)		–	–	–	–	8 / 8
Pt1000						
-50...+400 °C (2-wire)		4 / 4	8 / 8	16 / 16	–	8 / 8
-50...+400 °C (3-wire), 2 channels		4 / 2	8 / 4	16 / 8	–	8 / 8
-50...+400 °C (4-wire)		–	–	–	–	8 / 8
Ni1000						
-50...+150 °C (2-wire)		4 / 4	8 / 8	16 / 16	–	8 / 8
-50...+150 °C (3-wire), 2 channels		4 / 2	8 / 4	16 / 8	–	8 / 8
-50...+150 °C (4-wire)		–	–	–	–	8 / 8
Cu50 -200...+200 °C		–	–	–	–	8 / 8
Resistor		–	–	–	–	8 / 8
Thermocouples of types J, K, T, N, S		–	–	–	–	•
0...10 V using differential inputs, 2 channels		4 / 2	8 / 4	16 / 8	–	8 / 8
-10...+10 V using differential inputs, 2 channels		4 / 2	8 / 4	16 / 8	–	8 / 8
Digital signals (digital input)		4 / 4	8 / 8	16 / 16	–	8 / 8
Input resistance per channel		voltage: > 100 kΩ current: approx. 330 Ω			–	voltage: > 100 kΩ current: approx. 330 Ω
Time constant of the input filter		voltage: 100 μs current: 100 μs			–	voltage: 100 μs current: 100 μs
Conversion cycle		2 ms (for 8 AI + 8 AO), 1 s for Pt100/1000, Ni1000			–	1 ms (for 8 AI + 8 AO), 1 s for Pt100/1000, Ni1000
Overvoltage protection		•	•	•	–	•

(1) Half can be used on current (the other half remains available).

AC500

Technical data

Analog S500 I/O modules

Type		AX521	AX522	AI523	AO523	AI531
Data when using the AI as digital input						
Input	time delay	8 ms typically, configurable from 0.1 up to 32 ms			–	8 ms typically, configurable from 0.1 up to 32 ms
	signal voltage	24 V DC			–	24 V DC
Signal	0	-30...+5 V			–	-30...+5 V
	1	13...30 V			–	13...30 V
Analog outputs AO						
Possible configuration per AO		Max. number of AOs per module and with regard to the configuration:				
	-10...+10 V	4	8 (1)	–	16 (1)	–
	0...20 mA	4	–	–	8	–
	4...20 mA	4	–	–	8	–
Output	resistance (burden) when used as current output	0...500 Ω			–	0...500 Ω
	loading capability when used as voltage output	Max. ±10 mA			–	Max. ±10 mA
Process voltage UP						
Nominal voltage		24 V DC				
Current consumption on UP						
	Min. (module alone)	0.150 A				0.130 A
	Max. (min. + loads)	0.150 A + load	0.150 A + load	–	0.150 A + load	–
Reverse polarity protection		●	●	●	●	●
Max. line length of the analog lines, conductor cross section > 0.14 mm ²		100 m				
Conversion error of analog values caused by non-linearity, calibration errors ex works and the resolution in the nominal range		0.5 % typically, 1 % max.				Voltage: 0.1 % typically, current/resistor 0.3 % typically
Potential isolation						
Per module		●	●	●	●	–
Fieldbus connection		Via AC500 CPU or all communication interface modules				
Voltage supply for the module		Internally via extension bus interface (I/O bus)				

AC500

Technical data

CD522 encoder module

The CD522 module offers accuracy and dynamic flexibility for a customized solution. It has two independent encoder inputs onboard and is easily configured using the Automation Builder software for 10 different operation modes and for frequencies up to 300 kHz (depending on CPU cycle time). The CD522 module also integrates outputs for pulses and for PWM as well as normal inputs and outputs, depending on selected encoder mode.

Type		CD522
Functionality		
Digital inputs/outputs		24 V DC, dedicated inputs/outputs can be used for specific counting functions. All unused inputs/outputs can be used as input/output with standard specification.
	Input options	Catch/Touch operation, counter value stored in separate variable on external event (rising or falling) Set to preset counter register with predefined value Set to reset counter register
	End value output	Output set when predefined value is reached
	Reference point initialization (RPI) input for relative encoder initialization	●
High-speed counter/encoder		
Integrated counters	Counter characteristics	2 counters (24 V DC, 5 V DC, differential and 1 V _{pp} sinus input)
	Counter mode	one 32 bits or two 16 bits
	Relative position encoder	X1, X2, X4
	Absolute SSI encoder	●
	Time frequency meter	●
	Frequency input	up to 300 kHz
PWM/pulse outputs		
Output mode specification	Number of outputs	2
	Push pull output	24 V DC, 100 mA max
	Current limitation	Thermal and overcurrent
PWM mode specification	Frequency	1...100 kHz
	Value	0...100 %
Pulse mode specification	Frequency	1...15 kHz
	Pulse emission	1...65535 pulses
	Number of pulses emitted indicator	0...100 %
Frequency mode specification	Frequency output	100 kHz
	Duty Cycle	Set to 50 %
Number of channels per module		
Digital	input	2
	output	2
Configurable channels DC (configurable as inputs or outputs)		8
Additional configuration of channels as		
Fast counter		Integrated 2 counter encoders
Connection via terminal unit		●
Digital Inputs		
Input	signal voltage	24 V DC
	time delay	8 ms typically configurable from 0.1 up to 32 ms
Input current per channel		
At input voltage	24 V DC	Typically 5 mA
	5 V DC	> 1 mA
	15 V DC	> 5 mA
	30 V DC	< 8 mA
Digital outputs		
Output voltage at signal state 1		UP – 0.8 V

AC500

Technical data

CD522 encoder module

Type	CD522	
Output current		
Nominal current per channel	0.5 A at UP = 24 V	
Maximum (total current of all channels)	8 A	
Residual current at signal state 0	< 0.5 mA	
Demagnetization when switching off inductive loads	By internal varistors	
Switching frequency		
For inductive load	Max. 0.5 Hz	
For lamp load	Max. 11 Hz with max. 5 W	
Short-circuit / Overload proofness	•	
Overload indication (I > 0.7 A)	After approx. 100 ms	
Output current limiting	•	
Proofness against reverse feeding of 24 V signals	•	
Maximum cable length for connected process signals		
Cable	shielded	1000 m
	unshielded	600 m
Potential isolation		
Per module	•	
Technical data of the high-speed inputs		
Number of channels per module	6	
Input type	24 V DC, 5 V DC / Differential / Sinus 1 Vpp	
Frequency	300 kHz	
Technical data of the fast outputs		
Number of channels	2	
Indication of the output signals	Brightness of the LED depends on the number of pulses emitted (0 % to 100 %) (pulse output mode only)	
Output current		
Rated value, per channel	100 mA at UP = 24 V	
Maximum value (all channels together, configurable outputs included)	8 A	
Leakage current with signal 0	< 0.5 mA	
Rated protection fuse on UP	10 A fast	
De-magnetization when inductive loads are switched off	with varistors integrated in the module	
Overload message (I > 0.1 x A)	Yes, after ca. 100 ms	
Output current limitation	Yes, automatic reactivation after short-circuit/overload	
Resistance to feedback against 24 V signals	Yes	
Process voltage UP		
Nominal voltage	24 V DC	
Maximum ripple	5 %	
Current consumption on UP		
Min. (module alone)	0.070 A	
Max. (min. + loads)	0.070 A + load	
Reverse polarity protection	•	
Fuse for process voltage UP	10 A miniature fuse	

AC500

Technical data

Analog/digital mixed I/O expansion modules

For all modules: max cable length for connected process signals is 1000 m for shielded cable and 600 m for unshielded ones. For all Input modules, the signal resolution for channel configuration is: -10...+10 V: 12 bit + sign; 0...10 V, 0...20 mA, 4...20 mA: 12 bits.

Type	DA501	
Number of Channels per Module		
Digital	inputs	16
	outputs	–
Analog	inputs	4
	outputs	2
Digital configurable channels DC (configurable as inputs or outputs)		8
Additional configuration of channels as		
Fast counter		Yes
Occupies max. 1 DO or DC when used as counter		Configuration of max. 2 channels per module. Operating modes see table on page 116
Connection via terminal unit TU 5xx		●
Digital inputs		
Input	signal voltage	24 V DC
	characteristic acc. to EN 61132-2	Type 1
0 signal		-3...+5 V DC
Undefined signal state		5...15 V DC
1 signal		15...30 V DC
Residual ripple, range for	0 signal	-3...+5 V DC
	1 signal	15...30 V DC
Input time delay (0 -> 1 or 1 -> 0)		8 ms typically, configurable from 0.1 up to 32 ms
Digital outputs		
Transistor outputs 24 V DC, 0.5 A		●
Readback of output		●
Outputs, supplied via process voltage UP		●
Switching of 24 V load		●
Output voltage at signal state 1		Process voltage UP - 0.8 V
Output current		
Nominal current per channel		500 mA at UP = 24 V DC
Maximum (total current of all channels)		4 A
Residual current at signal state 0		< 0.5 mA
Demagnetization when switching off inductive loads		By internal varistors
Analog inputs AI		Max. number per module and with regard to the configuration: AIs / Measuring points
Signal configuration per AI		●
0...10 V / -10 ... +10 V		4 / 4
0...20 mA / 4...20 mA		4 / 4
RTD using 2/3 wire needs 1/2 channel(s)		4 / 2
0...10 V using differential inputs, needs 2 channels		4 / 2
-10...+10 V using differential inputs, needs 2 channels		4 / 2
Digital signals (digital input)		4 / 4
Data when using the AI as digital input		
Input	time delay	8 ms typically, configurable from 0.1 up to 32 ms
	signal voltage	24 V DC
Outputs, single configurable as		
Possible configuration per AO		●
-10...+10 V		●
0...20 mA / 4...20 mA		●
Output resistance (load) when used as current output		0...500 Ω
Output loading capability when used as voltage output		±10 mA max.
Potential isolation		
Per module		●
Process voltage UP		
Nominal voltage		24 V DC
Maximum ripple		5 %
Current consumption on UP		
Min. (module alone)		0.070 A
Max. (min. + loads)		0.070 A + load
Reverse polarity protection		●
Fuse for process voltage UP		10 A miniature fuse
Approvals		See detailed page 220 or www.abb.com/plc

AC500

Technical data

DC541-CM interrupt I/O and fast counter module

In the operating mode counter, the channels can be configured as follows:

Input, Output, 32-bit up/down counter (uses C0...C3) as a 32-bit counter without limit, 32-bit periodic counter as a 32-bit counter with a limit, limiter for a 32-bit counter (limit channel 0), 32-bit up counter (forward counter) with the frequencies 50 kHz, 5 kHz and 2.5 kHz, pulse-width modulation (PWM) with a resolution of 10 kHz, time and frequency measurement, frequency output.

Type	DC541-CM	
Number of channels per module		
Configurable channels DC (configurable as inputs or outputs)	8	
Additional configuration of channels as		
Fast counter	Yes	
Connection via CPU terminal base. Occupies one communication module slot	•	
Digital inputs		
Input	signal voltage	24 V DC
	characteristic acc. to EN 61132-2	Type 1
0 signal	-3...+5 V DC	
Undefined signal state	5...15 V DC	
1 signal	5...30 V DC	
Input time delay (0 -> 1 or 1 -> 0)	20 µs Clamp to clamp - 300 µs with interrupt task	
Input current per channel		
At input voltage	24 V DC	5 mA typically
	5 V DC	> 1 mA
	15 V DC	> 5 mA
	30 V DC	< 8 mA
Digital outputs		
Transistor outputs 24 V DC, 0.5 A	•	
Readback of output	•	
Switching of 24 V load	•	
Output voltage at signal state 1	Process voltage UP minus 0.8 V	
Output current		
Nominal current per channel	500 mA at UP = 24 V	
Maximum (total current of all channels)	4 A	
Residual current at signal state 0	< 0.5 mA	
Demagnetization when switching off inductive loads	by internal varistors	
Potential isolation		
Per module	•	
Voltage supply for the module	Internally via backplane bus	

Interrupt I/O table

Configuration as		Configuration for channel no.					Max. no. of channels for this function	Remarks and notes regarding possible alternative combinations of the remaining channels (a and b)
		Chan. 0	Chan. 1	Chan. 2	Chan. 3	Chan. 4-7		
Mode 1: Interrupt functionality								
Interrupt	Digital input	1	1	1	1	4	8	Each channel can be configured individually as interrupt input or output
	Digital output	1	1	1	1	4	8	
Mode 2: Counting functionality								
Digital I/Os PWM (1)	Digital input	1	1	1	1	4	8	Usual input
	Digital output	1	1	1	1	4	8	Usual output
	PWM, resolution 10 kHz	1	1	1	1	4	8	Outputs and pulsed signal with and adjustable on-off ratio

(1) Counter and fast counter data available on technical documentation.

AC500

Technical data

AC500 Condition Monitoring CMS: FM502-CMS

The FM502-CMS function module offers precision and dynamic flexibility for customized solutions in condition monitoring, precise measurement or fast data logging applications. It has 16 fast, precise and synchronized analog inputs with 50k Samples/s (SPS), 24bit ADC resolution, completed with encoder inputs (incremental or absolute) with counter and additional DI and DC inputs/outputs onboard. It is easily configured using the Automation Builder software and the special libraries. Overall it has 12 different operation modes. One FM502 function module can be placed on the right side of PM592-ETH CPU with a special function module terminal base TF5x1, to interface directly to the CPU. While long measurements can be flexibly configured, started and stopped, all inputs are available in the I/O Image of CPU for immediate use (measurement, protection, control, ...)

Type	FM502-CMS	
Data storage		
Fast user data memory of FM502	128 MB (ca. 33 million Samples: e.g 40 s record length on 16 channels at 50k SPS or 5.8 h record length on 16 channels at 100 SPS or 93 h on 1 channel at 100 SPS)	
File Format delivered to PM592 flash	WAV (compact binary) per channel, all channels in one *.zip w. time stamp	
Analog inputs		
Number of channels	16 (synchronous sampled)	
Resolution	24 bit ADC, stored in DINT in WAV file (4byte per value)	
Accuracy at +25 °C	< +/- 0.1 %	
Accuracy over operating temperature and vibration	< +/- 0.5 %	
Sample rate / Bandwidth (High, 0 dB)	50k SPS / 20 kHz to 100 SPS / 40 Hz (digitally downsampled, selectable per channel)	
Indication of the input signal	One bicolor LED per channel for configuration, measurement status, error messages	
Input option:	IEPE (with Sensor supply current)	+ - 10V
Bandwidth low (- 3 dB)	digital < 0.1 Hz	digital < 0.1 Hz or DC (selectable)
Pass band high (- 3 dB)	analog > 90 kHz, digital > 24.5 kHz	
Stop band high (> - 100 dB)	analog > 1 MHz, digital > 27.5 kHz	
Dynamic Range (SFDR)	> 100 dB	
SINAD (300 Hz/1 kHz sine, 50 k SPS) 0dB from full scale	< -90 dB	< - 95 dB
IEPE Current Source per channel	Typ. 4.2 mA (+/- 7% over temperature)	(n.a.)
Resistance AI- to M (ground)	Typ ~ 270Ohm (PTC)	
Channel input impedance (AI+/AI-):		
< 1kHz	> 1 MOhm	> 2 MOhm
5kHz	> 100 kOhm	> 40 kOhm
10kHz	> 60 kOhm	> 25 kOhm
20kHz	> 40 kOhm	> 8 kOhm
Error detection	Short circuit, open wire	
Max. cable length, shielded (depending on sensor)	100 m	
Digital inputs/outputs		
	24 V DC, dedicated inputs/outputs can be used for specific counting functions. All unused inputs/outputs can be used as normal input/output with standard specification.	
Channels and types	2 DI + 2 DC (configurable inputs/outputs); Type 1, LED indication	
Input options	Catch/Touch operation, counter value stored in separate variable on external event (rising or falling) Set to preset counter register with predefined value Set to reset counter register	
End value output	Output set when predefined value is reached	
Reference point initialization (RPI) input for relative encoder initialization	•	
Input current p. channel @ V DC		
24 V DC	Typically 5 mA	
5 V DC	> 1 mA	
15 V DC	> 5 mA	
30 V DC	< 8 mA	

AC500

Technical data

Type	FM502-CMS
Digital outputs	
Output voltage at signal state 1	(L+) – 0.8 V
Output current	
Nominal current per channel	0.5 A at UP = 24 V
Residual current at signal state 0	< 0.5 mA
Demagnetization when switching off inductive loads	By internal varistors
Switching frequency	
For inductive load	Max. 0.5 Hz
For lamp load	Max. 11 Hz with max. 5 W
Short-circuit / Overload proofness	•
Overload indication (I > 0.7 A)	After approx. 100 ms
Output current limiting	•
Resistance against reverse feeding of 24 V signals	•
Maximum cable length for connected process signals	
shielded	1000 m
unshielded	600 m
High-speed counter/encoder	
Integrated counters	
Counter characteristics	2 counters (24 V DC, 5 V DC, differential RS422: 5 V or 1 Vpp sinus input)
Counter mode	one counter 32 bits or two counters 16 bits
Relative position encoder	X1, X2, X3
Absolute SSI encoder	•
Time frequency meter	•
Frequency input	up to 300 kHz
Additional configuration of channels as	
Fast counter	Integrated 2 counter encoders
high-speed inputs	
Number of channels, type per module	3 (A,B,Z), type 1
Input type	24 V DC 5 V DC / Differential / Sinus 1 Vpp
Frequency	up to 300 kHz (input filter: 50,500, 5 k, 20 k Hz)
Input frequency max. (frequency measurement only)	100 kHz (accuracy -0 %/+3 %)
Max. cable length, shielded (depending on sensor)	300 m 100 m
Fast outputs	
SSI CLK output B	f. optical Interface (according SSI): Pin 1.3 RS-422 differential (according SSI) Pins 1.3, 1.4
Output delay (0->1 or 1->0)	Max. 0.35 µs
Output current	≤ 10 mA
Switching frequency (selectable)	200 kHz, 500 kHz and 1 MHz
Short-circuit proof / overload proof	Yes
Output current limitation	Yes, automatic reactivation after short-circuit/overload
Resistance to feedback against 24V signals	Yes
Resistance to feedback against reverse polarity	Yes
Max. cable length, shielded (depending on sensor)	100 m
Process voltage L+	
Nominal voltage	24 V DC
Max. ripple	0,05
Current consumption from L+ (FM502 and PM592, no communication module)	Max. 0.43 A + max. 0.5 A per output
Inrush current from L+ (at power up, FM502 and PM592, no communication module)	1.2 A²s
Electrical isolation	Yes, (PM592 and FM502 to other I/O-Bus modules)
Max. power dissipation within the FM502 module	6.5 W (outputs unloaded)
5-V-encoder supply output	
Nominal voltage	5 V DC (+/- 5%), 100 mA max.

AC500

Technical data

AC500 communication modules

- Up to 4 communications modules can be used on an AC500 CPU
- No external power supply required.

Type	CM592-DP	CM582-DP	CM597-ETH	CM598-CN	CM588-CN	CM579-PNIO
Communication interfaces						
RJ45	–	–	● (x 2) (2)	–	–	● (x 2) (2)
RS-232 / 485	–	–	–	–	–	–
Terminal blocks (1)	–	–	–	●	●	–
Sub-D socket	●	●	–	–	–	–
Protocols	PROFIBUS DP V0/V1 master	PROFIBUS DP V0/V1 slave	Ethernet (TCP/IP, UDP/IP, Modbus TCP)	CANopen master	CANopen slave	PROFINET IO controller
CPU interface	8 kB Dual-port memory	8 kB Dual-port memory	8 kB Dual-port memory	8 kB Dual-port memory	8 kB Dual-port memory	8 kB Dual-port memory
Transfer Rate	9.6 kbit/s to 12 Mbit/s	9.6 kbit/s to 12 Mbit/s	10 / 100 Mbit/s	10 kbit/s to 1 Mbit/s	10 kbit/s to 1 Mbit/s	10 / 100 Mbit/s
Co-processor	Communication processor netX 100	Communication processor netX 100	Communication processor netX 100	Communication processor netX 100	Communication processor netX 100	Communication processor netX 100
Memory	–	–	–	–	–	–
Additional features	Multi master functionality Max. Number of subscribers: • 126 (V0) • 32 (V1)	–	Online access, ICMP (Ping), DHCP, IP configuration protocol, UDP data exchange, Modbus TCP	CAN 2.0A CAN 2.0B CANopen	NMT Slave PDO SDO server Heartbeat Nodeguard	RTC - Real-time Cyclic Protocol, Class 1 RTA - Real-time Acyclic Protocol DCP Discovery and Configuration Protocol CL-RPC - Connectionless Remote Procedure Call

04

Type	CM589-PNIO	CM589-PNIO-4	CM579-ETHCAT	CM574-RS	CM574-RCOM
Communication interfaces					
RJ45	● (x 2) (2)	● (x 2) (2)	● (x 2)	–	–
RS-232 / 485	–	–	–	● (x 2)	● (x 2)
Terminal blocks (1)	–	–	–	● (x 2)	● (x 2)
Sub-D socket	–	–	–	–	–
Protocols	PROFINET IO device	PROFINET IO 4 x devices	EtherCAT master	Serial COM ASCII, Modbus RTU, CS31	Serial RCOM/RCOM+
CPU interface	8 kB Dual-port memory	8 kB Dual-port memory	8 kB Dual-port memory	8 kB Dual-port memory	8 kB Dual-port memory
Transfer Rate	10 / 100 Mbit/s	10 / 100 Mbit/s	10 / 100 Mbit/s	9.6 kBit/s up to 187.5 kBit/s	2,4 kBit/s to 19.2 kBit/s
Co-processor	Communication processor netX 100	Communication processor netX 100	Communication processor netX 100	Programmable CPU like PM57x with PowerPC 50 MHz processor	PowerPC 50 MHz processor
Memory	–	–	–	256 kB program memory 384 kB data memory	–
Additional features	RTC - Real-time Cyclic Protocol, Class 1 RTA - Real-time Acyclic protocol DCP Discovery and Configuration Protocol LLDP - Link Layer Discovery Protocol	RTC - Real-time Cyclic Protocol, Class 1 RTA - Real-time Acyclic protocol DCP Discovery and Configuration Protocol LLDP - Link Layer Discovery Protocol	CoE (Can over Ethercat) process data (PDO) (cyclic) CoE Mailbox data (SDO) (acyclic) Distributed Clock (32-bit, 64-bit)	• Stand alone CPU in coupler module housing allowing to be used as standard serial interface or as free programmable serial interface coupler. • Independant internal CPU programmable for own communication protocol or data processing. • 2 x CS31 master, Modbus master/slave, free configurable, protocols ASCII.	–

(1) Plug-in terminal block included.

(2) 10 / 100 Mbit/s, full/half duplex with auto-sensing, 2-port switch integrated

AC500

Technical data

Communication interface modules

For all modules: max cable length for connected process signals is 1000 m for shielded cable and 600 m for unshielded ones. For all Input modules, the signal resolution for channel configuration is: -10...+10 V: 12 bits + sign; 0...10 V, 0...20 mA, 4...20 mA: 12 bits. Temperature: 0.1 °C.

Type	DC551-CS31	CI590-CS31-HA (1)	CI592-CS31
Communication Interface			
Protocol	Proprietary CS31 bus protocol on RS485 interface		
ID configuration	Per rotary switches on front face from 00d to 99d		
Field bus connection on terminal units	CS31 field bus, via terminal / redundant for CI590-CS31-HA on TU551-CS31 or TU552-CS31		
Number of Channels per Module			
Digital	inputs	8	8
	outputs	-	-
Analog	inputs	-	4
	outputs	-	2
Digital configurable channels DC (configurable as inputs or outputs)		16	8
Additional configuration of channels as			
Fast counter	Configuration of max. 2 channels per module		
Occupies max. 1 DO or DC when used as counter	●	●	●
Connection			
Via terminal unit TU5xx	●	●	●
Local I/O extension			
Max. number of extension modules	max. 7 x S500 extension modules (standard or eCo), up to 31 stations with up to 120 DIs/120 DOs or up to 32 AIs/32AOs per station		
		not for S500-eCo I/O modules	
Digital inputs			
Input	signal voltage	24 V DC	
	characteristic acc. to EN 61132-2	Type 1	
0 signal		-3...+5 V DC	
Undefined signal state		5...15 V DC	
1 signal		15...30 V DC	
Residual ripple, range for	0 signal	-3...+5 V DC	
	1 signal	15...30 V DC	
Input time delay (0 -> 1 or 1 -> 0)	8 ms typically, configurable from 0.1 up to 32 ms		
Digital outputs			
Transistor outputs 24 V DC, 0.5 A	●		
Readback of output	●		
Outputs, supplied via process voltage UP	●		
Switching of 24 V load	●		
Output voltage at signal state 1	Process voltage UP - 0.8 V		
Output current			
Nominal current per channel	500 mA at UP = 24 V DC		
Maximum (total current of all channels)	8 A	8 A	4 A
Residual current at signal state 0	< 0.5 mA		
Demagnetization when switching off inductive loads	By internal varistors		
Analog inputs AI			
Signal configuration per AI	Max. number per module and with regard to the configuration: AIs / Measuring points		
0...10 V / -10...+10 V	-	●	
0...20 mA / 4...20 mA	-	4 / 4	
RTD using 2/3 wire needs 1/2 channel(s)	-	4 / 2	
0...10 V using differential inputs, needs 2 channels	-	4 / 2	
-10...+10 V using differential inputs, needs 2 channels	-	4 / 2	
Digital signals (digital input)	-	4 / 4	

(1) Dedicated to High Availability.

AC500

Technical data

Communication interface modules

Type	DC551-CS31	CI590-CS31-HA (1)	CI592-CS31
Data when using the AI as digital input			
Input	time delay	–	8 ms typically, configurable from 0.1 up to 32 ms
	signal voltage	–	24 V DC
Outputs, single configurable as			
Possible configuration per AO		–	•
-10...+10 V		–	•
0...20 mA / 4...20 mA		–	•
Output	resistance (load) when used as current output	–	0...500 Ω
	loading capability when used as voltage output	–	±10 mA max.
Potential isolation			
Per module		•	•
Between fieldbus interface against the rest of the module		•	•
Voltage supply for the module		By external 24 V DC voltage via terminal UP	
Process voltage UP			
Nominal voltage		24 V DC	
Current consumption on UP			
Min. (module alone)		0.100 A	0.100 A
Max. (min. + loads)		0.100 A + load	0.100 A + load
Reverse polarity protection		•	
Fuse for process voltage UP		10 A miniature fuse	
Approvals		See detailed page 220 or www.abb.com/plc	

(1) Dedicated to High Availability.

AC500

Technical data

PROFIBUS-DP modules

Type	CI541-DP	CI542-DP
Communication Interface		
Protocol	PROFIBUS DP (DP-V0 and DP-V1 slave)	
ID configuration	Per rotary switches on front face from 00h to FFh	
Field bus connection on terminal units	Sub-D 9 poles on TU509, TU510 preferred but TU517/TU518 can be used with baud rate up to 1Mbaud	
Number of Channels per Module		
Digital	inputs	8
	outputs	8
Analog	inputs	–
	outputs	–
Digital configurable channels DC (configurable as inputs or outputs)	–	8
Additional configuration of channels as		
Fast counter (onboard I/O)	Configuration of max. 2 DI channels per module	
Occupies max 1 DO or DC when used as counter	●	
Connection		
Local I/O extension	●	
Max. number of extension modules	max. 10 x S500 extension modules (standard or eCo modules allowed). Fast counter from digital IO modules can be also used.	
Via terminal unit TU5xx	●	
Digital inputs		
Input	signal voltage	24 V DC
	characteristic acc. to EN 61132-2	Type 1
0 signal		-3...+5 V DC
Undefined signal state		5...15 V DC
1 signal		15...30 V DC
Residual ripple, range for	0 signal	-3...+5 V DC
	1 signal	15...30 V DC
Input time delay (0 -> 1 or 1 -> 0)	8 ms typically, configurable from 0.1 up to 32 ms	
Digital outputs		
Transistor outputs 24 V DC, 0.5 A	●	
Readback of output	–	● (on DC outputs)
Outputs, supplied via process voltage UP	●	
Switching of 24 V load	●	
Output voltage at signal state 1	Process voltage UP - 0.8 V	
Output current		
Nominal current per channel	500 mA at UP = 24 V DC	
Maximum (total current of all channels)	8 A	
Residual current at signal state 0	< 0.5 mA	
Demagnetization when switching off inductive loads	By internal varistors	
Analog Inputs AI	Max. number per module and with regard to the configuration: AIs / Measuring points	
Signal configuration per AI	4	–
0...10 V / -10...+10 V	4 / 4	–
0...20 mA / 4...20 mA	4 / 4	–
RTD using 2/3 wire needs 1/2 channel(s)	4 / 2	–
0...10 V using differential inputs, needs 2 channels	4 / 2	–
-10...+10 V using differential inputs, needs 2 channels	4 / 2	–
Digital signals (digital input)	4 / 4	–
Data when using the AI as digital input		
Input	Input time delay	8 ms typically, configurable from 0.1 up to 32 ms
	signal voltage	24 V DC

AC500

Technical data

PROFIBUS-DP modules

Type	CI541-DP	CI542-DP
Outputs, single configurable as		
Possible configuration per AO	●	–
-10...+10V	●	–
0...20 mA / 4...20 mA	●	–
Output resistance (load) when used as current output	0...500 Ω	–
loading capability when used as voltage output	±10 mA max.	–
Potential isolation		
Per module	●	●
Between fieldbus interface against the rest of the module	●	●
Between the channels		
input	–	–
output	–	–
Voltage supply for the module	By external 24 V DC voltage via terminal UP	
Process voltage UP		
Nominal voltage	24 V DC	
Current consumption on UP		
Min. (module alone)	0.260 A	
Max. (min. + loads)	0.260 A + load	
Reverse polarity protection	●	
Fuse for process voltage UP	10 A miniature fuse	
Approvals	See detailed page 220 or www.abb.com/plc	

AC500

Technical data

CANopen modules

Type	CI581-CN	CI582-CN	
Communication interface			
Protocol	CANopen slave, DS401 profile selectable using rotary switches		
ID configuration	Per rotary switches on front face for CANopen ID node from 00h to 7Fh and 80h to FFh for CANopen DS401 profile		
Field bus connection on terminal units	Terminal blocks on TU517/TU518 or TU509/TU510		
Number of channels per module			
Digital	inputs	8	
	outputs	8	
Analog	inputs	–	
	outputs	–	
Digital configurable channels DC (configurable as inputs or outputs)	–	8	
Additional configuration of channels as			
Fast counter (onboard I/O)	Configuration of max. 2 DI channels per module		
Occupies max. 1 DO or DC when used as counter	●	●	
Connection			
Local I/O extension	●		
Max. number of extension modules	max. 10 x S500 extension modules (standard or eCo modules are allowed)		
Via terminal unit TU5xx	●	●	
Digital inputs			
Input	signal voltage	24 V DC	
	characteristic acc. to EN 61132-2	Type 1	
0 signal		-3...+5 V DC	
Undefined signal state		5...15 V DC	
1 signal		15...30 V DC	
Residual ripple, range for	0 signal	-3...+5 V DC	
	1 signal	15...30 V DC	
Input time delay (0 -> 1 or 1 -> 0)	8 ms typically, configurable from 0.1 up to 32 ms		
Digital outputs			
Transistor outputs 24 V DC, 0.5 A	●		
Readback of output	–	● (on DC outputs)	
Outputs, supplied via process voltage UP	●		
Switching of 24 V load	●		
Output voltage at signal state 1	Process voltage UP - 0.8 V		
Output current			
Nominal current per channel	500 mA at UP = 24 V DC		
Maximum (total current of all channels)	8 A		
Residual current at signal state 0	< 0.5 mA		
Demagnetization when switching off inductive loads	By internal varistors		
Analog Inputs AI	Max. number per module and with regard to the configuration: AIs / Measuring points		
Signal configuration per AI	4	–	
0...10 V / -10...+10 V	4 / 4	–	
0...20 mA / 4...20 mA	4 / 4	–	
RTD using 2/3 wire needs 1/2 channel(s)	4 / 2	–	
0...10 V using differential inputs, needs 2 channels	4 / 2	–	
-10...+10 V using differential inputs, needs 2 channels	4 / 2	–	
Digital signals (digital input)	4 / 4	–	
Data when using the AI as digital input			
Input	time delay	8 ms typically, configurable from 0.1 up to 32 ms	–
	signal voltage	24 V DC	–

AC500

Technical data

CANopen modules

Type	CI581-CN	CI582-CN
Outputs, single configurable as		
Possible configuration per AO	•	–
-10...+10 V	•	–
0...20 mA / 4...20 mA	•	–
Output resistance (load) when used as current output	0...500 Ω	–
loading capability when used as voltage output	±10 mA max.	–
Potential isolation		
Per module	•	•
Between fieldbus interface against the rest of the module	•	•
Between the channels		
input	–	–
output	–	–
Voltage supply for the module	By external 24 V DC voltage via terminal UP	
Process voltage UP		
Nominal voltage	24 V DC	
Current consumption on UP		
Min. (module alone)	0.260 A	
Max. (min. + loads)	0.260 A + load	
Reverse polarity protection	•	
Fuse for process voltage UP	10 A miniature fuse	
Approvals	See detailed page 220 or www.abb.com/plc	

AC500

Technical data

PROFINET IO RT device modules

Type	CI501-PNIO	CI502-PNIO	CI504-PNIO	CI506-PNIO
Communication interface				
Ethernet Interface				
Main protocol	PROFINET IO RT device			
ID Device configuration	By rotary switch on the front side, from 00h to FFh			
Ethernet connection on terminal units	2 x RJ45 with switch functionality for simple daisy chain on TU507-ETH or TU508-ETH or TU520-ETH			
Gateway Interface				
Gateway to	-	-	3 x RS232 / RS422 / RS485 ASCII serial interfaces	CAN / CANopen Master + 2 x RS232 / RS422 / RS485 ASCII serial interfaces
Fieldbus Protocol used	-	-	-	CAN 2A/2B Master - CANopen Master (1)
CAN physical interface	-	-	-	1 x 10 poles pluggable spring connector
Baudrate	-	-	-	Baudrate up to 1 MBit/s, Support for up to 126 CANopen Slaves
Serial interface				
Protocol used	-	-	3 x RS232 / RS422 or RS485	2 x RS232 / RS422 or RS485
Baudrate	-	-	Configurable from 300 bit/s to 115200 bit/s	
Fieldbus or serial connection on terminal units	-	-	3 x pluggable terminal blocks with spring on TU520-ETH	
Number of channels per module				
Digital	inputs	8	8	-
	outputs	8	8	-
Analog	inputs	4	-	-
	outputs	2	-	-
Digital configurable channels DC (configurable as inputs or outputs)		-	8	-
Additional configuration of channels as				
Fast counter (onboard I/O)		Configuration of max. 2 DI channels per module		
Occupies max. 1 DO or DC when used as counter		●	-	-
Connection				
Local I/O extension		●	●	●
Max. number of extension modules		max. 10 x S500 extension modules (standard or eCo modules allowed). Fast counter from digital IO modules can be also used.		
Via terminal unit TU5xx		●	●	●
Digital inputs				
Input	signal voltage	24 V DC		
	characteristic acc. to EN 61132-2	Type 1		
0 signal		-3...+5 V DC		
Undefined signal state		5...15 V DC		
1 signal		15...30 V DC		
Residual ripple, range for	0 signal	-3...+5 V DC		
	1 signal	15...30 V DC		
Input time delay (0 -> 1 or 1 -> 0)		8 ms typically, configurable from 0.1 up to 32 ms		
Digital outputs				
Transistor outputs 24 V DC, 0.5 A		●	-	-
Readback of output		-	● (on DC outputs)	-
Outputs, supplied via process voltage UP		●	-	-
Switching of 24 V load		●	-	-
Output voltage at signal state 1		Process voltage UP - 0.8 V		

(1) Not simultaneously.

AC500

Technical data

PROFINET IO RT device modules

Type	CI501-PNIO	CI502-PNIO	CI504-PNIO	CI506-PNIO
Output current				
Nominal current per channel	500 mA at UP = 24 V DC		–	–
Maximum (total current of all channels)	8 A		–	–
Residual current at signal state 0	< 0.5 mA		–	–
Demagnetization when switching off inductive loads	By internal varistors		–	–
Analog inputs AI				
	Max. number per module and with regard to the configuration: AIs / Measuring points			
Signal configuration per AI	4	–	–	–
0...10 V / -10... +10 V	4 / 4	–	–	–
0...20 mA / 4...20 mA	4 / 4	–	–	–
RTD using 2/3 wire needs 1/2 channel(s)	4 / 2	–	–	–
0...10 V using differential inputs, needs 2 channels	4 / 2	–	–	–
-10...+10 V using differential inputs, needs 2 channels	4 / 2	–	–	–
Digital signals (digital input)	4 / 4	–	–	–
Data when using the AI as digital input				
Input	time delay	8 ms typically, configurable from 0.1 up to 32 ms	–	–
	signal voltage	24 V DC	–	–
Outputs, single configurable as				
Possible configuration per AO	●	–	–	–
-10...+10 V	●	–	–	–
0...20 mA / 4...20 mA	●	–	–	–
Output	resistance (load) when used as current output	0...500 Ω	–	–
	loading capability when used as voltage output	±10 mA max.	–	–
Potential isolation				
Per module	●	●	●	●
Between Ethernet interface against the rest of the module	●	●	●	●
Voltage supply for the module	By external 24 V DC voltage via terminal UP			
Process voltage UP				
Nominal voltage	24 V DC			
Current consumption on UP				
	min. (module alone)	0.260 A	0.150 A	
	max. (min. + loads)	0.260 A + load	0.150 A	
Reverse polarity protection	●			
Fuse for process voltage UP	10 A miniature fuse			
Approvals	See detailed page 220 or www.abb.com/plc			

(1) Not simultaneously.

AC500

Technical data

EtherCAT modules

Type	CI511-ETHCAT	CI512-ETHCAT	
Communication interface			
Protocol	EtherCAT slave with CAM-Switch configurable function on the digital outputs		
ID Device configuration	Address is defined by position on Ethernet bus		
Field bus connection on TUs	2 x RJ45 with switch functionality for simple daisy chain on TU507-ETH or TU508-ETH		
Number of channels per module			
Digital	inputs	8	8
	outputs	8	8
Analog	inputs	4	-
	outputs	2	-
Digital configurable channels DC (configurable as inputs or outputs)	-	-	8
Additional configuration of channels as			
Fast counter (onboard I/O)	-	-	-
Occupies max. 1 DO or DC when used as counter	-	-	-
Connection			
Local I/O extension	●	-	-
Max. number of extension modules	max. 10 x S500 extension modules (standard or eCo modules allowed). Fast counter from digital IO modules can be also used.		
Via terminal unit TU5xx	●	-	-
Digital inputs			
Input signal voltage	24 V DC		
Input characteristic acc. to EN 61 132-2	Type 1		
0 signal	-3...+5 V DC		
Undefined signal state	5...15 V DC		
1 signal	15...30 V DC		
Residual ripple, range for	0 signal	-3...+5 V DC	
	1 signal	15...30 V DC	
Input time delay (0 -> 1 or 1 -> 0)	8 ms typically, configurable from 0.1 up to 32 ms		
Digital outputs			
Transistor outputs 24 V DC, 0.5 A	●	-	-
Readback of output	-	●	(on DC outputs)
Outputs, supplied via process voltage UP	●	-	-
Switching of 24 V load	●	-	-
Output voltage at signal state 1	Process voltage UP - 0.8 V		
Output current			
Nominal current per channel	500 mA at UP = 24 V DC		
Maximum (total current of all channels)	8 A		
Residual current at signal state 0	< 0.5 mA		
Demagnetization when switching off inductive loads	By internal varistors		
Analog inputs AI			Max. number per module and with regard to the configuration: AIs / Measuring points
Signal configuration per AI	4	-	-
0...10 V / -10 V... +10 V	4 / 4	-	-
0...20 mA / 4...20 mA	4 / 4	-	-
RTD using 2/3 wire needs 1/2 channel(s)	4 / 2	-	-
0...10 V using differential inputs, needs 2 channels	4 / 2	-	-
-10...+10 V using differential inputs, needs 2 channels	4 / 2	-	-
Digital signals (digital input)	4 / 4	-	-
Data when using the AI as digital input			
Input	time delay	8 ms typically, configurable from 0.1 up to 32 ms	-
	signal voltage	24 V DC	-

AC500

Technical data

EtherCAT modules

Type	CI511-ETHCAT	CI512-ETHCAT
Outputs, single configurable as:		
Possible configuration per AO	•	–
-10...+10 V	•	–
0...20 mA / 4...20 mA	•	–
Output resistance (load) when used as current output	0...500 Ω	–
Output loading capability when used as voltage output	±10 mA max.	–
Potential isolation		
Per module	•	•
Between Ethernet interface against the rest of the module	•	•
Between the channels		
input	–	–
output	–	–
Voltage supply for the module	By external 24 V DC voltage via terminal UP	
Process voltage UP		
Nominal voltage	24 V DC	
Current consumption on UP		
min. (module alone)	0.260 A	
max. (min. + loads)	0.260 A + load	
Reverse polarity protection	•	
Fuse for process voltage UP	10 A miniature fuse	
Approvals	See detailed page 220 or www.abb.com/plc	

AC500

Technical data

Modbus TCP modules

Type	CI521-MODTCP	CI522-MODTCP	
Communication interface			
Ethernet Interface			
Main protocol	Modbus TCP		
ID Device configuration	By rotary switch on the front side, from 00h to FFh		
Ethernet connection on terminal units	2 x RJ45 with switch functionality for simple daisy chain on TU507-ETH or TU508-ETH		
Number of channels per module			
Digital	inputs	8	8
	outputs	8	8
Analog	inputs	4	–
	outputs	2	–
Digital configurable channels DC (configurable as inputs or outputs)		–	8
Additional configuration of channels as			
Fast counter (onboard I/O)	Configuration of max. 2 DI channels per module		
Occupies max. 1 DO or DC when used as counter	●		
Connection			
Local I/O extension	●		
Max. number of extension modules	max. 10 x S500 extension modules (standard or eCo modules allowed). Fast counter from digital IO modules can be also used.		
Via terminal unit TU5xx	●	●	
Digital inputs			
Input	signal voltage	24 V DC	
	characteristic acc. to EN 61132-2	Type 1	
0 signal	–3...+5 V DC		
Undefined signal state	5...15 V DC		
1 signal	15...30 V DC		
Residual ripple, range for	0 signal	–3...+5 V DC	
	1 signal	15...30 V DC	
Input time delay (0 -> 1 or 1 -> 0)	8 ms typically, configurable from 0.1 up to 32 ms		
Digital outputs			
Transistor outputs 24 V DC, 0.5 A	●		
Readback of output	–	● (on DC outputs)	
Outputs, supplied via process voltage UP	●		
Switching of 24 V load	●		
Output voltage at signal state 1	Process voltage UP - 0.8 V		
Output current			
Nominal current per channel	500 mA at UP = 24 V DC		
Maximum (total current of all channels)	8 A		
Residual current at signal state 0	< 0.5 mA		
Demagnetization when switching off inductive loads	By internal varistors		
Analog inputs AI			
Max. number per module and with regard to the configuration: AIs / Measuring points			
Signal configuration per AI	4	–	
0...10 V / -10... +10 V	4 / 4	–	
0...20 mA / 4...20 mA	4 / 4	–	
RTD using 2/3 wire needs 1/2 channel(s)	4 / 2	–	
0...10 V using differential inputs, needs 2 channels	4 / 2	–	
-10...+10 V using differential inputs, needs 2 channels	4 / 2	–	
Digital signals (digital input)	4 / 4	–	

(1) Not simultaneously.

AC500

Technical data

Modbus TCP modules

Type		CI521-MODTCP	CI522-MODTCP
Data when using the AI as digital input			
Input	time delay	8 ms typically, configurable from 0.1 up to 32 ms	–
	signal voltage	24 V DC	–
Outputs, single configurable as			
Possible configuration per AO		•	–
-10...+10 V		•	–
0...20 mA / 4...20 mA		•	–
Output	resistance (load) when used as current output	0...500 Ω	–
	loading capability when used as voltage output	±10 mA max.	–
Potential isolation			
Per module		•	•
Between Ethernet interface against the rest of the module		•	•
Voltage supply for the module		By external 24 V DC voltage via terminal UP	
Process voltage UP			
Nominal voltage		24 V DC	
Current consumption on UP			
min. (module alone)		0.260 A	
max. (min. + loads)		0.260 A + load	
Reverse polarity protection		•	
Fuse for process voltage UP		10 A miniature fuse	
Approvals		See detailed page 220 or www.abb.com/plc	

(1) Not simultaneously.

AC500

Technical data

CS31 functionality

	AC500 CPU with integrated CS31 interface	S500 I/O with communication interface DC551-CS31 CI590-CS31-HA CI592-CS31
Master	Yes, at COM1	–
Slave	No	Yes / Redundant for CI590-CS31-HA
Protocols supported	ABB CS31 protocol	
Diagnosis		
Error indication	On LCD display of the CPU / AC500-eCo error LED	Via module LEDs
Online diagnosis	Yes	
Error code	Errors are recorded in the diagnosis system of the CPU	
Associated function blocks	Yes	
Physical layer		
Connection	Plug at COM1	Screw-type or spring-type terminals
Baud rate	187.5 kbit/s	
Distance	AC500-eCo: up to 50 m and up to 500 m using the isolator TK506 / AC500: up to 500 m; up to 2000 m using a repeater	
Max. number of modules on fieldbus	31 modules max. Please note: The CS31 bus interface occupies one or two module addresses (if counters are configured onboard or if the module is a mixed digital analog module). Depending on the configuration, or if the module contains also mixed digital analog I/O, connected extension modules can occupy further module addresses.	
Configuration		
Station address configuration	No	Using rotary switches (99 max.)

Digital and mixed signal I/O modules, "Fast Counter" operating modes. Not applicable for DC541 or eCo-I/O modules (1)

Operating mode, configured in the user program of the AC500	Occupied inputs DI or DC	Occupied outputs DO or DC	Maximum counting frequency kHz
0 No counter	0	0	–
1 One count-up counter with "end value reached" indication	1	1	50
2 One count-up counter with "enable" input and "end value reached" indication	2	1	50
3 Two up/down counters	2	0	50
4 Two up/down counters with 1 counting input inverted	2	0	50
5 One up/down counter with "dynamic set" input	2	0	50
6 One up/down counter with "dynamic set" input	2	0	50
7 One up/down counter with directional discriminator For synchro transmitters using two counting pulses with an offset of 90° (track A and B)	2	0	50
8 –	0	0	–
9 One up/down counter with directional discriminator and double evaluation For synchro transmitters using two counting pulses with an offset of 90° towards each other (track A and B)	2	0	30
10 One up/down counter with directional discriminator and fourfold evaluation For synchro transmitters using two counting pulses with an offset of 90° towards each other (track A and B)	2	0	15

(1) See technical documentation for details.

AC500

System data

Environmental Conditions

Process and supply voltages

24 V DC	Voltage	24 V (-15%, +20%)
	Protection against reverse polarity	yes
120V...240V AC Wide Range Supply	Voltage	120...240 V (-15 %, +10 %)
	Frequency	50/60 Hz (-6 %, +4%)
Allowed interruptions of power supply	DC supply	Interruption < 10 ms, time between 2 interruptions > 1 s, PS2
	AC supply	Interruption < 0.5 periods, time between 2 interruptions > 1 s

Important: Exceeding the maximum process and supply voltages could lead to unrecoverable damage of the system. The system could be destroyed. For the supply of the modules, power supply units according to PELV or SELV specifications must be used. The creepage distances and clearances meet the requirements of the overvoltage category II, pollution degree 2.

Temperature

Operating	0 °C ... +60 °C	horizontal mounting of modules
	0 °C ... +40 °C	vertical mounting of modules and output load reduced to 50 % per group
Storage / Transport	-40 °C ... +70 °C	

Humidity

Operating / Storage	Max 95 % r. H. without condensation
---------------------	-------------------------------------

Air pressure

Operating	-1000 m ... 2000 m (1080 hPa ... 800 hPa)
-----------	---

Electromagnetic Compatibility

Radiated emission (radio disturbances)	Yes, according to: CISPR 16-2-3
Conducted emission (radio disturbances)	Yes, according to: CISPR 16-2-1, CISPR 16-1-2
Electrostatic discharge (ESD)	Yes, according to: IEC 61000-4-2, zone B, criterion B Electrostatic voltage in case of air discharge: 8 kV Electrostatic voltage in case of contact discharge: 6 kV
Fast transient interference voltages (burst)	Yes, according to: IEC 61000-4-4, zone B, criterion B Supply voltage units (DC): 2 kV Supply voltage units (AC): 2 kV Digital inputs/outputs (24 V DC): 1 kV Digital inputs/outputs (120...240 V AC): 2 kV Analog inputs/outputs: 1 kV Communication lines shielded: 1 kV I/O supply (DC-out): 1 kV
High energy transient interference voltages (surge)	Yes, according to: IEC 61000-4-5, zone B, criterion B Supply voltage units (DC): 1 kV CM* / 0.5 kV DM* Supply voltage units (AC): 2 kV CM* / 1 kV DM* Digital inputs/outputs (24 V DC): 1 kV CM* / 0.5 kV DM* Digital inputs/outputs (120...240 V AC): 2 kV CM* / 1 kV DM* Analog inputs/outputs: 1 kV CM* / 0.5 kV DM* Communication lines shielded: 1 kV CM* I/O supply (DC-out): 0,5 kV CM* / 0.5 kV DM*

* CM = Common Mode, * DM = Differential Mode

AC500

System data

Environmental Conditions

Influence of radiated disturbances	Yes, according to: IEC 61000-4-3, zone B, criterion A Test field strength: 10 V/m
Influence of line-conducted interferences	Yes, according to: IEC 61000-4-6, zone B, criterion A Test voltage: 10 V
Influence of power frequency magnetic fields	Yes, according to: IEC 61000-4-8, zone B, criterion A 30 A/m 50 Hz 30 A/m 60 Hz

In order to prevent malfunctions, it is recommended, that the operating personnel discharge themselves prior to touching communication connectors or perform other suitable measures to reduce effects of electrostatic discharges.

WARNING!

Risk of malfunctions and damages to persons!

Unused slots for Communication Modules are not protected against accidentally touch. Dust and Dirt may cause contact problems and malfunctions.

Unused slots for Communication Modules must be covered with Dummy Communication Modules ("TA524 - Dummy Communication Module").

I/O-Bus connectors must not be touched during operation.

Environmental Tests

Storage	IEC 60068-2-1 Test Ab: cold withstand test -40 °C / 16 h IEC 60068-2-2 Test Bb: dry heat withstand test +70 °C / 16 h
Humidity	IEC 60068-2-30 Test Db: Cyclic (12 h / 12 h) Damp-Heat Test 55 °C, 93 % r. H. / 25 °C, 95 % r. H., 2 cycles
Vibration resistance	IEC 61131-2 / IEC 60068-2-6: 15 Hz ... 150 Hz, 1 g (with SD Memory Card inserted)
Shock resistance	IEC 60068-2-27: all 3 axes 15 g, 11 ms, half-sinusoidal

Mechanical Data

Wiring method	Spring terminals / Screw terminals
Degree of protection	IP 20
Vibration resistance	Yes, according to: IEC 61131-2 IEC 60068-2-6
Shock resistance	Yes, according to: IEC 61131-2 IEC 60068-2-27
Assembly position	Horizontal Vertical
Assembly on DIN rail	DIN rail type According to IEC 60715 35 mm, depth 7.5 mm or 15 mm
Assembly with screws	Screw diameter Fastening torque 4 mm 1.2 Nm

Main dimensions mm, inches

Type	Nr communication modules	Length L	
		mm	inches
TB511-ETH	1	95.5	3.76
TB521-ETH / TB523-2ETH	2	123.5	4.86
TB541-ETH	4	179.5	7.07
TB5600-2ETH	0	67.5	2.66
TB5610-2ETH	1	95.5	3.76
TB5620-2ETH	2	123.5	4.86
TB5640-2ETH	4	179.5	7.07

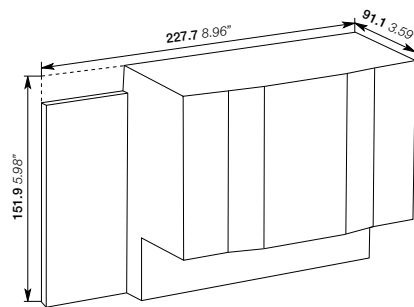
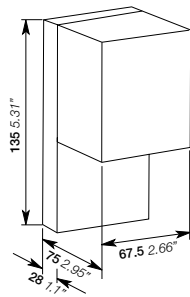
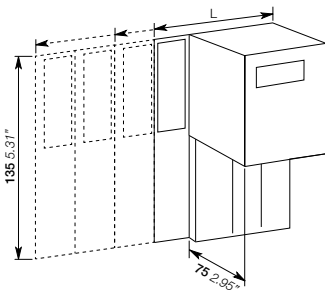

AC500-XC

PLC operating in eXtreme Conditions

123	Key features
124–134	Ordering data
135–161	Technical data
162–164	System data

79

ABB

PM592



SYS
BATT
I/O-Bus

ETH
FBP
COM1
COM2



PWR



RUN



ERR



WARNING
Use of
incorrect
battery may
cause fire or
explosion!

RUN
VAL
ESC
OK

DIAG
CFG





MC
502

← INSERT
→ PUSH

UP 24VDC 10W

CPU

ADDR
x 10H
ADDR
x 01H

AC500-XC

Key features



—

• Lower lifetime cost and many of the traditional practices are not required, such as: HVAC for the panel, shock absorbers, door sealing, etc...

—

• Resistance to:

- High humidity
- Salt mist
- Vibration
- High altitude
- Corrosive gases
- Temperature: from -40 to +70 °C

—

All the benefits from AC500 range: Automation Builder engineering suite, I/O modules, scalable and flexible, same high performance communication, libraries and web services.

AC500-XC

Ordering data

AC500 CPUs

- 2 internal serial interfaces, RS232 / RS485 configurable
- Display and 8 function keys for diagnosis and status
- Centrally expandable with up to 10 I/O modules (S500) for a total of 320 Digital I/Os or 160 Analog I/Os
- Simultaneous operation of up to 4 external communication modules in any desired combination
- Optional SD card for data storage and program backup
- Can also be used as slave for PROFIBUS DP, CANopen or PROFINET IO using CM582-DP-XC, CM588-CN-XC or CM589-PNIO-XC slave communication modules
- Ethernet version provides web server and IEC 60870-5-104 remote control protocol.

Program memory kB	Cycle time in μ s per instruction min. Bit/Word/Float. point	Integrated communication	Type	Order code	Price	Weight (1 pce) kg
512	0.06 / 0.09 / 0.7	Ethernet (2), 2 x serial	PM573-ETH-XC (1)	1SAP330300R0271		0.150
512	0.05 / 0.06 / 0.5	2 x serial	PM582-XC	1SAP340200R0201		0.135
1024	0.05 / 0.06 / 0.5	Ethernet (2), 2 x serial	PM583-ETH-XC (1)	1SAP340300R0271		0.150
4096	0.002 / 0.004 / 0.004	Ethernet (2), 2 x serial	PM591-ETH-XC (1)	1SAP350100R0271		0.150
4096	0.002 / 0.004 / 0.004	Ethernet (2), 2 x serial	PM592-ETH-XC (1)(3)	1SAP350200R0271		0.150



PM573-ETH-XC



PM592-ETH-XC

AC500 CPU PM595

- 2 Ethernet interfaces with integrated switch and software configurable protocol (PROFINET IO Controller, EtherCAT Master or Ethernet e.g. Modbus TCP client/server)
- 2 independent Ethernet interfaces for programming, online access, web server, IEC 60870-5-104 protocol e.g.
- 2 serial interfaces, RS232 / RS485 configurable
- Centrally expandable with up to 10 I/O modules (S500 and/or S500-eCo modules allowed)
- Simultaneous operation of up to 2 external communication modules in any desired combination, no need of additional terminal base

Program memory MB	Cycle time in μ s per instruction min. Bit/Word/Float. point	Integrated communication	Type	Order code	Price	Weight (1 pce) kg
16	0.0006/0.001/0.001	2 x Ethernet (2 Ports switch), 2 x Ethernet (2), 2 x serial	PM595-4ETH-M-XC (3)	1SAP351500R0279		1.050

(1) Ethernet communication.

(2) Provides integrated web server and IEC 60870-5-104 remote control protocol on each interface independently.

(3) Provides integrated 4 GB flashdisk for user data storage and data logging.



PM595-4ETH-M-XC

AC500-XC

Ordering data

Terminal base

- For mounting and connection of the CPUs and communication modules, not needed for PM595
- 1 to 4 plug-in communication modules
- Connection for communication coupler integrated in the CPU
- I/O interface for direct connection of up to 10 expansion modules
- Connection COM1: 9-pole pluggable terminal block
- Connection COM2: D-Sub 9 (socket).

Number of coupler slots	Connection for coupler integrated in the CPU	Type	Order code	Price	Weight (1 pce) kg
1	Ethernet RJ45	TB511-ETH-XC	1SAP311100R0270		0.215
2	Ethernet RJ45	TB521-ETH-XC	1SAP312100R0270		0.215
4	Ethernet RJ45	TB541-ETH-XC	1SAP314100R0270		0.215



TB511-ETH-XC



TB541-ETH-XC

AC500-XC

Ordering data

AC500 Condition Monitoring CMS-XC

- PLC integrated condition monitoring and fast protection for high frequency signals (vibration, current, voltage, speed/encoder)
- FM502-CMS module needs function module terminal base TF5x1 for direct interfacing to CPU, communication couplers, other I/O
 - for stand-alone or control/safety integrated condition monitoring
- PM592 CPU to be used on same TF5x1 for data storage and signal processing or communication
 - C-code interface for own complex diagnosis algorithms, 4GB Flash disk for raw fingerprints and indicator trending
- FM502-CMS module:
 - 16 fast, precise analog inputs, all synchronously sampled; configurable as IEPE or +-10V
 - individual measurement configuration (start, stop, trigger) per channel
 - per channel up to 50ksamples/s and 24bit ADC resolution, adjustable sampling
 - encoder inputs (5V or 24V) up to 300kHz counter; 12 modes, incl. absolute SSI (1MHz)
 - fast data logging, compact WAV-Files delivered automatically to CPU, incl. synchronized encoder signal if configured
 - analogue values always available for fast protection in I/O image of CPU
- Included in Automation Builder: Configuration, libraries for CMS control and wav file handling, examples
- Available download package: Signal processing library, example programs with simple diagnosis, logging and automated triggering (2)

Number of coupler slots	Description	Type	Order code	Price	Weight (1 pce) kg
n.a.	Function Module for Condition Monitoring Systems, 16AI, 2DI, 2DC, 1x Encoder (A, B, Z)	FM502-CMS-XC	1SAP460400R0001		0.215
0	Function module terminal base for FM502, no coupler slots, 1x ETHERNET, 1x serial, spring terminals, 24VDC	TF501-CMS-XC (1)	1SAP317000R0271		0.350
2	Function module terminal base for FM502, 2x coupler slots, 1x ETHERNET, 1x serial, spring terminals, 24VDC	TF521-CMS-XC (1)	1SAP317200R0271		0.400

(1) Can only be used together with FM502 and PM592-ETH

(2) Download of Package under "Application Examples" at www.abb.com/plc



FM502-CMS-XC



TF501-CMS-XC



TF521-CMS-XC

AC500-XC

Ordering data

AC500-XC V3 CPUs (2)

- 1x internal serial interface, RS232 / RS485 configurable (ACSII or Modbus RTU Master/Slave)
- 2x independant Ethernet interfaces which can also be used as switch and software configurable protocols like PROFINET IO Controller (2)(3), Ethernet IP Adapter (2)(3), EtherCAT Master (2)(3), IEC60870-5-104 or IEC61850 (3)
- Web server with WebVisu HTML5 and optional Remote Target Visu licensed for use with CP600 without Web interface
- 1x internal CAN interface, with CANopen Master/Slave, CAN 2A/2B and J1939 protocols
- Display and 8 function keys for diagnosis and status
- Centrally expandable with up to 10 I/O modules, 320 I/Os (S500 and/or S500-eCo modules allowed)
- Simultaneous operation of several external communication modules in any desired combination
- To be used exclusively with new TB56xx-2ETH
- Optional SD card for data storage and program backup
- To be used only with Automation Builder 2.x

Program / Data memory MB	Cycle time in μ s per instruction min. Bit/Word/Float. point	Integrated communication	Type	Order code	Price	Weight (1 pce) kg
8	0.020 / 0.020 / 0.120	2 x Ethernet with configurable protocols PROFINET IO Controller (2)(3) / EtherCAT Master (2)(3) or EthernetIP (2)(3), 1 x serial, 1x CAN interface	PM5630-2ETH-XC (1) (2) (4)	1SAP331000R0278		0.135
80	0.010 / 0.010 / 0.010	2 x Ethernet with configurable protocols PROFINET IO Controller (2)(3) / EtherCAT Master (2)(3) or EthernetIP (2)(3), 1 x serial, 1x CAN interface	PM5650-2ETH-XC (1) (2) (4)	1SAP341000R0278		0.135
160	0.002 / 0.002 / 0.002	2 x Ethernet with configurable protocols PROFINET IO Controller (2) / EtherCAT Master (2) or EthernetIP (2)(3), 1 x serial, 1x CAN interface	PM5670-2ETH-XC (1) (2) (4)	1SAP351000R0278		0.135
160 / 8GB	0.002 / 0.002 / 0.002	2 x Ethernet with configurable protocols PROFINET IO Controller (2) / EtherCAT Master (2) or EthernetIP (2)(3), 1 x serial, 1x CAN interface	PM5675-2ETH-XC (1) (2) (4)	1SAP351500R0278		0.150

(1) Ethernet communication provides integrated web server, IEC 60870-5-104 remote control protocol and OPC UA Server on each interface independently.

(2) Availability on demand.

(3) Some communication protocols are licensed see following lines

(4) Only to be used with dedicated terminal base TB56xx-2ETH



PM5650-2ETH-XC

Feature licenses

Some HW or FW features need to be licensed to be used on the new CPU. Which allows:

- more flexibility
- better adaptation to the needs

License Type	CPU runtime license to be used on internal Ethernet interface	Type	Order code	Price
HW	Modbus TCP HA runtime license	PS5601-HA-MTCP	1SAP195400R0101	
HW	IEC 61850 protocol runtime license	PS5602-61850	1SAP195600R0101	
HW	Remote target Visu runtime license for use with CP600	PS5603-RTVISU	1SAP195700R0101	

AC500-XC

Ordering data

AC500-XC V3 Terminal base (2)

- For mounting and connection of the AC500-XC V3 CPUs only and communication modules
- 0, 1, 2, 4 or up to 6 (2) plug-in communication modules
- Connection for communication coupler integrated in the CPU
- I/O interface for direct connection of up to 10 expansion modules
- Connection COM1: 9-pole pluggable spring terminal block
- Connection CAN: 2x 5-pole pluggable spring terminal block
- 2x RJ45 Ethernet interfaces with configurable switch functionality

Number of coupler slots	Connection for coupler integrated in the CPU	Type	Order code	Price	Weight (1 pce) kg
0	2x RJ45 for Ethernet, 1x serial COM1 with pluggable spring connector and 1x2x5 poles pluggable spring connector for CAN/CANopen interface	TB5600-2ETH-XC (2)	1SAP310300R0278		0.165
1		TB5610-2ETH-XC (2)	1SAP311300R0278		0.190
2		TB5620-2ETH-XC (2)	1SAP312300R0278		0.215
4		TB5640-2ETH-XC (2)	1SAP314300R0278		0.265
6		TB5660-2ETH-XC (2)	1SAP316300R0278		0.315

2) Availability on demand.

05



TB5600-2ETH-XC



TB5610-2ETH-XC



TB5620-2ETH-XC



TB5640-2ETH-XC

AC500-XC

Ordering data

Communication modules

Protocol	Connections	Type	Order code	Price	Weight (1 pce) kg
PROFIBUS DP V0/V1 master	D-Sub 9	CM592-DP-XC	1SAP373200R0001		0.115
PROFIBUS DP V0/V1 slave	D-Sub 9	CM582-DP-XC	1SAP372200R0001		0.115
Ethernet (TCP/IP, UDP/IP, Modbus TCP)	2 x RJ45 - integrated switch	CM597-ETH-XC	1SAP373700R0001		0.115
CANopen master	Terminal block 2 x 5 poles spring	CM598-CN-XC	1SAP373800R0001		0.115
CANopen slave	Terminal block 2 x 5 poles spring	CM588-CN-XC	1SAP372800R0001		0.115
PROFINET I/O RT controller	2 x RJ45 - integrated switch	CM579-PNIO-XC	1SAP370901R0101		0.115
PROFINET I/O RT device	2 x RJ45 - integrated switch	CM589-PNIO-XC	1SAP372900R0011		0.115
PROFINET IO RT with 4 devices	2xRJ45 - integrated switch	CM589-PNIO-4-XC	1SAP372900R0111		0.115



CM592-DP-XC



CM579-PNIO-XC

I/O modules

- For central expansion of the AC500-XC CPU
- For decentralized expansion in combination with communication interface module (not for DC505-FBP)
- DC: channels can be configured individually as inputs or outputs
- Terminal unit required (refer to table below).

Digital I/O

Number of	Input signal	Output type	Output signal	Terminal units	Type	Order code	Price	Weight (1 pce) kg
DI/DO/DC								
32 / - / -	24 V DC	-	-	TU516-XC	DI524-XC	1SAP440000R0001		0.200
- / - / 16	24 V DC	Transistor	24 V DC, 0.5 A	TU516-XC	DC522-XC	1SAP440600R0001		0.200
- / - / 24	24 V DC	Transistor	24 V DC, 0.5 A	TU516-XC	DC523-XC	1SAP440500R0001		0.200
16 / - / 16	24 V DC	Transistor	24 V DC, 0.5 A	TU516-XC	DC532-XC	1SAP440100R0001		0.200
- / 32 / -	24 V DC	Transistor	24 V DC, 0.5 A	TU516-XC	DO524-XC	1SAP440700R0001		0.200
8 / 8 / -	24 V DC	Relay	230 V AC, 3 A (1)	TU532-XC	DX522-XC	1SAP445200R0001		0.200
- / 8 / -	24 V DC	Transistor	24 V DC, 2 A (2)	TU542-XC	DO526-XC	1SAP440800R0001		0.200

(1) Relay outputs, changeover contacts.

(2) In preparation



DI524-XC



DO524-XC

AC500-XC

Ordering data

Analog I/O

Number of	Input signal	Output signal	Terminal units	Type	Order code	Price	Weight (1 pce) kg
AI/AO							
16 / 0	0...10 V, ±10 V 0/4...20 mA PT100, PT1000, Ni1000	–	TU516-XC	AI523-XC	1SAP450300R0001		0.200
4 / 4		±10 V	TU516-XC	AX521-XC	1SAP450100R0001		0.200
8 / 8 (max. 4 current outputs)		0/4...20 mA	TU516-XC	AX522-XC	1SAP450000R0001		0.200
0 / 16 (max. 8 current outputs)	–		TU516-XC	AO523-XC	1SAP450200R0001		0.200
8 / 0	0...5 V, 0...10 V, ±50 mV, ±500 mV, 1 V, ±5 V, ±10 V, 0/4...20 mA, ±20 mA PT100, PT1000, Ni1000, Cu50, 0...50 kΩ, S, T, N, K, J	–	TU516-XC	AI531-XC	1SAP450600R0001		0.200

Analog/digital mixed I/O

Standard I/O module with high functionality:

- 16 digital input channels
- 8 configurable In/Output channels
- First two inputs are also usable as high-speed counter (up to 50 kHz) together with AC500-XC CPU, CS31 or CI5xx-XC communication interface modules
- 4 independent analog input channels configurable for voltage, current, 12 bit + sign, 1-2 wire connection
- Galvanic isolation per module
- Usable with all CI5xx modules.

Number of	Input signal	Output type	Output signal	Terminal unit	Type	Order code	Price	Weight (1 pce) kg
AI/AO/DI/DO/DC								
4 / 2 / 16 / - / 8	24 V DC, 0...10 V, ±10 V, 0/4...20 mA, PT100, PT1000, Ni100, Ni1000	Transistor	24 V DC, 0.5 A ±10 V, 0/4...20 mA	TU516-XC	DA501-XC	1SAP450700R0001		0.200

Multifunctional modules

Functionality	Number of	Input signal	Output type	Output signal	Terminal unit	Type	Order code	Price	Weight (1 pce) kg
DI/DO/DC									
Encoder module									
Encoder and PWM module	2 / - / 8	24 V DC and 2 encoder inputs	2 PWM outputs	–	TU516-XC	CD522-XC	1SAP460300R0001		0.125

- DC541-XC occupies one communication module slot on the AC500-XC CPU terminal base, no terminal block required
- Usable with all CI5xx-XC modules.

Functionality	Number of	Input signal	Output type	Output signal	Terminal unit	Type	Order code	Price	Weight (1 pce) kg
DI/DO/DC									
Interrupt I/O and fast counter module									
Interrupt I/O and fast counter	- / - / 8	24 V DC	Transistor	24 V DC, 0.5 A	N/A (2)	DC541-CM-XC (1)	1SAP470000R0001		0.100

(1) Multifunctional module, refer to table on page 147 for details.

(2) Occupies a communication module slot.



AI523-XC



AI531-XC



DA501-XC



CD522-XC

AC500-XC

Ordering data

Communication interface modules

Number of	Input signal	Output type	Output signal	Terminal units	Type	Order code	Price	Weight (1 pce) kg
AI/AO/DI/DO/DC								
For CS31-Bus								
- / - / 8 / - / 16	24 V DC	Transistor	24 V DC, 0.5 A	TU552-CS31-XC	DC551-CS31-XC	1SAP420500R0001		0.200
- / - / - / - / 16	24 V DC	Transistor	24 V DC, 0.5 A	TU552-CS31-XC	CI590-CS31-HA-XC	1SAP421100R0001		0.200
4 / 2 / 8 / - / 8	24 V DC / 0...10 V, -10...+10 V, 0...20 mA, 4...20 mA, PT100, PT1000, Ni100, Ni1000	Transistor	24 V DC, 0.5 A / -10...+10 V, 0...20 mA, 4...20 mA	TU552-CS31-XC	CI592-CS31-XC	1SAP421200R0001		0.200
For PROFIBUS-DP								
4 / 2 / 8 / 8 / -	24 V DC / 0...10 V, -10...+10 V, 0...20 mA, 4...20 mA, PT100, PT1000, Ni100, Ni1000	Transistor	24 V DC, 0.5 A / -10...+10 V, 0...20 mA, 4...20 mA	TU510-XC / TU518-XC	CI541-DP-XC	1SAP424100R0001		0.200
- / - / 8 / 8 / 8	24 V DC	Transistor	24 V DC, 0.5 A	TU510-XC / TU518-XC	CI542-DP-XC	1SAP424200R0001		0.200
For CANopen								
4 / 2 / 8 / 8 / -	24 V DC / 0...10 V, -10...+10 V, 0...20 mA, 4...20 mA, PT100, PT1000, Ni100, Ni1000	Transistor	24 V DC, 0.5 A / -10...+10 V, 0...20 mA, 4...20 mA	TU510-XC / TU518-XC	CI581-CN-XC	1SAP428100R0001		0.200
- / - / 8 / 8 / 8	24 V DC	Transistor	24 V DC, 0.5 A	TU510-XC / TU518-XC	CI582-CN-XC	1SAP428200R0001		0.200
For Ethernet based protocol - PROFINET IO RT								
4 / 2 / 8 / 8 / -	24 V DC / 0...10 V, -10...+10 V, 0...20 mA, 4...20 mA, PT100, PT1000, Ni100, Ni1000	Transistor	24 V DC, 0.5 A / -10...+10 V, 0...20 mA, 4...20 mA	TU508-ETH-XC	CI501-PNIO-XC	1SAP420600R0001		0.200
- / - / 8 / 8 / 8	24 V DC	Transistor	24 V DC, 0.5 A	TU508-ETH-XC	CI502-PNIO-XC	1SAP420700R0001		0.200
For Ethernet based protocol - Modbus TCP								
4 / 2 / 8 / 8 / -	24 V DC / 0...10 V, -10...+10 V, 0...20 mA, 4...20 mA, PT100, PT1000, Ni100, Ni1000	Transistor	24 V DC, 0.5 A / -10...+10 V, 0...20 mA, 4...20 mA	TU508-ETH-XC	CI521-MODTCP-XC	1SAP422100R0001		0.200
- / - / 8 / 8 / 8	24 V DC	Transistor	24 V DC, 0.5 A	TU508-ETH-XC	CI522-MODTCP-XC	1SAP422200R0001		0.200

From	To	Output signal	Terminal units	Type	Order code	Price	Weight (1 pce) kg
Gateway for Ethernet based protocol - PROFINET IO RT							
PROFINET I/O	-	3 x RS232/485 ASCII serial interfaces	TU520-ETH-XC	CI504-PNIO-XC	1SAP421300R0001		0.200
PROFINET I/O	1 x CAN 2A/2B or CANopen Master	2 x RS232/485 ASCII serial interfaces	TU520-ETH-XC	CI506-PNIO-XC	1SAP421500R0001		0.200



DC551-CS31-XC



CI541-DP-XC



CI581-CN-XC



CI502-PNIO-XC



CI506-PNIO-XC

AC500-XC

Ordering data

Terminal units

For digital and analog expansion modules and interface modules. Please note: for modules with relay outputs, terminal units for 230 V AC (TU532-XC) is required.

For	Supply	Connection type	Type	Order code	Price	Weight (1 pce) kg
Ethernet interface modules	24 V DC	Spring	TU508-ETH-XC	1SAP414000R0001		0.300
CANopen/PROFIBUS DP interface modules	24 V DC	Spring	TU510-XC	1SAP410800R0001		0.300
I/O modules	24 V DC	Spring	TU516-XC	1SAP412000R0001		0.300
I/O modules - for Hot Swap (2)	24 V DC	Spring	TU516-H-XC	1SAP415000R0001		0.300
CANopen/PROFIBUS DP interface modules	24 V DC	Spring	TU518-XC (1)	1SAP411200R0001		0.300
Ethernet gateway modules	24 V DC	Spring	TU520-ETH-XC	1SAP414400R0001		0.300
I/O modules AC / Relay	230 V AC	Spring	TU532-XC	1SAP417000R0001		0.300
I/O modules AC / Relay - for Hot Swap (2)	230 V AC	Spring	TU532-H-XC	1SAP415100R0001		0.300
I/O module DO526-XC (2)	24 V DC	Spring	TU542-XC	1SAP413200R0001		0.300
I/O module DO526-XC - for Hot Swap(2)	24 V DC	Spring	TU542-H-XC	1SAP415200R0001		0.300
CS31 interface modules	24 V DC	Spring	TU552-CS31-XC	1SAP410400R0001		0.300

(1) TU518-XC Terminal units can also be used with PROFIBUS DP CI modules with baud rate up to 1Mbaud.

(2) in preparation

05



TU516-XC



TU520-ETH-XC



TU510-XC



TU508-ETH-XC

AC500-XC

Ordering data

Terminal units compatibility

Type	For I/O modules			For communication interface modules				
	TU516-XC	TU532-XC	TU542-XC	TU508-ETH-XC	TU510-XC	TU518-XC	TU520-ETH-XC	TU552-CS31-XC
	TU516-H-XC	TU532-H-XC	TU542-H-XC					
DA501-XC	•							
DC522-XC	•							
DC523-XC	•							
DC532-XC	•							
DI524-XC	•							
DO524-XC	•							
DO526-XC			•					
DX522-XC		•						
CD522-XC	•							
AI523-XC	•							
AI531-XC	•							
AO523-XC	•							
AX521-XC	•							
AX522-XC	•							
DC551-CS31-XC								•
CI590-CS31-HA-XC								•
CI592-CS31-XC								•
CI501-PNIO-XC				•				
CI502-PNIO-XC				•				
CI504-PNIO-XC							•	
CI506-PNIO-XC							•	
CI521-MODTCP-XC				•				
CI521-MODTCP-XC				•				
CI541-DP-XC					•	• (1)		
CI542-DP-XC					•	• (1)		
CI581-CN-XC						•		
CI582-CN-XC						•		

(1) Can be used with baudrate up to 1Mbaud.

AC500-XC

Ordering data

Accessories for AC500-XC

For	Description	Type	Order code	Price	Weight (1 pce) kg
AC500 CPUs COM1	Programming cable Sub-D / terminal block, length 5 m	TK502	1SAP180200R0101		0.400
AC500 CPUs COM2	Programming cable Sub-D / Sub-D, length 5 m	TK501	1SAP180200R0001		0.400
AC500 CPUs	Memory card (2 GB SD card)	MC502	1SAP180100R0001		0.020
	Lithium battery for data buffering	TA521	1SAP180300R0001		0.100
I/O modules	Pluggable marker holder for I/O modules, packing unit incl. 10 pcs. Template available in the AC500 online help	TA523	1SAP180500R0001		0.300
AC500 CPU's, interface module, communication module and I/O modules	White labels, packing unit incl. 10 pcs	TA525	1SAP180700R0001		0.100
Terminal base	Communication Module, blind cap	TA524	1SAP180600R0001		0.120
CPU terminal base	Accessories for mounting, packing unit includes 10 pcs	TA526	1SAP180800R0001		0.200
	5-pole power plug for AC500. Spare part. Can be plugged to CPU terminal base TB5x1. Packing unit includes 5 pcs	TA527	1SAP181100R0001		0.200
	9-pole COM1 plug for AC500. Spare part. Can be plugged to CPU terminal base TB5x1 or on TU520-ETH-XC. Packing unit includes 5 pcs	TA528	1SAP181200R0001		0.200
Communication modules	9-pole spring plug for CM574-RS/RCOM. Spare part. Packing includes 10 pcs	TA532	1SAP182000R0001		
	5-pole spring plug for CM575-DN/CM578-CN. Spare part. Packing includes 5 pcs	TA533	1SAP182100R0001		
	2x5-pole spring plug for CM588-CN and CM598-CN. Spare part. Packing includes 5 pcs.	TA534	1SAP182200R0001		
	10-pole spring plug for DC541-CM. Spare part. Packing includes 10 pcs.	TA536	1SAP183100R0001		
Protective caps for TB, TU and CM	10 x Sub-D plastic caps 20 x RJ45 plastic caps, 3 x RJ45 female 10 x M12 plastic caps	TA535	1SAP182300R0001		0.300
AC500 CPUs PM595	Protective cap, spare-parts, 3 pieces	TA540	1SAP182600R0001		0.200
	Lithium battery for real-time-clock buffering	TA541	1SAP182700R0001		0.030
	Accessories for screw-mounting, 20 pieces	TA543	1SAP182800R0001		0.100



MC502

AC500-XC

Technical data

AC500-XC CPUs

Type	PM573-ETH-XC	PM582-XC	PM583-ETH-XC
Supply voltage	24 V DC		
Current consumption on 24 V DC			
Min. (module alone)	0.110 A	0.050 A	0.110 A
Max. (all couplers and I/Os)	0.810 A	0.750 A	0.810 A
User program memory - Flash EPROM and RAM	512 kB	512 kB	1024 kB
Integrated user data memory	512 kB thereof 288 kB saved	416 kB thereof 288 kB saved	1024 kB thereof 288 kB saved
User Flashdisk (Data-storage, program access or also external with FTP)	-		
Plug-in memory card	depending on SD-Card used: no SD-HC card allowed, use MC502 accessory		
Web server's data for user RAM disk	1 024 kB	-	4 096 kB
Cycle time for 1 instruction (minimum)			
Binary	0.06 µs	0.05 µs	
Word	0.09 µs	0.06 µs	
Floating-point	0.7 µs	0.5 µs	
Max. number of centralized inputs/outputs			
Max. number of extension modules on I/O bus	up to max. 10 (S500 allowed)		
Digital	inputs / outputs 320 / 320		
Analog	inputs / outputs 160 / 160		
Max. number of decentralized inputs/outputs depends on the used standard Fieldbus (1)			
Data buffering	battery		
Real-time clock (with battery back-up)	●		
Program execution			
Cyclical / Time controlled / Multi tasking	● / ● / ●		
User program protection by password	●		
Internal interfaces			
COM1			
RS232 / RS485 configurable	●		
Connection (on terminal bases)	pluggable spring terminal block, use TK502 cable in accessory		
Programming, Modbus RTU, ASCII, CS31 master	●		
COM2			
RS232 / RS485 configurable	●		
Connection (on terminal bases)	D-Sub 9 female, use TK501 cable in accessory		
Programming, Modbus RTU, ASCII	●		
FieldBusPlug			
Serial neutral interface	●		
Connection (on terminal bases)	M12 male, 5 pole		
Functions	programming cable UTF-21-FBP, slave communication depending on FieldBusPlug used (PROFIBUS DP, CANopen, DeviceNet)		
Ethernet			
Ethernet connection (on terminal bases)	RJ45	-	RJ45
Ethernet functions: online Access, ICMP (Ping), DHCP, IP configuration protocol, UDP data exchange, Modbus TCP, HTTP (integrated Web server), IEC60870-5-104 remote control protocol, SNTP (Time synchronization), FTP server, SMTP client, Socket programming	●	-	●
Ethernet based Fieldbus			
Ethernet connection (on CPU module)	-		
Downloadable protocols like: PROFINET IO RT Controller / Device (2) EtherCAT Master	-		
LCD display and 8 function keys	●		
Function	RUN / STOP, status, diagnosis		
RUN / STOP, RESET push buttons	-		
LEDs for various status display	-		
Timers / Counters	unlimited / unlimited		
Approvals	See detailed page 220 or www.abb.com/plc		

(1) e.g. CS31 Fieldbus: up to 31 stations with up to 120 DI's / 120 DO's or up to 32 AI's / 32 AO's per station.

(2) Availability on demand

AC500-XC

Technical data

AC500-XC CPUs

Type	PM591-ETH-XC	PM592-ETH-XC	PM595-4ETH-M-XC
Supply voltage	24 V DC		
Current consumption on 24 V DC			
Min. (module alone)	0.150 A		0.400 A
Max. (all couplers and I/Os)	0.850 A		1.2 A
User program memory - Flash EPROM and RAM	4096 kB		16384 kB
Integrated user data memory	5632 kB thereof 1536 kB saved		16384 kB thereof 3072 kB saved
User Flashdisk (Data-storage, program access or also external with FTP)	-		Yes, 4 GB Flash non removable
Plug-in memory card	depending on SD-Card used: no SD-HC card allowed, use MC502 accessory		
Web server's data for user RAM disk	8 MB		32 MB
Cycle time for 1 instruction (minimum)			
Binary	0.002 µs		0.0006 µs
Word	0.004 µs		0.001 µs
Floating-point	0.004 µs		0.001 µs
Max. number of centralized inputs/outputs			
Max. number of extension modules on I/O bus	up to max. 10 (S500 allowed)		
Digital	inputs / outputs		320 / 320
Analog	inputs / outputs		160 / 160
Max. number of decentralized inputs/outputs			
depends on the used standard Fieldbus (1)			
Data buffering	battery		no battery needed
Real-time clock (with battery back-up)	●		
Program execution			
Cyclical / Time controlled / Multi tasking	● / ● / ●		
User program protection by password	●		
Internal interfaces			
COM1			
RS232 / RS485 configurable	●		
Connection (on terminal bases)	pluggable spring terminal block, use TK502 cable in accessory		
Programming, Modbus RTU, ASCII, CS31 master	●		
COM2			
RS232 / RS485 configurable	●		
Connection (on terminal bases)	SD-Sub 9 female, use TK501 cable in accessory		
Programming, Modbus RTU, ASCII	●		
FieldBusPlug			
Serial neutral interface	●		-
Connection (on terminal bases)	M12 male, 5 pole		-
Functions	programming cable UTF-21-FBP, slave communication depending on FieldBusPlug used (PROFIBUS DP, CANopen, DeviceNet)		-
Ethernet			
Ethernet connection (on terminal bases)	RJ45	RJ45	2x RJ45
Ethernet functions: online Access, ICMP (Ping), DHCP, IP configuration protocol, UDP data exchange, Modbus TCP, HTTP (integrated Web server), IEC60870-5-104 remote control protocol, SNTP (Time synchronization), FTP server, SMTP client, Socket programming	●	●	●
Ethernet based Fieldbus			
Ethernet connection (on CPU module)	-		4 x RJ45 (2x interfaces with 2-port switch)
Downloadable protocols like: PROFINET IO RT Controller / EtherCAT Master or Ethernet e.g. Modbus TCP client/server	-		●
LCD display and 8 function keys	●		-
Function	RUN / STOP, status, diagnosis		Status, diagnosis
RUN / STOP, RESET push buttons	-		●
LEDs for various status display	-		●
Timers / Counters	unlimited / unlimited		
Approvals	See detailed page 220 or www.abb.com/plc		

(1) e.g. CS31 Fieldbus: up to 31 stations with up to 120 DI/ 120 DOs or up to 32 AI/ 32 AO per station.

(2) Availability on demand

AC500-XC

Technical data

AC500-XC V3 CPUs

Type	PM5630-2ETH-XC	PM5650-2ETH-XC	PM5670-2ETH-XC	PM5675-2ETH-XC
Supply voltage	24 V DC			
Current consumption on 24 V DC				
Min. typ. (module alone)	0.150 A	0.200 A	0.250 A	0.250 A
Max. typ. (all couplers and I/Os)	0.850 A	0.900 A	0.950 A	0.950 A
User program memory / User Data memory	8 MB	80 MB	160 MB	160 MB
Web server's data – Flash EPROM and DRAM				
User data memory saved	256 KB	256 KB	1.5 MB	1.5 MB
User Flashdisk (Data-storage, programm access or also external with FTP)				8 GB Flash non removable
Plug-in memory card	Depending on SD-Card used : SD-HC card allowed, use MC502 preferably accessory			
Web server's data for user RAM disk	8 MB	No limitation, included into the global User Program/Data memory		
Cycle time for 1 instruction (minimum)				
Binary	0.02 µs	0.01 µs	0.002 µs	0.002 µs
Word	0.02 µs	0.01 µs	0.002 µs	0.002 µs
Floating-point	0.12 µs	0.01 µs	0.002 µs	0.002 µs
Communication modules supported				
Max. number of communication modules on TBs	up to 2	Up to 6 depending on available terminal bases (2)		
Type of communication module supported	CM579-PNIO-XC, CM589-PNIO-XC, CM582-DP (2), CM592-DP-XC (2), CM597-ETH-XC (2) and CM598-CN-XC (2)			
Max. number of centralized inputs/outputs				
Max. number of extension modules on I/O bus	up to max. 10 (S500 and/or S500-eCo modules allowed)			
Digital	inputs/outputs		320/320	
Analog	inputs/outputs		160/160	
Max. number of decentralized inputs/outputs				
depends on the used standard Fieldbus (1)				
Data buffering	battery			
Real-time clock (with battery back-up)	●			
Program execution				
Cyclical / Time controlled / multi tasking	●/●/●			
User program protection by password	●			
Internal interfaces				
COM1				
RS232 / RS485 configurable	●			
Connection (on terminal bases or CPU module)	pluggable spring terminal block, use TK502 cable in accessory			
Modbus RTU Master/Slave, ASCII	●			
CANopen				
Serial interface	CAN serial interface			
Connection (on terminal bases)	Pluggable spring terminal block, 2x 5 poles			
Functions	CANopen Master / Slave communication, CAN 2A/2B, J1939 protocol			
Ethernet				
Ethernet connection (on terminal bases)	2x independent Ethernet interfaces for several uses			
Ethernet connection (on terminal bases)	2x RJ45 with 2x separated interfaces and MAC-Address, could be used as 2-port switch with 1x interface			
Ethernet functions:				
Online Access, ICMP (Ping), DHCP	●			
IP configuration protocol	●			
UDP data exchange, Network variables	●			
Modbus TCP Client / Server	●			
IEC60870-5-104 remote control protocol	●			
HTTP / HTTPs (integrated Web server)	●			
SNTP (Time synchronization)	●			
FTP / FTPs server	●			
SMTP client	●			
Socket programming	●			
WebVisu for data visualisation on webserver HTML5	●			
OPC UA server (Micro Embedded Device Server) with security	●			
Ethernet Switch on ETH1 / ETH2	●			

(1) e.g. CANopen Fieldbus: up to 127 stations with up to 320 Digital channels or up to 160 Analog channels per station.

(2) Availability on demand

(3) Feature is licensed

AC500-XC

Technical data

AC500-XC V3 CPUs

Type	PM5630-2ETH-XC	PM5650-2ETH-XC	PM5670-2ETH-XC	PM5675-2ETH-XC
Ethernet based Fieldbus				
Downloadable protocols (licensed feature):	available on one Ethernet interface, the other interface can be sometimes used as switch			
IEC 61850 server	• (3)	• (3)	• (3)	• (3)
PROFINET IO RT Controller	• (2)(3)	• (2)(3)	• (2)	• (2)
EtherCAT Master	• (2)(3)	• (2)(3)	• (2)	• (2)
EthernetIP Adapter	• (2)(3)	• (2)(3)	• (2)(3)	• (2)(3)
LCD display	LCD display and 8 function keys			
Function	RUN / STOP, status, diagnosis			
LEDs for various status display	•			
Timer/Counter	unlimited/unlimited			
Approvals	See detailed page 220 or www.abb.com/plc			

(1) e.g. CANopen Fieldbus: up to 127 stations with up to 320 Digital channels or up to 160 Analog channels per station.

(2) Availability on demand

(3) Feature is licensed

AC500-XC

Technical data

Digital S500-XC I/O modules

Type	DI524-XC	DC522-XC	DC523-XC	DC532-XC	DO524-XC	DO526-XC	DX522-XC		
Number of channels per module									
Digital	inputs	32	–	–	16	–	–	8	
	outputs	–	–	–	–	32	8	8 relays	
Configurable channels DC (configurable as inputs or outputs)		–	16	24	16	–	–	–	
Additional configuration of channels as									
Fast counter		configuration of max. 2 channels per module, operating modes see table on page 161							
Occupies max. 1 DO or DC when used as counter		–	●	●	●	–	–	–	
Connection via terminal unit		●	●	●	●	●	●	●	
Digital inputs									
Input signal voltage		24 V DC				–	–	24 V DC	
Input characteristic acc. to EN 61132-2		Type 1				–	–	Type 1	
0 signal		-3...+5 V DC				–	–	-3...+5 V DC	
Undefined signal state		5...15 V DC				–	–	5...15 V DC	
1 signal		15...30 V DC				–	–	15...30 V DC	
Input time delay (0 -> 1 or 1 -> 0)		8 ms typically, configurable from 0.1 up to 32 ms				–	–	8 ms typically, configurable from 0.1 up to 32 ms	
Input current per channel									
At input voltage		24 V DC	5 mA typically		–	–	5 mA typically		
		5 V DC	> 1 mA		–	–	> 1 mA		
		15 V DC	> 5 mA		–	–	> 5 mA		
		30 V DC	< 8 mA		–	–	< 8 mA		
Digital outputs									
Transistor outputs 24 V DC		–	●	●	●	●	●	–	
Readback of output		–	●	●	●	–	–	–	
Relay outputs, supplied via process voltage UP, changeover contacts		–	–	–	–	–	–	●	
Switching of load		24 V	–	●	●	●	●	●	
		230 V	–	–	–	–	–	●	
Output voltage at signal state 1		–	process voltage UP minus 0.8 V				process voltage UP minus 0.4 V		–
Output current									
Nominal current per channel		–	500 mA at UP = 24 V				2 A at UP = 24 V	–	
Maximum (total current of all channels)		–	8 A				16 A	–	
Residual current at signal state 0		–	< 0.5 mA				–	–	
Demagnetization when switching off inductive loads		–	by internal varistors				–	–	
Switching frequency									
For inductive load		–	0.5 Hz max.			0.5 Hz max.		2 Hz	
For lamp load		–	11 Hz max. at max. 5 W				–	–	
Short-circuit / overload proofness		–	●	●	●	●	by external fuse / circuit breaker 6 A gL/gG per channel		
Overload indication (I > 0.7 A)		–	after approx. 100 ms				–	–	
Output current limiting		–	yes, with automatic reclosure				–	–	
Proofness against reverse feeding of 24 V signals		–	●	●	●	●	–	–	
Contact rating									
For resistive load, max.		–					3 A at 230 V AC 2 A at 24 V DC		
For inductive load, max.		–					1.5 A at 230 V AC 1.5 A at 24 V DC		
For lamp load		–					60 W at 230 V AC 10 W at 24 V DC		

AC500-XC

Technical data

Digital S500-XC I/O modules

Type	DI524-XC	DC522-XC	DC523-XC	DC532-XC	DO524-XC	DO526-XC	DX522-XC
Lifetime (switching cycles)							
Mechanical lifetime	-						300 000
Lifetime under load	-						300 000 at 24 V DC / 2 A 200 000 at 120 V AC / 2 A 100 000 at 230 V AC / 3 A
Spark suppression for inductive AC load	-						external measure depending on the switched load
Demagnetization for inductive DC load	-						external measure: free-wheeling diode connected in parallel to the load
Process voltage UP							
Nominal voltage	24 V DC						
Current consumption on UP							
Min. (module alone)	0.150 A	0.100 A	0.150 A	0.150 A	0.050 A	0.050 A	0.050 A
Max. (min. + loads)	0.150 A	0.100 A + load	0.150 A + load	0.150 A + load	0.100 A + load	0.050 A + load	0.050 A + load
Reverse polarity protection	●	●	●	●	●	●	●
Fuse for process voltage UP	10 A miniature fuse						
Connections for sensor voltage supply. Terminal 24 V and 0 V for each connection. Permitted load for each group of 4 or 8 connections: 0.5 A	-	8	4	-	-	-	-
Short-circuit and overload proof 24 V DC sensor supply voltage	-	●	●	-	-	-	-
Maximum cable length for connected process signals							
Cable	shielded	1000 m					
	unshielded	600 m					
Potential isolation							
Per module	●						
Between channels	input	-	-	-	-	-	-
	output	-	-	-	-	-	in groups of 4 ●
Voltage supply for the module	internally via extension bus interface (I/O bus)						
Fieldbus connection	via AC500-XC CPU or all communication interface modules (except DC505-FBP Fieldbus Plug module)						
Address setting	automatically (internal)						

AC500-XC

Technical data

Analog S500-XC I/O modules

Type	AX521-XC	AX522-XC	AI523-XC	AO523-XC	AI531-XC	
Number of channels per module						
Individual configuration, analog	inputs 4	8	16	–	8	
	outputs 4	8	–	16	–	
Signal resolution for channel configuration						
-10...+10 V	12 bits + sign				15 bits + sign	
0...10 V	12 bits				15 bits	
0...20 mA, 4...20 mA	12 bits				15 bits	
Temperature: 0.1 °C	•	•	•	–	•	
Monitoring configuration per channel						
Plausibility monitoring	•	•	•	•	•	
Wire break & short-circuit monitoring	•	•	•	•	•	
Analog Inputs AI						
Signal configuration per AI	max. number per module and with regard to the configuration: AIs / Measuring points (depending on the use of 2/3-wire connection or differential input)					
0...10 V	4 / 4	8 / 8	16 / 16	–	8 / 8	
-10...+10 V	4 / 4	8 / 8	16 / 16	–	8 / 8	
0...20 mA	4 / 4	8 / 8	16 / 16	–	8 / 8	
4...20 mA	4 / 4	8 / 8	16 / 16	–	8 / 8	
Pt100						
-50...+400 °C (2-wire)	4 / 4	8 / 8	16 / 16	–	8 / 8	
-50...+400 °C (3-wire), 2 channels	4 / 2	8 / 4	16 / 8	–	8 / 8	
-50...+400 °C (4-wire)	–	–	–	–	8 / 8	
-50...+70 °C (2-wire)	4 / 4	8 / 8	16 / 16	–	8 / 8	
-50...+70 °C (3-wire), 2 channels	4 / 2	8 / 4	16 / 8	–	8 / 8	
-50...+70 °C (4-wire)	–	–	–	–	8 / 8	
Pt1000						
-50...+400 °C (2-wire)	4 / 4	8 / 8	16 / 16	–	8 / 8	
-50...+400 °C (3-wire), 2 channels	4 / 2	8 / 4	16 / 8	–	8 / 8	
-50...+400 °C (4-wire)	–	–	–	–	8 / 8	
Ni1000						
-50...+150 °C (2-wire)	4 / 4	8 / 8	16 / 16	–	8 / 8	
-50...+150 °C (3-wire), 2 channels	4 / 2	8 / 4	16 / 8	–	8 / 8	
-50...+150 °C (4-wire)	–	–	–	–	8 / 8	
Thermocouples of types J, K, T, N, S	–	–	–	–	•	
0...10 V using differential inputs, 2 channels	4 / 2	8 / 4	16 / 8	–	8 / 8	
-10...+10 V using differential inputs, 2 channels	4 / 2	8 / 4	16 / 8	–	8 / 8	
Digital signals (digital input)	4 / 4	8 / 8	16 / 16	–	8 / 8	
Input resistance per channel	voltage: > 100 kΩ current: approx. 330 Ω			–	voltage: > 100 kΩ current: approx. 330 Ω	
Time constant of the input filter	voltage: 100 μs current: 100 μs			–	voltage: 100 μs current: 100 μs	
Conversion cycle	2 ms (for 8 AI + 8 AO), 1 s for Pt100/1000, Ni1000			–	1 ms (for 8 AI + 8 AO), 1 s for Pt100/1000, Ni1000	
Overvoltage protection	•	•	•	–	•	
Data when using the AI as digital input						
Input	time delay	8 ms typically, configurable from 0.1 up to 32 ms			–	8 ms typically, configurable from 0.1 up to 32 ms
	signal voltage	24 V DC			–	24 V DC
Signal	0	-30...+5 V			–	-30...+5 V
	1	13...30 V			–	13...30 V

(1) Half can be used on current (the other half remains available).

AC500-XC

Technical data

Analog S500-XC I/O modules

Type	AX521-XC	AX522-XC	AI523-XC	AO523-XC	AI531-XC
Analog outputs AO					
Possible configuration per AO	Max. number of AOs per module and with regard to the configuration:				
-10...+10 V	4	8 (1)	–	16 (1)	–
0...20 mA	4	–	–	8	–
4...20 mA	4	–	–	8	–
Output resistance (burden) when used as current output	0...500 Ω	–	–	0...500 Ω	–
loading capability when used as voltage output	Max. ±10 mA	–	–	Max. ±10 mA	–
Process voltage UP					
Nominal voltage	24 V DC				
Current consumption on UP					
Min. (module alone)	0.150 A	–	–	–	0.130 A
Max. (min. + loads)	0.150 A + load	0.150 A + load	–	0.150 A + load	–
Reverse polarity protection	•	•	•	•	•
Max. line length of the analog lines, conductor cross section > 0.14 mm ²	100 m				
Conversion error of analog values caused by non-linearity, calibration errors ex works and the resolution in the nominal range	0.5 % typically, 1 % max.				Voltage: 0.1 % typically, current/resistor 0.3 % typically
Potential isolation					
Per module	•	•	•	•	–
Fieldbus connection	Via AC500-XC CPU or all communication interface modules (except DC505-FBP)				
Voltage supply for the module	Internally via extension bus interface (I/O bus)				–

(1) Half can be used on current (the other half remains available).

AC500-XC

Technical data

CD522-XC encoder module

The CD522-XC module offers accuracy and dynamic flexibility for a customized solution. It has two independent encoder inputs onboard and is easily configured using the Automation Builder software for 10 different operation modes and for frequencies up to 300 kHz (depending on CPU cycle time). The CD522-XC module also integrates outputs for pulses and for PWM as well as normal inputs and outputs, depending on selected encoder mode.

Type		CD522-XC
Functionality		
Digital inputs/outputs		24 V DC, dedicated inputs/outputs can be used for specific counting functions. All unused inputs/outputs can be used as input/output with standard specification.
	Input options	Catch/Touch operation, counter value stored in separate variable on external event (rising or falling) Set to preset counter register with predefined value Set to reset counter register
	End value output	Output set when predefined value is reached
	Reference point initialization (RPI) input for relative encoder initialization	•
High-speed counter/encoder		
Integrated counters	Counter characteristics	2 counters (24 V DC, 5 V DC, differential and 1 Vpp sinus input)
	Counter mode	one 32 bits or two 16 bits
	Relative position encoder	X1, X2, X3
	Absolute SSI encoder	•
	Time frequency meter	•
	Frequency input	up to 300 kHz
PWM/pulse outputs		
Output mode specification	Number of outputs	2
	Push pull output	24 V DC, 100 mA max
	Current limitation	Thermal and overcurrent
PWM mode specification	Frequency	1...100 kHz
	Value	0...100 %
Pulse mode specification	Frequency	1...15 kHz
	Pulse emission	1...65535 pulses
	Number of pulses emitted indicator	0...100 %
Frequency mode specification	Frequency output	100 kHz
	Duty Cycle	Set to 50 %
Number of channels per module		
Digital	input	2
	output	2
Configurable channels DC (configurable as inputs or outputs)		8
Additional configuration of channels as		
Fast counter		Integrated 2 counter encoders
Connection via terminal unit		•
Digital Inputs		
Input	signal voltage	24 V DC
	time delay	8 ms typically configurable from 0.1 up to 32 ms
Input current per channel		
At input voltage	24 V DC	Typically 5 mA
	5 V DC	> 1 mA
	15 V DC	> 5 mA
	30 V DC	< 8 mA

AC500-XC

Technical data

CD522-XC encoder module

Type	CD522-XC	
Digital outputs		
Output voltage at signal state 1	UP – 0.8 V	
Output current		
Nominal current per channel	0.5 A at UP = 24 V	
Maximum (total current of all channels)	8 A	
Residual current at signal state 0	< 0.5 mA	
Demagnetization when switching off inductive loads	By internal varistors	
Switching frequency		
For inductive load	Max. 0.5 Hz	
For lamp load	Max. 11 Hz with max. 5 W	
Short-circuit / Overload proofness	●	
Overload indication (I > 0.7 A)	After approx. 100 ms	
Output current limiting	●	
Proofness against reverse feeding of 24 V signals	●	
Maximum cable length for connected process signals		
Cable	shielded	1000 m
	unshielded	600 m
Potential isolation		
Per module	●	
Technical data of the high-speed inputs		
Number of channels per module	6	
Input type	24 V DC, 5 V DC / Differential / Sinus 1 Vpp	
Frequency	300 kHz	
Technical data of the fast outputs		
Number of channels	2	
Indication of the output signals	Brightness of the LED depends on the number of pulses emitted (0 % to 100 %) (pulse output mode only)	
Output current		
Rated value, per channel	100 mA at UP = 24 V	
Maximum value (all channels together, configurable outputs included)	8 A	
Leakage current with signal 0	< 0.5 mA	
Rated protection fuse on UP	10 A fast	
De-magnetization when inductive loads are switched off	with varistors integrated in the module	
Overload message (I > 0.1 x A)	Yes, after ca. 100 ms	
Output current limitation	Yes, automatic reactivation after short-circuit/overload	
Resistance to feedback against 24 V signals	Yes	
Process voltage UP		
Nominal voltage	24 V DC	
Current consumption on UP		
Min. (module alone)	0.070 A	
Max. (min. + loads)	0.070 A + load	
Reverse polarity protection	●	
Fuse for process voltage UP	10 A miniature fuse	

AC500-XC

Technical data

Analog/digital mixed I/O expansion module

For all modules: max cable length for connected process signals is 1000 m for shielded cable and 600 m for unshielded ones. For all Input modules, the signal resolution for channel configuration is: -10...+10 V: 12 bit + sign; 0...10 V, 0...20 mA, 4...20 mA: 12 bits.

Type	DA501-XC	
Number of Channels per Module		
Digital	inputs	16
	outputs	–
Analog	inputs	4
	outputs	2
Digital configurable channels DC (configurable as inputs 8 or outputs)		
Additional configuration of channels as		
Fast counter		Yes
Occupies max. 1 DO or DC when used as counter		Configuration of max. 2 channels per module. Operating modes see table on page 161
Connection via terminal unit TU 5xx		•
Digital inputs		
Input	signal voltage	24 V DC
	characteristic acc. to EN 61132-2	Type 1
0 signal		-3...+5 V DC
Undefined signal state		5...15 V DC
1 signal		15...30 V DC
Residual ripple, range for	0 signal	-3...+5 V DC
	1 signal	15...30 V DC
Input time delay (0 -> 1 or 1 -> 0)		8 ms typically, configurable from 0.1 up to 32 ms
Digital outputs		
Transistor outputs 24 V DC, 0.5 A		•
Readback of output		•
Outputs, supplied via process voltage UP		•
Switching of 24 V load		•
Output voltage at signal state 1		Process voltage UP - 0.8 V
Output current		
Nominal current per channel		500 mA at UP = 24 V DC
Maximum (total current of all channels)		4 A
Residual current at signal state 0		< 0.5 mA
Demagnetization when switching off inductive loads		By internal varistors
Analog inputs AI		Max. number per module and with regard to the configuration: AIs / Measuring points
Signal configuration per AI		•
0...10 V / -10 ... +10 V		4 / 4
0...20 mA / 4...20 mA		4 / 4
RTD using 2/3 wire needs 1/2 channel(s)		4 / 2
0...10 V using differential inputs, needs 2 channels		4 / 2
-10...+10 V using differential inputs, needs 2 channels		4 / 2
Digital signals (digital input)		4 / 4
Data when using the AI as digital input		
Input	time delay	8 ms typically, configurable from 0.1 up to 32 ms
	signal voltage	24 V DC
Outputs, single configurable as		
Possible configuration per AO		•
-10...+10 V		•
0...20 mA / 4...20 mA		•
Output resistance (load) when used as current output		0...500 Ω
Output loading capability when used as voltage output		±10 mA max.
Potential isolation		
Per module		•

AC500-XC

Technical data

Analog/digital mixed I/O expansion module

Type	DA501-XC
Process voltage UP	
Nominal voltage	24 V DC
Current consumption on UP	
Min. (module alone)	0.070 A
Max. (min. + loads)	0.070 A + load
Reverse polarity protection	•
Fuse for process voltage UP	10 A miniature fuse
Approvals	See detailed page 220 or www.abb.com/plc

AC500-XC

Technical data

DC541-CM-XC interrupt I/O and fast counter module

In the operating mode counter, the channels can be configured as follows:

Input, Output, 32-bit up/down counter (uses C0...C3) as a 32-bit counter without limit, 32-bit periodic counter as a 32-bit counter with a limit, limiter for a 32-bit counter (limit channel 0), 32-bit up counter (forward counter) with the frequencies 50 kHz, 5 kHz and 2.5 kHz, pulse-width modulation (PWM) with a resolution of 10 kHz, time and frequency measurement, frequency output.

Type	DC541-CM-XC	
Number of channels per module		
Configurable channels DC (configurable as inputs or outputs)	8	
Additional configuration of channels as		
Fast counter	Yes	
Connection via CPU terminal base. Occupies one communication module slot	•	
Digital inputs		
Input signal voltage	24 V DC	
characteristic acc. to EN 61132-2	Type 1	
0 signal	-3...+5 V DC	
Undefined signal state	5...15 V DC	
1 signal	5...30 V DC	
Input time delay (0 -> 1 or 1 -> 0)	20 µs	
	Clamp to clamp - 300 µs with interrupt task	
Input current per channel		
At input voltage	24 V DC	5 mA typically
	5 V DC	> 1 mA
	15 V DC	> 5 mA
	30 V DC	< 8 mA
Digital outputs		
Transistor outputs 24 V DC, 0.5 A	•	
Readback of output	•	
Switching of 24 V load	•	
Output voltage at signal state 1	Process voltage UP minus 0.8 V	
Output current		
Nominal current per channel	500 mA at UP = 24 V	
Maximum (total current of all channels)	4 A	
Residual current at signal state 0	< 0.5 mA	
Demagnetization when switching off inductive loads	by internal varistors	
Potential isolation		
Per module	•	
Voltage supply for the module	Internally via backplane bus	

Interrupt I/O table

Configuration as	Configuration for channel no.					Max. no. of channels for this function	Remarks and notes regarding possible alternative combinations of the remaining channels (a and b)	
	Chan. 0	Chan. 1	Chan. 2	Chan. 3	Chan. 4-7			
Mode 1: Interrupt functionality								
Interrupt	Digital input	1	1	1	1	4	8	Each channel can be configured individually as interrupt input or output
	Digital output	1	1	1	1	4	8	
Mode 2: Counting functionality								
Digital I/Os	Digital input	1	1	1	1	4	8	Usual input
PWM (1)	Digital output	1	1	1	1	4	8	Usual output
	PWM, resolution 10 kHz	1	1	1	1	4	8	Outputs and pulsed signal with and adjustable on-off ratio

(1) Counter and fast counter data available on technical documentation.

AC500-XC

Technical data

AC500 Condition Monitoring CMS: FM502-CMS-XC

The FM502-CMS-XC function module offers precision and dynamic flexibility for customized solutions in condition monitoring, precise measurement or fast data logging applications. It has 16 fast, precise and synchronized analog inputs with 50k Samples/s (SPS), 24bit ADC resolution, completed with encoder inputs (incremental or absolute) with counter and additional DI and DC inputs/outputs on-board. It is easily configured using the Automation Builder software and the special libraries. Overall it has 12 different operation modes. One FM502 function module can be placed on the right side of PM592-ETH-XC CPU with a special function module terminal base TF5x1, to interface directly to the CPU. While long measurements can be flexibly configured, started and stopped, all inputs are available in the I/O Image of CPU for immediate use (measurement, protection, control, ...)

Type	FM502-CMS-XC	
Data storage		
Fast user data memory of FM502	128 MB (ca. 33 million Samples: e.g 40 s record length on 16 channels at 50k SPS or 5.8 h record length on 16 channels at 100 SPS)	
File Format delivered to PM592 flash	WAV (compact binary) per channel, all channels in one *.zip w. time stamp	
Analog inputs		
Number of channels	16 (synchronous sampled)	
Resolution	24 bit ADC, stored in DINT in WAV file (4byte per value)	
Accuracy at +25 °C	< +/- 0.1 %	
Accuracy over operating temperature and vibration	< +/- 0.5 %	
Sample rate / Bandwidth (High, 0 dB)	50k SPS / 20 kHz to 100 SPS / 40 Hz (digitally downsampled, selectable per channel)	
Indication of the input signal	One bicolor LED per channel for configuration, measurement status, error messages	
Input option:	IEPE (with Sensor supply current)	+ - 10V
Bandwidth low (- 3 dB)	digital < 0.1 Hz	digital < 0.1 Hz or DC (selectable)
Pass band high (- 3 dB)	analog > 90 kHz, digital > 24.5 kHz	
Stop band high (> - 100 dB)	analog > 1 MHz, digital > 27.5 kHz	
Dynamic Range (SFDR)	> 100 dB	
SINAD (300 Hz/1 kHz sine, 50 k SPS) 0dB from full scale	< -90 dB	< - 95 dB
IEPE Current Source per channel	Typ. 4.2 mA (+/- 7% over temperature)	(n.a.)
Resistance AI- to M (ground)	Typ ~ 270hm (PTC)	
Channel input impedance (AI+/AI-):		
< 1 kHz	> 1 MOhm	> 2 MOhm
5 kHz	> 100 kOhm	> 40 kOhm
10 kHz	> 60 kOhm	> 25 kOhm
20 kHz	> 40 kOhm	> 8 kOhm
Error detection	Short circuit, open wire	
Max. cable length, shielded (depending on sensor)	100 m	
Digital inputs/outputs		
	24 V DC, dedicated inputs/outputs can be used for specific counting functions.	
	All unused inputs/outputs can be used as normal input/output with standard specification.	
Channels and types	2 DI + 2 DC (configurable inputs/outputs); Type 1, LED indication	
Input options	Catch/Touch operation, counter value stored in separate variable on external event (rising or falling)	
	Set to preset counter register with predefined value	
	Set to reset counter register	
End value output	Output set when predefined value is reached	
Reference point initialization (RPI) input for relative encoder initialization	•	
Input current p. channel @ V DC		
24 V DC	Typically 5 mA	
5 V DC	> 1 mA	
15 V DC	> 5 mA	
30 V DC	< 8 mA	

AC500-XC

Technical data

AC500 Condition Monitoring CMS: FM502-CMS-XC

Type	FM502-CMS-XC
Digital outputs	
Output voltage at signal state 1	(L+) – 0.8 V
Output current	
Nominal current per channel	0.5 A at UP = 24 V
Residual current at signal state 0	< 0.5 mA
Demagnetization when switching off inductive loads	By internal varistors
Switching frequency	
For inductive load	Max. 0.5 Hz
For lamp load	Max. 11 Hz with max. 5 W
Short-circuit / Overload proofness	•
Overload indication (I > 0.7 A)	After approx. 100 ms
Output current limiting	•
Resistance against reverse feeding of 24 V signals	•
Maximum cable length for connected process signals	
shielded	1000 m
unshielded	600 m
High-speed counter/encoder	
Integrated counters	
Counter characteristics	2 counters (24 V DC, 5 V DC, differential RS422: 5 V or 1 Vpp sinus input)
Counter mode	one counter 32 bits or two counters 16 bits
Relative position encoder	X1, X2, X3
Absolute SSI encoder	•
Time frequency meter	•
Frequency input	up to 300 kHz
Additional configuration of channels as	
Fast counter	Integrated 2 counter encoders
high-speed inputs	
Number of channels, type per module	3 (A,B,Z), type 1
Input type	24 V DC 5 V DC / Differential / Sinus 1 Vpp
Frequency	up to 300 kHz (input filter: 50,500, 5 k, 20 k Hz)
Input frequency max. (frequency measurement only)	100 kHz (accuracy -0 %/+3 %)
Max. cable length, shielded (depending on sensor)	300 m 100 m
Fast outputs	
SSI CLK output B	f. optical Interface (according SSI): Pin 1.3 RS-422 differential (according SSI) Pins 1.3, 1.4
Output delay (0->1 or 1->0)	Max. 0.35 µs
Output current	≤ 10 mA
Switching frequency (selectable)	200kHz, 500kHz and 1 MHz
Short-circuit proof / overload proof	Yes
Output current limitation	Yes, automatic reactivation after short-circuit/overload
Resistance to feedback against 24V signals	Yes
Resistance to feedback against reverse polarity	Yes
Max. cable length, shielded (depending on sensor)	100 m
Process voltage L+	
Nominal voltage	24 V DC
Max. ripple	0,05
Current consumption from L+ (FM502 and PM592, no communication module)	Max. 0.43 A + max. 0.5 A per output
Inrush current from L+ (at power up, FM502 and PM592, no communication module)	1.2 A ² s
Electrical isolation	Yes, (PM592 and FM502 to other I/O-Bus modules)
Max. power dissipation within the FM502 module	6.5 W (outputs unloaded)
5-V-encoder supply output	
Nominal voltage	5 V DC (+/- 5%), 100 mA max.

(1) High Temperatures:

Operation of FM502-XC version in the operating temperature range between +60 °C and +70 °C with following deratings:

No use of 24 V encoder mode

Analog inputs: maximum number of configured input channels limited to 75 % per group AI0..AI7 and AI8..AI15

AC500-XC

Technical data

AC500-XC communication modules

- Up to 4 communications modules can be used on an AC500-XC CPU
- No external power supply required.

Type	CM592-DP-XC	CM582-DP-XC	CM597-ETH-XC	CM598-CN-XC
Communication interfaces				
RJ45	-	-	● (x2) (2)	-
RS-232 / 485	-	-	-	-
Terminal blocks (1)	-	-	-	●
Sub-D socket	●	●	-	-
Protocols	PROFIBUS DP V0/V1 master	PROFIBUS DP V0/V1 slave	Ethernet (TCP/IP, UDP/IP, Modbus TCP)	CANopen master
CPU interface	8 kB Dual-port memory	8 kB Dual-port memory	8 kB Dual-port memory	8 kB Dual-port memory
Transfer Rate	9.6 kbit/s to 12 Mbit/s	9.6 kbit/s to 12 Mbit/s	10/100 Mbit/s	10 kbit/s to 1 Mbit/s
Co-processor	Communication processor netX 100	Communication processor netX 100	Communication processor netX 100	Communication processor netX 100
Additional features	Multi master functionality Max. Number of subscribers: - 126 (V0) - 32 (V1)	-	Online Access, ICMP (Pimg), DHCP, IP configuration protocol, UDP dataexchange, Modbus TCP	CAN 2.0A CAN 2.0B CANopen

Type	CM588-CN-XC	CM579-PNIO-XC	CM589-PNIO-XC	CM589-PNIO-4-XC
Communication interfaces				
RJ45	-	● (x2) (2)	● (x2) (2)	● (x2) (2)
RS-232 / 485	-	-	-	-
Terminal blocks (1)	●	-	-	-
Sub-D socket	-	-	-	-
Protocols	CANopen slave	PROFINET IO controller	PROFINET IO device	PROFINET IO 4 x device
CPU interface	8 kB Dual-port memory	8 kB Dual-port memory	8 kB Dual-port memory	8 kB Dual-port memory
Transfer Rate	10 kbit/s to 1 Mbit/s	10/100 Mbit/s	10/100 Mbit/s	10/100 Mbit/s
Co-processor	Communication processor netX 100	Communication processor netX 100	Communication processor netX 100	Communication processor netX 100
Additional features	NMT slave, PDO, SDO server, Heartbeat, Nodeguard	RTC - Real-Time Cyclic protocol, Class 1 RTA - Real-Time Acyclic protocol DCP Discovery and Configuration Protocol CL-RPC - Connectionless Remote Procedure Call	RTC - Real-Time Cyclic protocol, Class 1 RTA - Real-Time Acyclic protocol DCP Discovery and Configuration Protocol LLDP - Link Layer Discovery Protocol	RTC - Real-Time Cyclic protocol, Class 1 RTA - Real-Time Acyclic protocol DCP Discovery and Configuration Protocol LLDP - Link Layer Discovery Protocol

(1) Plug-in terminal block included.

(2) 10/100 Mbit/s, full/half duplex with auto-sensing, 2-port switch integrated.

AC500-XC

Technical data

Communication interface modules

For all modules: max cable length for connected process signals is 1000 m for shielded cable and 600 m for unshielded ones. For all Input modules, the signal resolution for channel configuration is: -10...+10 V: 12 bits + sign; 0...10 V, 0...20 mA, 4...20 mA: 12 bits. Temperature: 0.1 °C.

Type		DC551-CS31-XC	CI590-CS31-HA-XC (1)	CI592-CS31-XC
Communication Interface				
Protocol		Proprietary CS31 bus protocol on RS485 interface		
ID configuration		Per rotary switches on front face from 00d to 99d		
Field bus connection on TUs		CS31 field bus, via terminal / redundant for CI590-CS31-HA-XC on TU552-CS31-XC		
Number of Channels per Module				
Digital	inputs	8	–	8
	outputs	–	–	–
Analog	inputs	–	–	4
	outputs	–	–	2
Digital configurable channels DC (configurable as inputs or outputs)		16	16	8
Additional configuration of channels as				
Fast counter		Configuration of max. 2 channels per module		
Occupies max. 1 DO or DC when used as counter		•	•	•
Connection				
Via terminal base TU5xx		•	•	•
Local I/O extension				
Max. number of extension modules		max. 7 x S500 extension modules, up to 31 stations with up to 120 DI/120 DOs or up to 32 AIs/ 32AOs per station		
Digital inputs				
Input	signal voltage	24 V DC		
	characteristic acc. to EN 61132-2	Type 1		
0 signal		-3...+5 V DC		
Undefined signal state		5...15 V DC		
1 signal		15...30 V DC		
Residual ripple, range for	0 signal	-3...+5 V DC		
	1 signal	15...30 V DC		
Input time delay (0 -> 1 or 1 -> 0)		8 ms typically, configurable from 0.1 up to 32 ms		
Digital outputs				
Transistor outputs 24 V DC, 0.5 A		•		
Readback of output		•		
Outputs, supplied via process voltage UP		•		
Switching of 24 V load		•		
Output voltage at signal state 1		Process voltage UP - 0.8 V		
Output current				
Nominal current per channel		500 mA at UP = 24 V DC		
Maximum (total current of all channels)		8 A	8 A	4 A
Residual current at signal state 0		< 0.5 mA		
Demagnetization when switching off inductive loads		By internal varistors		
Analog inputs AI				
Signal configuration per AI		–		•
0...10 V / -10...+10 V		–		4 / 4
0...20 mA / 4...20 mA		–		4 / 4
RTD using 2/3 wire needs 1/2 channel(s)		–		4 / 2
0...10 V using differential inputs, needs 2 channels		–		4 / 2
-10...+10 V using differential inputs, needs 2 channels		–		4 / 2
Digital signals (digital input)		–		4 / 4

(1) Dedicated to High Availability. Not compatible with S500-eCo I/O modules.

AC500-XC

Technical data

Communication interface modules

Type	DC551-CS31-XC	CI590-CS31-HA-XC (1)	CI592-CS31-XC
Data when using the AI as digital input			
Input			
time delay	-		8 ms typically, configurable from 0.1 up to 32 ms
signal voltage	-		24 V DC
Outputs, single configurable as			
Possible configuration per AO	-		●
-10...+10 V	-		●
0...20 mA / 4...20 mA	-		●
Output			
resistance (load) when used as current output	-		0...500 Ω
loading capability when used as voltage output	-		±10 mA max.
Potential isolation			
Per module	●	●	●
Between fieldbus interface against the rest of the module	●	●	●
Voltage supply for the module	By external 24 V DC voltage via terminal UP		
Process voltage UP			
Nominal voltage	24 V DC		
Current consumption on UP			
Min. (module alone)	0.100 A	0.100 A	0.070 A
Max. (min. + loads)	0.100 A + load	0.100 A + load	0.070 A + load
Reverse polarity protection	●		
Fuse for process voltage UP	10 A miniature fuse		
Approvals	See detailed page 220 or www.abb.com/plc		

(1) Dedicated to High Availability. Not compatible with S500-eCo I/O modules.

AC500-XC

Technical data

PROFIBUS-DP modules

Type	CI541-DP-XC	CI542-DP-XC	
Communication Interface			
Protocol	PROFIBUS DP (DP-V0 and DP-V1 slave)		
ID configuration	Per rotary switches on front face from 00h to FFh		
Field bus connection on terminal units	Sub-D 9 poles on TU510-XC or TU518-XC with baud rate up to 1MBaud		
Number of Channels per Module			
Digital	inputs	8	8
	outputs	8	8
Analog	inputs	4	–
	outputs	2	–
Digital configurable channels DC (configurable as inputs or outputs)	–	–	8
Additional configuration of channels as			
Fast counter (onboard I/O)	Configuration of max. 2 DI channels per module		
Occupies max 1 DO or DC when used as counter	•	•	
Connection			
Local I/O extension	•		
Max. number of extension modules	max. 10 x S500 extension modules, fast counter from digital IO modules can be also used		
Via terminal base TU5xx	•	•	
Digital inputs			
Input	signal voltage	24 V DC	
	characteristic acc. to EN 61132-2	Type 1	
0 signal	–3...+5 V DC		
Undefined signal state	5...15 V DC		
1 signal	15...30 V DC		
Residual ripple, range for	0 signal	–3...+5 V DC	
	1 signal	15...30 V DC	
Input time delay (0 -> 1 or 1 -> 0)	8 ms typically, configurable from 0.1 up to 32 ms		
Digital outputs			
Transistor outputs 24 V DC, 0.5 A	•		
Readback of output	–	• (on DC outputs)	
Outputs, supplied via process voltage UP	•		
Switching of 24 V load	•		
Output voltage at signal state 1	Process voltage UP - 0.8 V		
Output current			
Nominal current per channel	500 mA at UP = 24 V DC		
Maximum (total current of all channels)	8 A		
Residual current at signal state 0	< 0.5 mA		
Demagnetization when switching off inductive loads	By internal varistors		
Analog Inputs AI			
	Max. number per module and with regard to the configuration: AIs / Measuring points		
Signal configuration per AI	4	–	
0...10 V / -10...+10 V	4 / 4	–	
0...20 mA / 4...20 mA	4 / 4	–	
RTD using 2/3 wire needs 1/2 channel(s)	4 / 2	–	
0...10 V using differential inputs, needs 2 channels	4 / 2	–	
-10...+10 V using differential inputs, needs 2 channels	4 / 2	–	
Digital signals (digital input)	4 / 4	–	
Data when using the AI as digital input			
Input	time delay	8 ms typically, configurable from 0.1 up to 32 ms	–
	signal voltage	24 V DC	–

AC500-XC

Technical data

PROFIBUS-DP modules

Type	CI541-DP-XC	CI542-DP-XC
Outputs, single configurable as		
Possible configuration per AO	•	–
-10...+10V	•	–
0...20 mA / 4...20 mA	•	–
Output resistance (load) when used as current output	0...500 Ω	–
loading capability when used as voltage output	±10 mA max.	–
Potential isolation		
Per module	•	•
Between fieldbus interface against the rest of the module	•	•
Between the channels		
input	–	–
output	–	–
Voltage supply for the module	By external 24 V DC voltage via terminal UP	
Process voltage UP		
Nominal voltage	24 V DC	
Current consumption on UP		
Min. (module alone)	0.260 A	
Max. (min. + loads)	0.260 A + load	
Reverse polarity protection	•	
Fuse for process voltage UP	10 A miniature fuse	
Approvals	See detailed page 220 or www.abb.com/plc	

AC500-XC

Technical data

CANopen modules

Type	CI581-CN-XC	CI582-CN-XC
Communication interface		
Protocol	CANopen slave, DS401 profile selectable using rotary switches	
ID configuration	Per rotary switches on front face for CANopen ID node from 00h to 7Fh and 80h to FFh for CANopen DS401 profile	
Field bus connection on terminal units	Terminal blocks on TU518-XC	
Number of channels per module		
Digital	inputs	8
	outputs	8
Analog	inputs	–
	outputs	–
Digital configurable channels DC (configurable as inputs or outputs)	–	8
Additional configuration of channels as		
Fast counter (onboard I/O)	Configuration of max. 2 DI channels per module	
Occupies max. 1 DO or DC when used as counter	●	●
Connection		
Local I/O extension	●	
Max. number of extension modules	max. 10 x S500-XC extension modules	
Via terminal unit TU5xx	●	●
Digital inputs		
Input	signal voltage	24 V DC
	characteristic acc. to EN 61132-2	Type 1
0 signal		-3...+5 V DC
Undefined signal state		5...15 V DC
1 signal		15...30 V DC
Residual ripple, range for	0 signal	-3...+5 V DC
	1 signal	15...30 V DC
Input time delay (0 -> 1 or 1 -> 0)	8 ms typically, configurable from 0.1 up to 32 ms	
Digital outputs		
Transistor outputs 24 V DC, 0.5 A	●	
Readback of output	–	● (on DC outputs)
Outputs, supplied via process voltage UP	●	
Switching of 24 V load	●	
Output voltage at signal state 1	Process voltage UP - 0.8 V	
Output current		
Nominal current per channel	500 mA at UP = 24 V DC	
Maximum (total current of all channels)	8 A	
Residual current at signal state 0	< 0.5 mA	
Demagnetization when switching off inductive loads	By internal varistors	
Analog Inputs AI		
Max. number per module and with regard to the configuration: AIs / Measuring points		
Signal configuration per AI	4	–
0...10 V / -10...+10 V	4 / 4	–
0...20 mA / 4...20 mA	4 / 4	–
RTD using 2/3 wire needs 1/2 channel(s)	4 / 2	–
0...10 V using differential inputs, needs 2 channels	4 / 2	–
-10...+10 V using differential inputs, needs 2 channels	4 / 2	–
Digital signals (digital input)	4 / 4	–
Data when using the AI as digital input		
Input	time delay	8 ms typically, configurable from 0.1 up to 32 ms
	signal voltage	24 V DC

AC500-XC

Technical data

CANopen modules

Type	CI581-CN-XC	CI582-CN-XC
Outputs, single configurable as		
Possible configuration per AO	•	–
-10...+10 V	•	–
0...20 mA / 4...20 mA	•	–
Output	resistance (load) when used as current output	0...500 Ω
	loading capability when used as voltage output	±10 mA max.
Potential isolation		
Per module	•	•
Between fieldbus interface against the rest of the module	•	•
Between the channels	input	–
	output	–
Voltage supply for the module	By external 24 V DC voltage via terminal UP	
Process voltage UP		
Nominal voltage	24 V DC	
Current consumption on UP		
	Min. (module alone)	0.260 A
	Max. (min. + loads)	0.260 A + load
Reverse polarity protection	•	
Fuse for process voltage UP	10 A miniature fuse	
Approvals	See detailed page 220 or www.abb.com/plc	

AC500-XC

Technical data

PROFINET IO RT device modules

Type	CI501-PNIO-XC	CI502-PNIO-XC	CI504-PNIO-XC	CI506-PNIO-XC
Communication interface				
Ethernet Interface				
Main protocol	PROFINET IO RT device			
ID Device configuration	By rotary switch on the front side, from 00h to FFh			
Ethernet connection on terminal units	2 x RJ45 with switch functionality for simple daisy chain on TU508-ETH-XC or TU520-ETH-XC			
Gateway Interface				
Gateway to	-	-	3 x RS232/RS422/ RS485 ASCII serial interfaces	CAN / CANopen Master + 2 x RS232/RS422/ RS485 ASCII serial interfaces
Fieldbus Protocol used				
CAN physical interface	-	-	-	CAN 2A/2B Master - CANopen Master (1)
Baudrate	-	-	-	Baudrate up to 1 MBit/s, Support for up to 126 CANopen Slaves
Serial interface				
Protocol used	-	-	3 x RS232 / RS422 or RS485	2 x RS232 / RS422 or RS485
Baudrate	-	-	Configurable from 300 bit/s to 115200 bit/s	
Fieldbus or serial connection on TUs	-	-	3 x pluggable terminal blocks with spring on TU520-ETH	
Number of channels per module				
Digital	inputs	8	8	-
	outputs	8	8	-
Analog	inputs	4	-	-
	outputs	2	-	-
Digital configurable channels DC (configurable as inputs or outputs)		-	8	-
Additional configuration of channels as				
Connection via terminal unit TU5xx		-	-	●
Fast counter (onboard I/O)		Configuration of max. 2 DI channels per module		-
Occupies max. 1 DO or DC when used as counter		●	-	-
Connection				
Local I/O extension		●	-	●
Max. number of extension modules		max. 10 x S500-XC extension modules. Fast counter from digital IO modules can be also used.		Valid for CI501-XC, 502-XC, 504-XC and 506-XC. All modules can have extension up to 10 modules
Digital inputs				
Input	signal voltage	24 V DC		-
	characteristic acc. to EN 61132-2	Type 1		-
0 signal		-3...+5 V DC		-
Undefined signal state		5...15 V DC		-
1 signal		15...30 V DC		-
Residual ripple, range for	0 signal	-3...+5 V DC		-
	1 signal	15...30 V DC		-
Input time delay (0 -> 1 or 1 -> 0)		8 ms typically, configurable from 0.1 up to 32 ms		-
Digital outputs				
Transistor outputs 24 V DC, 0.5 A		●	-	-
Readback of output		-	● (on DC outputs)	-
Outputs, supplied via process voltage UP		●	-	-
Switching of 24 V load		●	-	-
Output voltage at signal state 1		Process voltage UP - 0.8 V		-

(1) Not simultaneously.

AC500-XC

Technical data

PROFINET IO RT device modules

Type	CI501-PNIO-XC	CI502-PNIO-XC	CI504-PNIO-XC	CI506-PNIO-XC
Output current				
Nominal current per channel	500 mA at UP = 24 V DC		-	-
Maximum (total current of all channels)	8 A		-	-
Residual current at signal state 0	< 0.5 mA		-	-
Demagnetization when switching off inductive loads	By internal varistors		-	-
Analog inputs AI				
	Max. number per module and with regard to the configuration: AIs / Measuring points			
Signal configuration per AI	4	-	-	-
0...10 V / -10... +10 V	4 / 4	-	-	-
0...20 mA / 4...20 mA	4 / 4	-	-	-
RTD using 2/3 wire needs 1/2 channel(s)	4 / 2	-	-	-
0...10 V using differential inputs, needs 2 channels	4 / 2	-	-	-
-10...+10 V using differential inputs, needs 2 channels	4 / 2	-	-	-
Digital signals (digital input)	4 / 4	-	-	-
Data when using the AI as digital input				
Input	time delay	8 ms typically, configurable from 0.1 up to 32 ms	-	-
	signal voltage	24 V DC	-	-
Outputs, single configurable as				
Possible configuration per AO		●	-	-
-10...+10 V		●	-	-
0...20 mA / 4...20 mA		●	-	-
Output	resistance (load) when used as current output	0...500 Ω	-	-
	loading capability when used as voltage output	±10 mA max.	-	-
Potential isolation				
Per module		●	●	●
Between Ethernet interface against the rest of the module		●	●	●
Voltage supply for the module		By external 24 V DC voltage via terminal UP		
Process voltage UP				
Nominal voltage		24 V DC		
Current consumption on UP				
min. (module alone)		0.260 A		0.150 A
max. (min. + loads)		0.260 A + load		0.150 A + load
Reverse polarity protection		●		
Fuse for process voltage UP		10 A miniature fuse		
Approvals		See detailed page 220 or www.abb.com/plc		

(1) Not simultaneously.

AC500-XC

Technical data

Modbus TCP modules

Type	CI521-MODTCP-XC	CI522-MODTCP-XC	
Communication interface			
Ethernet Interface			
Main protocol	Modbus TCP		
ID Device configuration	By rotary switch on the front side, from 00h to FFh		
Ethernet connection on terminal units	2 x RJ45 with switch functionality for simple daisy chain on TU508-ETH-XC or TU520-ETH-XC		
Number of channels per module			
Digital	inputs	8	8
	outputs	8	8
Analog	inputs	4	–
	outputs	2	–
Digital configurable channels DC (configurable as inputs or outputs)		–	8
Additional configuration of channels as			
Connection via terminal unit TU5xx	–	–	
Fast counter (onboard I/O)	Configuration of max. 2 DI channels per module		
Occupies max. 1 DO or DC when used as counter	●		
Connection			
Local I/O extension	●		
Max. number of extension modules	max. 10 x S500-XC extension modules. Fast counter from digital IO modules can be also used.		
Digital inputs			
Input	signal voltage	24 V DC	
	characteristic acc. to EN 61132-2	Type 1	
0 signal	–3...+5 V DC		
Undefined signal state	5...15 V DC		
1 signal	15...30 V DC		
Residual ripple, range for	0 signal	–3...+5 V DC	
	1 signal	15...30 V DC	
Input time delay (0 -> 1 or 1 -> 0)	8 ms typically, configurable from 0.1 up to 32 ms		
Digital outputs			
Transistor outputs 24 V DC, 0.5 A	●		
Readback of output	–	● (on DC outputs)	
Outputs, supplied via process voltage UP	●		
Switching of 24 V load	●		
Output voltage at signal state 1	Process voltage UP - 0.8 V		
Output current			
Nominal current per channel	500 mA at UP = 24 V DC		
Maximum (total current of all channels)	8 A		
Residual current at signal state 0	< 0.5 mA		
Demagnetization when switching off inductive loads	By internal varistors		
Analog inputs AI			
Max. number per module and with regard to the configuration: AIs / Measuring points			
Signal configuration per AI	4	–	
0...10 V / –10... +10 V	4 / 4	–	
0...20 mA / 4...20 mA	4 / 4	–	
RTD using 2/3 wire needs 1/2 channel(s)	4 / 2	–	
0...10 V using differential inputs, needs 2 channels	4 / 2	–	
–10...+10 V using differential inputs, needs 2 channels	4 / 2	–	
Digital signals (digital input)	4 / 4	–	

(1) Not simultaneously.

AC500-XC

Technical data

Modbus TCP modules

Type	CI521-MODTCP-XC	CI522-MODTCP-XC	
Data when using the AI as digital input			
Input	time delay	8 ms typically, configurable from 0.1 up to 32 ms	–
	signal voltage	24 V DC	–
Outputs, single configurable as			
Possible configuration per AO		•	–
-10...+10 V		•	–
0...20 mA / 4...20 mA		•	–
Output	resistance (load) when used as current output	0...500 Ω	–
	loading capability when used as voltage output	±10 mA max.	–
Potential isolation			
Per module		•	•
Between Ethernet interface against the rest of the module		•	•
Voltage supply for the module		By external 24 V DC voltage via terminal UP	
Process voltage UP			
Nominal voltage		24 V DC	
Current consumption on UP			
min. (module alone)		0.260 A	
max. (min. + loads)		0.260 A + load	
Reverse polarity protection		•	
Fuse for process voltage UP		10 A miniature fuse	
Approvals		See detailed page 220 or www.abb.com/plc	

(1) Not simultaneously.

AC500-XC

Technical data

CS31 functionality

	AC500-XC CPU with integrated CS31 interface	S500 I/O with communication interface DC551-CS31-XC CI590-CS31-HA-XC CI592-CS31-XC
Master	Yes, at COM1	–
Slave	No	Yes / Redundant for CI590-CS31-HA-XC
Protocols supported	ABB CS31 protocol	
Diagnosis		
Error indication	On LCD display of the CPU	Via module LEDs
Online diagnosis	Yes	
Error code	Errors are recorded in the diagnosis system of the CPU	
Associated function blocks	Yes	
Physical layer		
Connection	RS485 / 2 x RS485 for CI590-CS31-HA-XC for redundancy	Screw-type or spring-type terminals
Baud rate	187.5 kbit/s	
Distance	AC500-XC: up to 500 m; up to 2000 m using a repeater	
Max. number of modules on fieldbus	31 modules max. Please note: The CS31 bus interface occupies one or two module addresses (if counters are configured onboard or if the module is a mixed digital analog module). Depending on the configuration, or if the module contains also mixed digital analog I/O, connected extension modules can occupy further module addresses.	
Configuration		
Station address configuration	Using configuration tool (included in Automation Builder software suite)	Using rotary switches (99 max.)

Digital I/O modules, "Fast Counter" operating modes. Not applicable for DC541-XC (1)

Operating mode, configured in the user program of the AC500-XC	Occupied inputs DI or DC	Occupied outputs DO or DC	Maximum counting frequency kHz
0 No counter	0	0	–
1 One count-up counter with "end value reached" indication	1	1	50
2 One count-up counter with "enable" input and "end value reached" indication	2	1	50
3 Two up/down counters	2	0	50
4 Two up/down counters with 1 counting input inverted	2	0	50
5 One up/down counter with "dynamic set" input	2	0	50
6 One up/down counter with "dynamic set" input	2	0	50
7 One up/down counter with directional discriminator For synchro transmitters using two counting pulses with an offset of 90° (track A and B)	2	0	50
8 –	0	0	–
9 One up/down counter with directional discriminator and double evaluation For synchro transmitters using two counting pulses with an offset of 90° towards each other (track A and B)	2	0	30
10 One up/down counter with directional discriminator and fourfold evaluation For synchro transmitters using two counting pulses with an offset of 90° towards each other (track A and B)	2	0	15

(1) See technical documentation for details.

AC500-XC

System data

Environmental Conditions

Process and supply voltages

24 V DC	Voltage	24 V (-15%, +20%)
	Protection against reverse polarity	yes
120V...240V AC Wide Range Supply	Voltage	120...240 V (-15 %, +10 %)
	Frequency	50/60 Hz (-6 %, +4%)
Allowed interruptions of power supply	DC supply	Interruption < 10 ms, time between 2 interruptions > 1 s, PS2
	AC supply	Interruption < 0.5 periods, time between 2 interruptions > 1 s

Important: Exceeding the maximum process and supply voltages could lead to unrecoverable damage of the system. The system could be destroyed. For the supply of the modules, power supply units according to PELV or SELV specifications must be used. The creepage distances and clearances meet the requirements of the overvoltage category II, pollution degree 2.

Temperature

Operating	-40 °C ... +70 °C	
	-40 °C ... -30 °C	Proper start-up of system; technical data not guaranteed
	-40 °C ... 0 °C	Due to the LCD technology, the display might not be readable
	-40 °C...+40 °C	vertical mounting of modules possible, output load limited to 50 % per group
	+60 °C ...+70 °C	with the following deratings: System is limited to max. 2 Communication Modules per Terminal Base Applications certified for cULus up to 60 °C Digital inputs: maximum number of simultaneously switched on input channels limited to 75 % per group (e.g. 8 channels => 6 channels) Digital outputs: output current maximum value (all channels together) limited to 75 % per group (e.g. 8 A => 6 A) Analog outputs only if configured as voltage output: maximum total output current per group is limited to 75 % (e.g. 40 mA => 30 mA) Analog outputs only if configured as current output: maximum number of simultaneously used output channels limited to 75 % per group (e.g. 4 channels => 3 channels)
Storage / Transport	-40 °C ... +85 °C	

Humidity

Operating / Storage	100 % r. H. with condensation
---------------------	-------------------------------

Air pressure

Operating	-1000 m 4000 m (1080 hPa ... 620 hPa) >2000 m (<795 hPa): max. operating temperature must be reduced by 10 K (e.g. 70 °C to 60°C)
-----------	---

Immunity to corrosive gases

Operating	Yes, according to: ANSI/ISA-71.04: Containment group A, G3 - Harsh / GX - Severe IEC 60068-2-60: Method 4 IEC 60721-3-3: Class 3C2 / 3C3 Gases and concentrations: Hydrogen sulfide (H ₂ S): (10 ± 5) ppb Nitrogen dioxide (NO ₂): (200 ± 20) ppb Chlorine (Cl ₂): (10 ± 5) ppb Sulfur dioxide (SO ₂): (200 ± 20) ppb
-----------	---

AC500-XC

System data

Environmental Conditions

Immunity to salt mist

Operating	Yes, horizontal mounting only, according to: IEC 60068-2-52 severity level: 1 NOTICE! Risk of corrosion! Unused connectors and slots may corrode, if using XC devices in salt mist environments. Protect unused connectors and slots with TA535 protective caps for XC devices.
-----------	---

Electromagnetic Compatibility

Radiated emission (radio disturbances)	Yes, according to: CISPR 16-2-3
Conducted emission (radio disturbances)	Yes, according to: CISPR 16-2-1, CISPR 16-1-2
Electrostatic discharge (ESD)	Yes, according to: IEC 61000-4-2, zone B, criterion B Electrostatic voltage in case of air discharge: 8 kV Electrostatic voltage in case of contact discharge: 6 kV
Fast transient interference voltages (burst)	Yes, according to: IEC 61000-4-4, zone B, criterion B Supply voltage units (DC): 4 kV Digital inputs/outputs (24 V DC): 2 kV Analog inputs/outputs: 2 kV Communication lines shielded: 2 kV I/O supply (DC-out): 2 kV
High energy transient interference voltages (surge)	Yes, according to: IEC 61000-4-5, zone B, criterion B Supply voltage units (DC): 1 kV CM* / 0.5 kV DM* Supply voltage units (AC): 2 kV CM* / 1 kV DM* Digital inputs/outputs (24 V DC): 1 kV CM* / 0.5 kV DM* Digital inputs/outputs (120...240 V AC): 2 kV CM* / 1 kV DM* Analog inputs/outputs: 1 kV CM* / 0.5 kV DM* Communication lines shielded: 1 kV CM* I/O supply (DC-out): 0,5 kV CM* / 0.5 kV DM* * CM = Common Mode, * DM = Differential Mode
Influence of radiated disturbances	Yes, according to: IEC 61000-4-3, zone B, criterion A Test field strength: 10 V/m
Influence of line-conducted interferences	Yes, according to: IEC 61000-4-6, zone B, criterion A Test voltage: 10 V
Influence of power frequency magnetic fields	Yes, according to: IEC 61000-4-8, zone B, criterion A 30 A/m 50 Hz 30 A/m 60 Hz

In order to prevent malfunctions, it is recommended, that the operating personnel discharge themselves prior to touching communication connectors or perform other suitable measures to reduce effects of electrostatic discharges.

WARNING!

Risk of malfunctions and damages to persons!

Unused slots for Communication Modules are not protected against accidentally touch. Dust and Dirt may cause contact problems and malfunctions.
Unused slots for Communication Modules must be covered with Dummy Communication Modules ("TA524 - Dummy Communication Module").

I/O-Bus connectors must not be touched during operation.

AC500-XC

System data

Environmental Conditions

Environmental Tests		
Storage		IEC 60068-2-1 Test Ab: cold withstand test -40 °C / 16 h
		IEC 60068-2-2 Test Bb: dry heat withstand test +85 °C / 16 h
Humidity		IEC 60068-2-30 Test Db: Cyclic (12 h / 12 h) Damp-Heat Test 55 °C, 93 % r. H. / 25 °C, 95 % r. H., 6 cycles
		IEC 60068-2-78, Stationary Humidity Test: 40 °C, 93 % r. H., 240 h
		IEC 61131-2 / IEC 60068-2-6: 5 Hz ... 500 Hz, 2 g (with SD Memory Card inserted)
		IEC 60068-2-64: 5 Hz ... 500 Hz, 4 g rms
Shock resistance		IEC 60068-2-27: all 3 axes 15 g, 11 ms, half-sinusoidal
Mechanical Data		
Wiring method		Spring terminals / Screw terminals
Degree of protection		IP 20
Vibration resistance		Yes, according to: IEC 61131-2 IEC 60068-2-6 IEC 60068-2-64
Shock resistance		Yes, according to: IEC 60068-2-27
Assembly position		Horizontal Vertical (no application in salt mist environment)
Assembly on DIN rail	DIN rail type	According to IEC 60715 35 mm, depth 7.5 mm or 15 mm
Assembly with screws	Screw diameter	4 mm
	Fastening torque	1.2 Nm

AC500-S

Functional Safety PLC

169	Key features
170	Ordering data AC500-S
171	Ordering data AC500-S-XC
172–174	Technical data
175–178	System data

SM560-S

ABB

WR
DIAG
RUN
ERR
ERR

1 2 3 4 5 6 7 8 9
0 F E D C B A ADDR x10H

1 2 3 4 5 6 7 8 9
0 F E D C B A ADDR x01H

SYS
BATT
I/O-Bus

run

ETH
FBP
COM
COM

PWR



RUN



ERR



WARNING
Use of
incorrect
battery may
cause fire or
explosion.

RUN
VAL
ESC
OK

DIAG
CFG
↑
↓

MC
502

UP 24VDC 10W

AC500-S

Key features

—

Easy integration: Simple expansion of ABB PLC with safety functions. One common engineering and diagnostic system for safety and standard CPUs. eXtreme Conditions (-XC) version is available.



—

Easy implementation of flexible configuration concept (one safety program for various machine types). Safety CPU can be configured to work even if standard CPU is in STOP mode.

—

Automation Builder productivity suite providing integrated support of ST, Ladder (LD) and Function Block Diagram (FBD) programming. Trigonometric functions are supported for easy implementation of complex calculation tasks.

—

PROFINET/PROFIsafe interface for decentralized safety I/Os, safe position and speed monitoring as well as triggering of safety drive functions.

AC500-S

Ordering data

Safety CPU

Description	User program memory		Type	Order code	Price	Weight (1 pce) kg
	MB					
Safety CPU module	1		SM560-S	1SAP280000R0001		0.100
Safety CPU module with F-Device functionality for 1 PROFI-safe network	1.3		SM560-S-FD-1	1SAP286000R0001		0.100
Safety CPU module with F-Device functionality for 4 PROFI-safe networks	1.3		SM560-S-FD-4	1SAP286100R0001		0.100

S500 Safety I/O

Description	Input signal		Output signal SIL3	Type	Order code	Price	Weight (1 pce) kg
	SIL2	SIL3					
Safety digital input module	16	8	-	DI581-S	1SAP284000R0001		0.130
Safety digital input / output module	8	4	8	DX581-S	1SAP284100R0001		0.130
Safety analog input module	4	2	-	AI581-S	1SAP282000R0001		0.130

S500 Safety terminal unit

Description	Type	Order code	Price	Weight (1 pce) kg
Spring terminal unit for safety I/O modules	TU582-S	1SAP281200R0001		0.200

Software

AC500-S Safety PLC programming license needs to be purchased as an additional feature of Automation Builder. For details, see ordering data of Automation Builder.



SM560-S
SM560-S-FD-1
SM560-S-FD-4



DI581-S
DX581-S
AI581-S



TU582-S

Accessories for AC500-S

For	Description	Type	Order code	Price	Weight (1 pce) kg
AC500-S Safety PLC	SM560-S, DI581-S, DX581-S, AI581-S, TU582-S with PM573-ETH and PNIO	TA514-SAFETY	1SAP182900R0001		10



AC500-S training case

AC500-S-XC

Ordering data

Safety XC CPU

Description	User program memory		Type	Order code	Price	Weight (1 pce) kg
	MB					
Safety CPU module	1		SM560-S-XC	1SAP380000R0001		0.100
Safety CPU module with F-Device functionality for 1 PROFI-safe network	1.3		SM560-S-FD-1-XC	1SAP386000R0001		0.100
Safety CPU module with F-Device functionality for 4 PROFI-safe networks	1.3		SM560-S-FD-4-XC	1SAP386100R0001		0.100

S500-XC Safety I/O

Description	Input signal		Output signal SIL3	Type	Order code	Price	Weight (1 pce) kg
	SIL2	SIL3					
Safety digital input module	16	8	-	DI581-S-XC	1SAP484000R0001		0.130
Safety digital input / output module	8	4	8	DX581-S-XC	1SAP484100R0001		0.130
Safety analog input module	4	2	-	AI581-S-XC	1SAP482000R0001		0.130

S500-XC Safety terminal unit

Description	Type	Order code	Price	Weight (1 pce) kg
Spring terminal unit for safety I/O modules	TU582-S-XC	1SAP481200R0001		0.200



SM560-S-XC
SM560-S-FD-1-XC
SM560-S-FD-4-XC



DI581-S-XC
DX581-S-XC
AI581-S-XC



TU582-S-XC

AC500-S and AC500-S-XC

Technical data

Safety CPUs

Type		SM560-S / SM560-S-XC	SM560-S-FD-1 / SM560-S-FD-4 / SM560-S-FD-1-XC / SM560-S-FD-4-XC
Performance level		PL e (ISO 13849-1)	
Safety	integrity level	SIL3 (IEC 61508:2010, IEC 62061, IEC 61511)	
	protocol	PROFIsafe V2 F-Host via PROFINET	PROFIsafe V2 F-Host and F-Device (for 1 or 4 PROFIsafe networks, respectively) via PROFINET
Program memory flash EPROM and RAM		1 MB	1.3 MB
Integrated data memory		1 MB thereof 120 KB saved	1.0 MB thereof 120 kB saved
Cycle time for 1 instruction			
Binary		0.05 µs	
Word		0.06 µs	
Floating point		0.5 µs	
Max. number of centralized inputs/outputs			
Max. nb. of safety extension modules on I/O bus		up to max. 10	
Digital	inputs	160 (SIL2) / 80 (SIL3)	
	outputs	80 (SIL3)	
Analog	inputs	40 (SIL2) / 20 (SIL3)	
Max. number of decentralized inputs/outputs		On PROFINET: up to 128 stations with up to 10 safety extension modules	
Program execution			
Cyclical		•	
User program protection by password		•	
Interfaces			
Ethernet		Via AC500 CPU or PROFINET coupler	
COM		Via AC500 CPU	
Programming		Via AC500 CPU	
Approvals		CE, cUL, UL, C-Tick and other on request	

AC500-S and AC500-S-XC

Technical data

S500 and S500-XC Safety I/O

Type	DI581-S / DI581-S-XC	DX581-S / DX581-S-XC	AI581-S / AI581-S-XC
Performance Level	PL e (ISO 13849-1)		
Safety Integrity Level	SIL3 (IEC 61508:2010, IEC 62061, IEC 61511)		
Safety protocol	PROFIsafe V2 via PROFINET		
Digital inputs			
Number of channels per module	16 (SIL2) / 8 (SIL3)	8 (SIL2) / 4 (SIL3)	-
Input signal voltage	24 V DC	24 V DC	-
Frequency range	65 Hz	65 Hz	-
Input characteristic acc. to EN61131-2	Type 1	Type 1	-
0 signal	-3...+5 V DC	-3...+5 V DC	-
Undefined signal state	5...15 V DC	5...15 V DC	-
1 signal	15...30 V DC	15...30 V DC	-
Input time delay (0 -> 1 or 1 -> 0)	Input filter configurable from 1, 2, 5...500 ms	Input filter configurable from 1, 2, 5...500 ms	-
Test pulse outputs	8	4	-
Input current per channel			
At input voltage	24 V DC / 7 mA typically	24 V DC / 7 mA typically	-
	5 V DC / < 1 mA	5 V DC / < 1 mA	-
	15 V DC / > 4 mA	15 V DC / > 4 mA	-
	30 V DC / < 8 mA	30 V DC / < 8 mA	-
Digital outputs			
Number of channels per module	-	8 (SIL3)	-
Transistor outputs 24 V DC, 0.5 A	-	●	-
Switching of 24 V load	-	●	-
Output current			
Nominal current per channel	-	500 mA at UP = 24 V	-
Maximum (total current of all channels)	-	4 A / 500 mA / channel	-
Residual current at signal state 0	-	< 0.5 mA	-
Demagnetization when switching off inductive loads	-	By internal suppressor diodes	-
Switching frequency			
Short-circuit / overload proofness	-	●	-
For inductive load	-	On request	-
For lamp load	-	On request	-
Proofness against reverse feeding of 24 V signals	-	●	-

AC500-S and AC500-S-XC

Technical data

S500 and S500-XC Safety I/O

Type	DI581-S / DI581-S-XC	DX581-S / DX581-S-XC	AI581-S / AI581-S-XC
Analog inputs			
Number of channels per module	-	-	4 (SIL2) / 2 (SIL3)
Input resistance per channel	-	-	125 Ohm
Time constant of the input filter	-	-	10 ms
Conversion cycle	-	-	0.33 ms
Overvoltage protection	-	-	-
Signal resolution for channel configuration			
0...20 mA, 4...20 mA	-	-	14 bits
Process voltage UP			
Nominal voltage	24 V DC		
Maximum ripple	5 %		
Reverse polarity protection	●		
Fuse for process voltage UP	10 A miniature fuse		
Connections for sensor voltage supply Terminal 24 V and 0 V	●		
Conversion error of analog values caused by non-linearity, calibration errors ex and the resolution in the nominal range	-	-	±1.5 %
Maximum cable length for connected process signals			
Shielded cable	1000 m	1000 m	-
Unshielded cable	600 m	600 m	-
Max. line length of the analog lines, conductor cross section > 0.14 mm ²	-	-	100 m
Potential isolation			
Per module	●		
Fieldbus connection	Via AC500 CPU or PROFINET coupler		
Voltage supply for the module	Internally via extension bus interface (I/O bus)		
Approvals	CE, cUL, UL, C-Tick and other on request		

AC500-S

System data

Operating and ambient conditions

Voltages according to EN 61131-2

24 V DC	Process and supply voltage	24 V (-15%, +20%)
	Protection against reverse polarity	Yes
Allowed interruptions of power supply acc. to EN 61131-2	DC supply	Interruption < 10 ms, time between 2 interruptions > 1 s

Important: Exceeding the maximum process and supply voltages could lead to unrecoverable damage of the system. The system could be destroyed.

Temperature

Operating	0 °C ... +60 °C	horizontal mounting of modules
	0 °C ... +40 °C	vertical mounting of modules and output load reduced to 50 % per group
Storage / Transport	-40 °C ... +70 °C	

Humidity

Operating / Storage	Max. 95 %, without condensation
---------------------	---------------------------------

Air pressure

Operating	> 800 hPa / < 2000 m
Storage	> 660 hPa / < 3500 m

Creepage distances and clearances

Insulation Test Voltages, Routine Test, according to EN 61131-2	AC voltage during 2 seconds
24 V circuits (supply, 24 V inputs/outputs), if they are electrically isolated against other circuitry	350 V

The creepage distances and clearances meet the requirements of the overvoltage category II, pollution degree 2.

AC500-S

System data

Power supply units

For the supply of the modules, power supply units according to PELV specifications must be used.

Electromagnetic Compatibility

Immunity		
Against electrostatic discharge (ESD)		
Electrostatic voltage in case of		According to EN 61000-4-2, zone B, criterion B
air discharge		±8 kV
contact discharge		±6 kV
ESD with communication connectors		
		In order to prevent operating malfunctions, it is recommended, that the operating personnel discharge themselves prior to touching communication connectors or perform other suitable measures to reduce effects of electrostatic discharges.
ESD with connectors of Terminal Bases		
		The connectors between the Terminal Bases and CPUs or Communication Modules must not be touched during operation. The same is valid for the I/O-Bus with all modules involved.
Against the influence of radiated (CW radiated)		
Test field strength		According to EN 61000-4-3, zone B, criterion A
		10 V/m
Against transient interference voltages (burst)		
Supply voltage units		According to EN 61000-4-4, zone B, criterion B
DC		2 kV
Digital inputs/outputs	24 V DC	2 kV
Analog inputs		1 kV
Against the influence of line-conducted interferences (CW conducted)		
Test voltage		According to EN 61000-4-6, zone B, criterion A
		10 V zone B
High energy surges		
Power supply		According to EN 61000-4-5, zone B, criterion B
DC		1 kV CM (1) / 0.5 kV DM (2)
DC I/O supply, add. DC-supply-out		0.5 kV CM (2) / 0.5 kV DM (2)
I/O analog, I/O DC unshielded		1 kV CM (2) / 0.5 kV DM (2)
Radiation (radio disturbance)		
		According to EN 55011, group 1, class A

(1) High requirement for shipping classes is achieved with additional specific measures (see specific documentation).

(2) CM = Common Mode; DM = Differential Mode.

Mechanical Data

Wiring method / terminals	
Mounting	Horizontal (DIN rail mounting)
Degree of protection	IP20
Housing	According to UL 94
Vibration resistance acc. to EN 61131-2	all three axes (DIN rail mounting) 5...11.9 Hz, continuous 3.5 mm 11.9...150 Hz, continuous 1 g
Shock resistance	All three axes 15 g, 11 ms, half-sinusoidal
Mounting of the modules	
DIN rail according to DIN EN 50022	35 mm, depth 7.5 mm or 15 mm
Mounting with screws	Screws with a diameter of 4 mm
Fastening torque	1.2 Nm

AC500-S-XC

System data

Operating and ambient conditions

Voltages according to EN 61131-2

24 V DC	Process and supply voltage	24 V (-15%, +20%)
	Protection against reverse polarity	Yes
Allowed interruptions of power supply acc. to EN 61131-2	DC supply	Interruption < 10 ms, time between 2 interruptions > 1 s

Important: Exceeding the maximum process and supply voltages could lead to unrecoverable damage of the system. The system could be destroyed.

Temperature

Operating	-40 °C ... +70 °C	horizontal mounting of modules
	-40 °C ... +40 °C	vertical mounting of modules and output load reduced to 50 % per group
Storage / Transport	-40 °C ... +85 °C	

Humidity

Operating / Storage	Max. 100 %, with condensation
---------------------	-------------------------------

Air pressure

Operating	620...1080 hPa / (-1000...4000 m) > 2000 m (< 795 hPa): max. operating temperature must be reduced by 10 °C.
Storage	> 620 hPa / < 4000 m

Creepage distances and clearances

Insulation Test Voltages, Routine Test, according to EN 61131-2	AC voltage during 2 seconds
24 V circuits (supply, 24 V inputs/outputs), if they are electrically isolated against other circuitry	350 V

The creepage distances and clearances meet the requirements of the overvoltage category II, pollution degree 2.

AC500-S-XC

System data

Power supply units

For the supply of the modules, power supply units according to PELV specifications must be used.

Electromagnetic Compatibility

Immunity		
Against electrostatic discharge (ESD)		
Electrostatic voltage in case of		According to EN 61000-4-2, zone B, criterion B
air discharge		±8 kV
contact discharge		±6 kV
ESD with communication connectors		
In order to prevent operating malfunctions, it is recommended, that the operating personnel discharge themselves prior to touching communication connectors or perform other suitable measures to reduce effects of electrostatic discharges.		
ESD with connectors of Terminal Bases		
The connectors between the Terminal Bases and CPUs or Communication Modules must not be touched during operation. The same is valid for the I/O-Bus with all modules involved.		
Against the influence of radiated (CW radiated)		
Test field strength		According to EN 61000-4-3, zone B, criterion A
		10 V/m
Against transient interference voltages (burst)		
Supply voltage units		DC
		2 kV
Digital inputs/outputs		24 V DC
		2 kV
Analog inputs		1 kV
Against the influence of line-conducted interferences (CW conducted)		
Test voltage		According to EN 61000-4-6, zone B, criterion A
		10 V zone B
High energy surges		
Power supply		DC
		1 kV CM (1) / 0.5 kV DM (2)
DC I/O supply, add. DC-supply-out		0.5 kV CM (2) / 0.5 kV DM (2)
I/O analog, I/O DC unshielded		1 kV CM (2) / 0.5 kV DM (2)
Radiation (radio disturbance)		
According to EN 55011, group 1, class A		

(1) High requirement for shipping classes is achieved with additional specific measures (see specific documentation).

(2) CM = Common Mode; DM = Differential Mode.

Mechanical Data

Wiring method / terminals	
Mounting	Horizontal (DIN rail mounting)
Degree of protection	IP20
Housing	According to UL 94
Vibration resistance acc. to EN 61131-2	all three axes (DIN rail mounting) 5...11.9 Hz, continuous 3.5 mm 11.9...150 Hz, continuous 1 g
Shock resistance	All three axes 15 g, 11 ms, half-sinusoidal
Mounting of the modules	
DIN rail according to DIN EN 50022	35 mm, depth 7.5 mm or 15 mm
Mounting with screws	Screws with a diameter of 4 mm
Fastening torque	1.2 Nm

CP600-eCo, CP600 and CP600-Pro

Control panels

183	Key features
184–186	Ordering data
187–190	Technical data

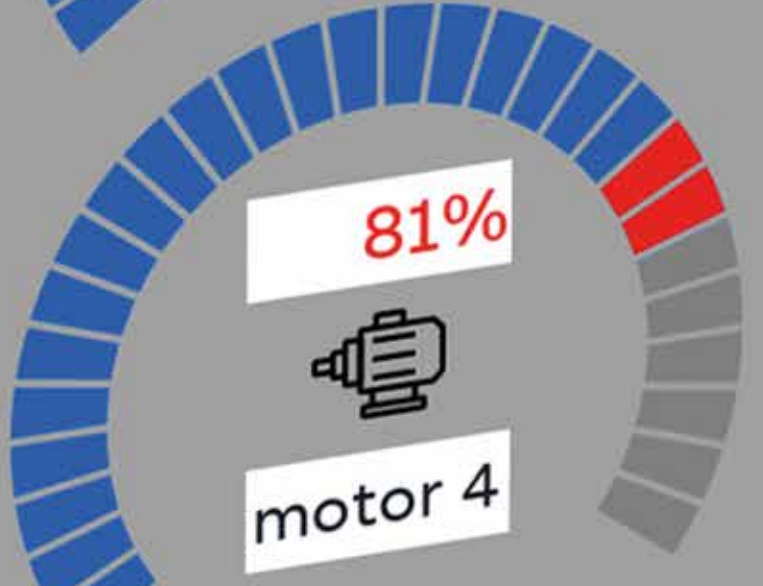
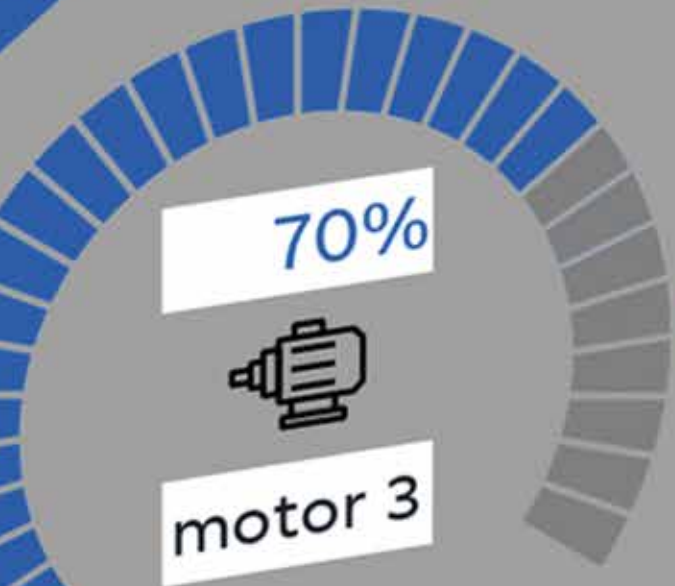
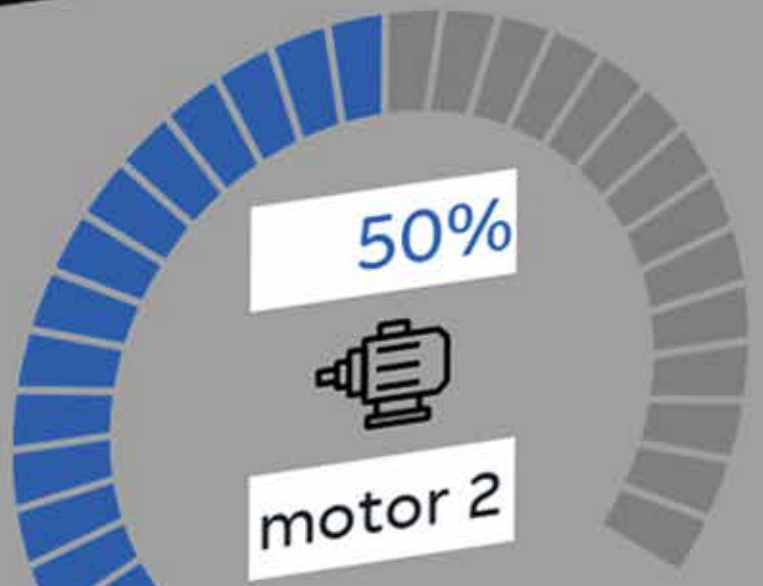
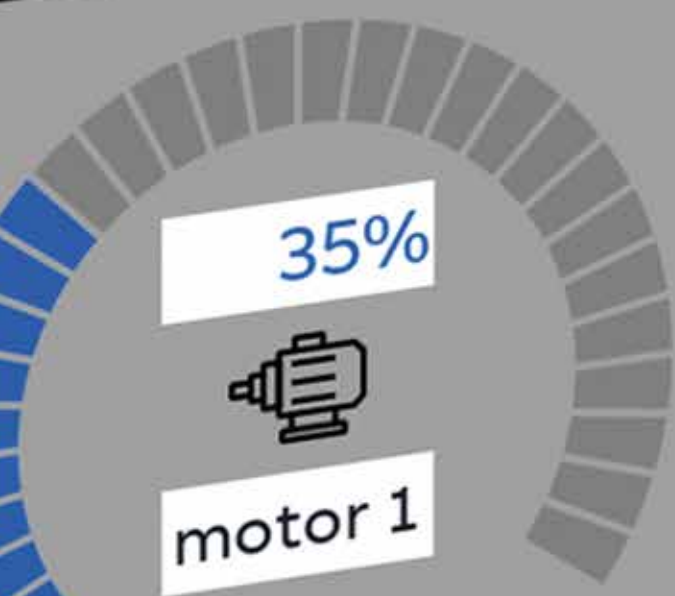

info



alarm



start



stop

CP600-eCo, CP600 and CP600-Pro

Key features

Various options for tailor made HMI solutions:

- PB610 Panel Builder 600 HMI applications
- Visualization of AC500 web servers
- Mobile remote access to HMI applications
- PB610-R PC runtime for Windows platforms



- Brilliant colored display
- Seven different screen sizes

- Multi-touch
- Brilliant true glass screen
- Fast ETH 10/100/1000
- Operating temp.: -20...+60 °C
- Screen sizes from 5" to 21.5"

- Slim design for easy installation even in compact spaces
- Robust plastic housing

CP600-eCo, CP600 and CP600-Pro

Ordering data

CP600-eCo control panels

Display size	Resolution pixels	Description	Type	Order code	Price	Weight (1 pce) kg
4.3"	480 x 272	for PB610 applications or visualization of AC500 V3 web server	CP604	1SAP504100R0001		0.400
7.0"	800 x 480	for PB610 applications or visualization of AC500 V3 web server	CP607	1SAP507100R0001		0.600
10.1"	1024 x 600	for PB610 applications or visualization of AC500 V3 web server	CP610	1SAP510100R0001		1.000
4.3"	480 x 272	black, for PB610 applications or visualization of AC500 V3 web server	CP604-B	1SAP504100R2001		0.400
7.0"	800 x 480	black, for PB610 applications or visualization of AC500 V3 web server	CP607-B	1SAP507100R2001		0.600
10.1"	1024 x 600	black, for PB610 applications or visualization of AC500 V3 web server	CP610-B	1SAP510100R2001		1.000



CP604



CP607



CP610



CP607-B

CP600 control panels

Display size	Resolution pixels	Description	Type	Order code	Price	Weight (1 pce) kg
4.3"	480 x 272	for PB610 Panel Builder 600 applications	CP620	1SAP520100R0001		0.950
4.3"	480 x 272	for visualization of AC500 V2 or V3 web server	CP620-WEB	1SAP520200R0001		0.950
5.7"	320 x 240	for PB610 Panel Builder 600 applications	CP630	1SAP530100R0001		1.150
5.7"	320 x 240	for visualization of AC500 V2 or V3 web server	CP630-WEB	1SAP530200R0001		1.150
7.0"	800 x 480	for PB610 Panel Builder 600 applications	CP635	1SAP535100R0001		1.100
7.0"	800 x 480	black, for PB610 Panel Builder 600 applications	CP635-B (*)	1SAP535100R2001		1.100
7.0"	800 x 480	for visualization of AC500 V2 or V3 web server	CP635-WEB	1SAP535200R0001		1.100
10.4"	800 x 600	for PB610 Panel Builder 600 applications	CP651	1SAP551100R0001		2.100
10.4"	800 x 600	for visualization of AC500 V2 or V3 web server	CP651-WEB	1SAP551200R0001		2.100
12.1"	800 x 600	for PB610 Panel Builder 600 applications	CP661	1SAP561100R0001		2.800
12.1"	800 x 600	for visualization of AC500 V2 or V3 web server	CP661-WEB	1SAP561200R0001		2.800
13.3"	1280 x 800	for PB610 Panel Builder 600 applications	CP665	1SAP565100R0001		2.600
13.3"	1280 x 800	for visualization of AC500 V2 or V3 web server	CP665-WEB	1SAP565200R0001		2.600
15"	1024 x 768	for PB610 Panel Builder 600 applications	CP676	1SAP576100R0001		3.800
15"	1024 x 768	for visualization of AC500 V2 or V3 web server	CP676-WEB	1SAP576200R0001		3.800

(*) Other control panels with black front on request.



CP635



CP651



CP665



CP635-B

CP600-eCo, CP600 and CP600-Pro

Ordering data

CP600-Pro control panels

Display size	Resolution pixels	Description	Type	Order code	Price	Weight (1 pce) kg
5.0"	800 x 480	for PB610 applications or visualization of AC500 V3 web server	CP6605	1SAP560510R0001		1.000
7.0"	800 x 480	for PB610 applications or visualization of AC500 V3 web server	CP6607	1SAP560710R0001		1.300
10.1"	1280 x 800	for PB610 applications or visualization of AC500 V3 web server	CP6610	1SAP561010R0001		1.700
15.6"	1366 x 768	for PB610 applications or visualization of AC500 V3 web server	CP6615	1SAP561510R0001		4.100
21.5"	1920 x 1080	for PB610 applications or visualization of AC500 V3 web server	CP6621	1SAP562110R0001		6.100



CP6605



CP6607



CP6610



CP6615



CP6621

CP600-eCo, CP600 and CP600-Pro

Ordering data

CP600 control panels, sanitary design

Display size	Resolution pixels	Description	Type	Order code	Price	Weight (1 pce) kg
7.0"	800 x 480	stainless steel frame, front: IP69K, blue for PB610 Panel Builder 600 applications	CP635-FB	1SAP535110R6001		1.500
7.0"	800 x 480	stainless steel frame, front: IP69K, white for PB610 Panel Builder 600 applications	CP635-FW	1SAP535110R1001		1.500



CP635-FB



CP635-FW

Communication cables (connection control panel <--> PLC)

Description	Type	Order code	Price	Weight (1 pce) kg
Communication cable RS232: CP600-eCo, CP600, CP600-Pro <--> AC500	TK681	1SAP500981R0001		0.130
Communication cable RS485: CP600-eCo, CP600, CP600-Pro <--> AC500-eCo	TK682	1SAP500982R0001		0.130

Programming software licenses

Description	Type	Order code	Price	Weight (1 pce) kg
PB610 Panel Builder 600, engineering tool license for CP600-eCo, CP600, CP600-Pro control panels and PB610-R PC-runtime, for stand-alone installation via Automation Builder installer. PB610 is included in Automation Builder Standard.	PB610	1SAP500900R0101		0.005
PB610-R Panel Builder 600 runtime license for running a PB610 application on one Windows 32-/64-Bit platform. Installation via Automation Builder installer.	PB610-R	1SAP500901R0101		0.005

CP600 platform selection guide for tailor made HMI applications

CP600-eCo	for PB610 HMI applications or visualization of AC500 V3 web server
CP600	for PB610 HMI applications
CP600-WEB	for visualization of AC500 V2 or V3 web server
CP600-Pro	for PB610 HMI applications or visualization of AC500 V3 web server

CP600-eCo series

Technical data

Type	CP604 CP604-B	CP607 CP607-B	CP610 CP610-B
Application	control panels for PB610 Panel Builder 600 applications or visualization of AC500 V3 web server		
Display			
Exact display size diameter	4.3" widescreen	7" widescreen	10.1" widescreen
Resolution	480 x 272 pixels	800 x 480 pixels	1024 x 600 pixels
Display type, colors	TFT-LCD, 65536 colors		
Touch screen material	glass covered by plastic film		
Touch screen type	single-touch, analog resistive, 4 wires		
Backlight type, life	LED, 20 000 h typ at 25 °C		
Brightness	150 cd/m ²	200 cd/m ²	
System resources			
Processor type	ARM 3352		
Operating system, version	Linux V3		
Application memory	for HMI projects of 30 MB in total plus 30 MB for fonts		
Interfaces			
Ethernet ports, number, type	1 - 10/100 Mbit		
USB Host ports number, type	1 - ver. 2.0		
Serial ports number, type	1 - RS-232/-485/-422 software configurable		
Card slot number, type	none		
Power supply			
Power supply voltage nominal, tolerance	24 V DC, 18...32 V DC		
Current consumption at nominal voltage	0.1 A	0.15 A	0.25 A
Backup power type	Supercapacitor, 72 h at 25 °C		
Housing			
Protection class front, rear	IP66, IP20		
Front frame material	Plastic		
Reverse side material	Plastic		
Weight	0.4 kg	0.6 kg	1.0 kg
Faceplate dimensions (L x H)	147 mm x 107 mm	187 mm x 147 mm	282 mm x 197 mm
Faceplate depth	5 mm		6 mm
Housing depth	29 mm		
Cutout dimensions (L x H)	136 mm x 96 mm	176 mm x 136 mm	271 mm x 186 mm
Environmental conditions			
Operating temperature range	0...50 °C		
Operating humidity range	5...85 % relative humidity, non-condensing		
Storage temperature range	-20...+70 °C		
Storage humidity range	5...85 % relative humidity, non-condensing		
Approvals	See detailed page 220 or www.abb.com/plc		

CP600 series

Technical data

Type	CP620	CP630	CP635, CP635-B	CP651	CP661	CP665	CP676
Application	control panels for PB610 Panel Builder 600 applications						
Type	CP620-WEB	CP630-WEB	CP635-WEB	CP651-WEB	CP661-WEB	CP665-WEB	CP676-WEB
Application	control panels for visualization of AC500 V2 or V3 web server						
Display							
Exact display size diameter	4.3" widescreen	5.7"	7" widescreen	10.4"	12.1"	13.3" widescreen	15"
Resolution	480 x 272 pixels	320 x 240 pixels	800 x 480 pixels	800 x 600 pixels	800 x 600 pixels	1280 x 800 pixels	1024 x 768 pixels
Display type, colors	TFT-LCD, 65536 colors						
Touch screen material	glass covered by plastic film						
Touch screen type	single-touch, analog resistive, 4 wires						
Backlight type, life	LED, 40 000 h typ at 25 °C						
Brightness	150 cd/m ²	200 cd/m ²	300 cd/m ²				
System resources							
Processor type	ARM Cortex A8: 600 MHz			ARM Cortex A8: 1 GHz			
Operating system, version	Microsoft Windows CE 6.0 Core						
Application memory	for HMI projects of up to 30 MB in total			for HMI projects of up to 60 MB in total			
Interfaces							
Ethernet ports, number, type	2 - 10/100 Mbit (with integrated switch function)						
USB Host ports number, type	1 - ver. 2.0	2 - 1 ver. 2.0, 1 ver. 2.0 and ver. 1.1					
Serial ports number, type	1 - RS-232/-485/-422 software configurable						
Card slot number, type	1 - SD card slot						
Power supply							
Power supply voltage nominal, tolerance	24 V DC, 18...32 V DC						
Current consumption at nominal voltage	0.4 A	0.7 A	0.7 A	1.0 A	1.05 A	1.15 A	1.4 A
Backup power type	Rechargeable Lithium battery, not user-replaceable						
Housing							
Protection class front, rear	IP66, IP20						
Front frame material	Zamak			Aluminium			
Reverse side material	Zamak	Aluminium					
Weight	0.95 kg	1.15 kg	1.1 kg	2.1 kg	2.8 kg	2.6 kg	3.8 kg
Faceplate dimensions (L x H)	147 x 107 mm	187 x 147 mm		287 x 232 mm	336 x 267 mm		392 x 307 mm
Faceplate depth	4 mm						
Housing depth	52 mm	47 mm		56 mm		60 mm	
Cutout dimensions (L x H)	136 x 96 mm	176 x 136 mm		276 x 221 mm	326 x 256 mm		381 x 296 mm
Environmental conditions							
Operating temperature range	0...50 °C						
Operating humidity range	5...85 % relative humidity, non-condensing						
Storage temperature range	-20...+70 °C						
Storage humidity range	5...85 % relative humidity, non-condensing						
Approvals	See detailed page 220 or www.abb.com/plc						

CP600-Pro series

Technical data

Type	CP6605	CP6607	CP6610	CP6615	CP6621
Application	control panels for PB610 Panel Builder 600 applications or visualization of AC500 V3 web server				
Display					
Exact display size diameter	5" widescreen	7" widescreen	10.1" widescreen	15.6" widescreen	21.5" widescreen
Resolution	800 x 480 pixels	800 x 480 pixels	1280 x 800 pixels	1366 x 768 pixels	1920 x 1080 pixels
Display type, colors	TFT-LCD, 65536 colors		TFT-LCD, 16 Mio colors		
Touch screen material	true glass, black passepartou				
Touch screen type	multi-touch, 2-points gestures, PCAP, projected capacitive touchscreen				
Backlight type, life time	LED, 40 000 h typ at 25 °C				
Brightness	300 cd/m ²	500 cd/m ²	500 cd/m ²	300 cd/m ²	300 cd/m ²
System resources					
Processor type	ARM Cortex-A8; 1 GHz	ARM Cortex-A9 dual core; 800 MHz	ARM Cortex-A9 dual core; 800 MHz	ARM Cortex-A9 quad core; 800 MHz	ARM Cortex-A9 quad core; 800 MHz
Operating system, version	Linux RT				
Application memory	for HMI projects of up to 240 MB in total				
Interfaces					
Ethernet ports, number, type	2 - 10/100 Mbit	2 - 10/100 Mbit 1 - 10/100/1000 Mbit			
USB Host ports, number, type	1 - ver. 2.0	2 - ver. 2.0			
Serial ports number, type	1 - RS-232/-485/-422 software configurable				
Card slot number, type	1 - SD card slot				
Power supply voltage nominal, tolerance					
Power supply voltage nominal, tolerance	24 V DC, 18...32 V DC				
Current consumption at nominal voltage	1.0 A	0.7 A	1.0 A	1.2 A	1.7 A
Backup power type, capacity	Rechargeable Lithium battery, not user-replaceable				
Housing					
Protection class front, rear	IP66, IP20				
Front frame material	aluminium, black				
Reverse side material	aluminium				
Weight	1.0 KG	1.3 kg	1.7 kg	4.1 kg	6.1 kg
Faceplate dimensions (L x H)	147 mm x 107 mm	187 mm x 147 mm	282 mm x 197 mm	422 mm x 267 mm	552 mm x 347 mm
Faceplate depth	8.0 mm	8.0 mm	8.0 mm	8.0 mm	8.5 mm
Housing depth	56 mm	47 mm	56 mm	56 mm	56 mm
Cutout dimensions (L x B)	136 mm x 96 mm	176 mm x 136 mm	271 mm x 186 mm	411 mm x 256 mm	541 mm x 336 mm
Environmental conditions					
Operating temperature range	-20...+60 °C				
Operating humidity range	5...85 % relative humidity, non-condensing				
Storage temperature range	-20...+70 °C				
Storage humidity range	5...85 % relative humidity, non-condensing				
Approvals	See detailed page 220 or www.abb.com/plc				

CP600 sanitary design

Technical data

Type	CP635-FB	CP635-FW
Application	control panels, sanitary design for PB610 Panel Builder 600 applications	
Display		
Exact display size diameter	7" widescreen	
Resolution	800 x 480 pixels	
Display front color	blue, RAL 5010	white, RAL 9003
Display type, colors	TFT type, 65536 colors	
Touch screen material	glass covered by protection foil	
Touch screen type	single-touch, PCAP, projected capacitive touchscreen	
Backlight type, life time	LED, 40 000 h typ at 25 °C	
Brightness	400 cd/m ²	
System resources		
Processor type	ARM Cortex A8: 1 GHz	
Operating system, version	Microsoft Windows CE 6.0 Core	
Memory	for HMI projects of up to 60 MB in total	
Interfaces		
Ethernet ports, number, type	2 - 10/100 Mbit (with integrated switch function)	
USB Host ports, number, type	2 - 1 ver. 2.0, 1 ver. 2.0 and ver. 1.1	
Serial ports number, type	1 - RS-232/-485/-422 software configurable	
Additional ports number, type	2 - Expansion slots for future modules	
Card slot number, type	1 - SD card slot	
Power supply		
Power supply voltage nominal, tolerance	24 V DC, 18...32 V DC	
Current consumption at nominal voltage	0.9 A	
Backup power type, capacity	Rechargeable Lithium battery, not user-replaceable	
Housing		
Protection class front, rear	IP69K, IP20	
Front frame material	stainless steel	
Reverse side material	aluminium	
Weight	1.5 kg	
Faceplate dimensions (L x H)	215 mm x 175 mm	
Faceplate depth	9.5 mm	
Housing depth	46 mm	
Cutout dimensions (L x B)	176 mm x 136 mm	
Environmental conditions		
Operating temperature range	-20...+60 °C	
Operating humidity range	5...85 % relative humidity, non-condensing	
Storage temperature range	-40...+85 °C	
Storage humidity range	5...85 % relative humidity, non-condensing	
Approvals	See detailed page 220 or www.abb.com/plc	

Application descriptions and additional information

194–195	AC500 HA offers hot standby redundancy
196–197	Hot Swap of S500 I/O modules for increased availability
198–199	S500 I/O modules run with various controllers
200–201	Condition Monitoring with AC500 PLC
202–203	Machine controllers based on AC500 PLC
204	Real-time Ethernet functionality
206–207	Embedding safety I/Os in ABB robots enhances man-machine collaboration
208–209	Safe communication between safety CPUs
210	PLC training and support
211	AC500-eCo Starter kit
212–213	AC31 adapter for retrofitting existing AC31 applications
214	Services
215	Life cycle management for maximum return on investment
216–218	Automation Builder product life cycle plan
220–225	Approvals and certifications



Application descriptions

AC500 HA offers hot standby redundancy

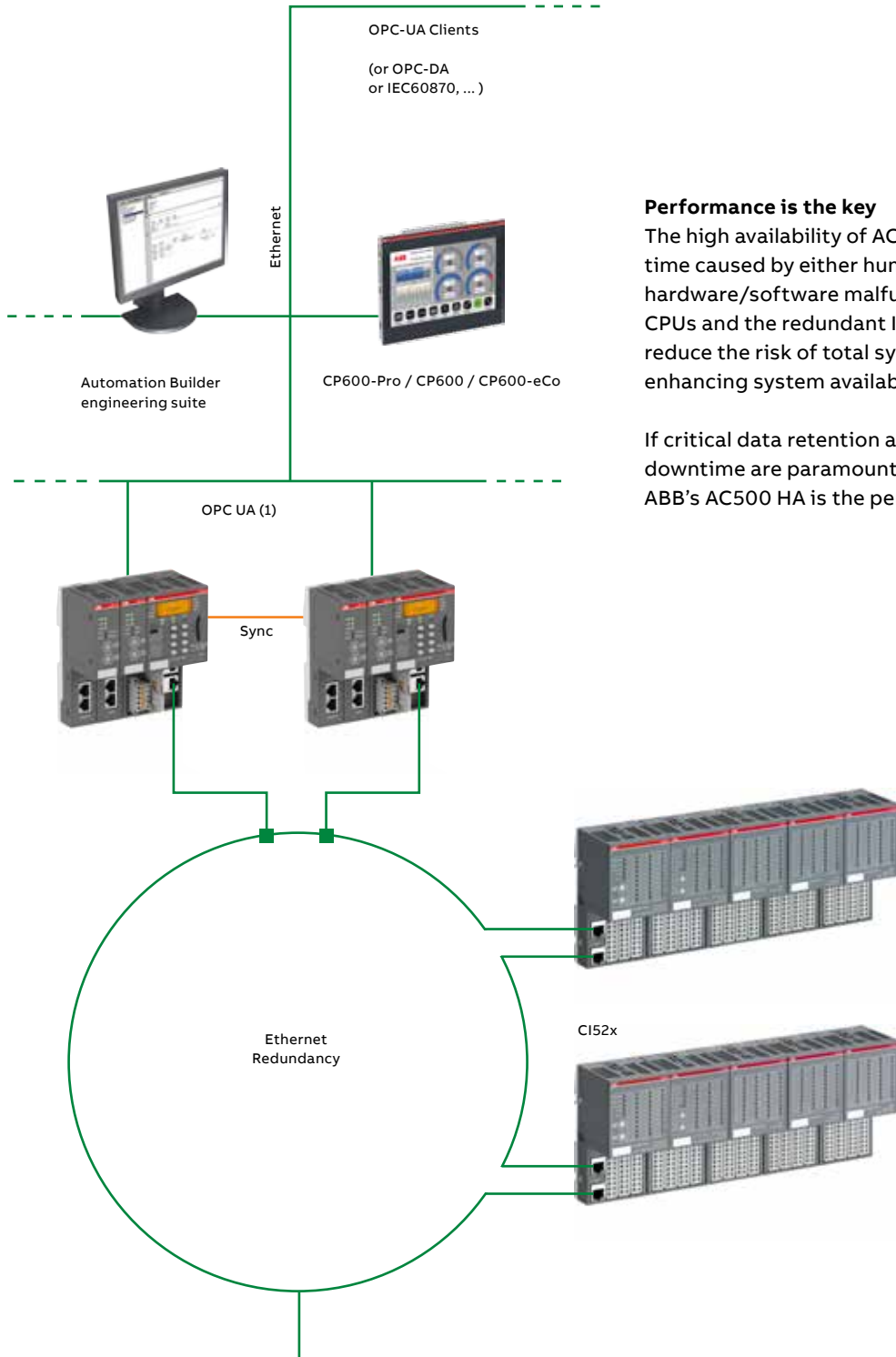

Performance is the key

The high availability of AC500 HA prevents downtime caused by either human error or cabling/hardware/software malfunction. Redundant CPUs and the redundant I/O communication reduce the risk of total system failure, thus enhancing system availability.

If critical data retention and the avoidance of downtime are paramount to your application, ABB's AC500 HA is the perfect solution.

08

(1) AC500 V3 CPUs only

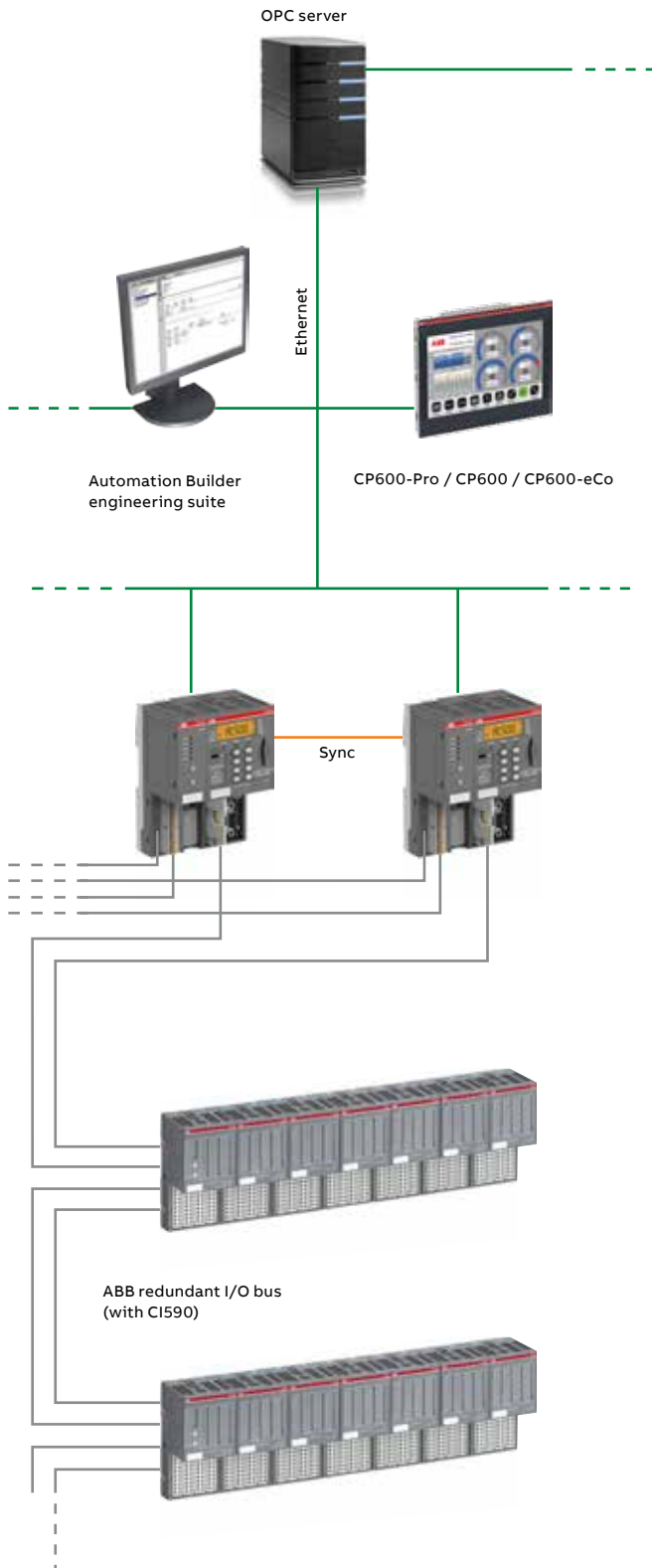

What are the benefits of AC500 HA for your high availability solution?

- Hot standby: Both CPUs (and all communication or bus-lines) are hot: Permanently running in parallel, continuously synchronizing each other and monitoring the system. If the primary CPU is stopped, powered off or crashed, or if an IO communication/cable has failed, the other hot standby CPU takes over immediately by adopting primary status.
- Higher resource utilization, no downtimes caused by cabling/hardware/software failure thanks to redundant CPUs and redundant communication to I/O and SCADA/HMI.
- Cost efficiency and easy system maintenance through the use of standard hardware.
- High availability is provided with standard CPUs. Cost matching hot standby quality for small or large systems.
- 3 cycles or 50 ms changeover time.
- Scalable in both variants: CS31 redundancy bus or Ethernet.

Application descriptions

Hot Swap of S500 I/O modules for increased availability



Replacing S500 I/O modules while the system is running

The hot swap terminal units TU516-H and TU532-H allow no-load hot swapping of S500 I/O modules during operation. When replacing an S500 I/O module the other modules in the cluster continue operating.

This capability is available for an I/O cluster with the following fieldbuses:

- PROFIBUS
- PROFINET
- Modbus TCP

Permanent wiring

Due to the construction of the S500 system, the wiring remains untouched during hot swap. There is no need to remove terminal blocks.

An S500 I/O module can be removed and replaced while the other modules in the configuration continue operating.

As soon as a module is re-inserted, it will be configured automatically and put into operation.

Applications

Hot swap is needed in hybrid applications when the control system must not be switched off during the replacement of a module.





Application descriptions

S500 I/O modules run with various controllers

S500 remote I/O

The availability of different fieldbus communication interfaces makes it easy to use S500 I/O modules as remote I/O for nearly any PLC and PC. The S500 remote I/O station consists of a communication interface and I/O modules. The smallest configuration can be just the communication interface with the onboard I/O channels. Communication interfaces are available for the following fieldbuses:

- PROFIBUS
- PROFINET/PROFIsafe
- EtherCAT
- Modbus TCP
- CANopen
- ABB CS31 System Bus

Easy engineering

The electronic configuration files that are provided by ABB for different fieldbus systems make it easy to configure the S500 remote I/O station in your engineering tool. The files such as GSD and GSDML are available for download at www.abb.com/plc. For Modbus TCP remote I/O stations a dedicated configurator is included in Automation Builder and for larger applications a Bulk Data Manager tool can be used.

S500 in hybrid applications with ABB DCS controller

The communication interfaces for PROFIBUS and PROFINET facilitate the integration of S500 as remote I/O stations in the ABB DCS controller AC 800M. System redundancy is supported with PROFINET. The configuration is integrated into the engineering tool of the DCS controller.

Third party PLC, IPC or machine controller

Controller can also be an IPC with ABB Ability™ for data center

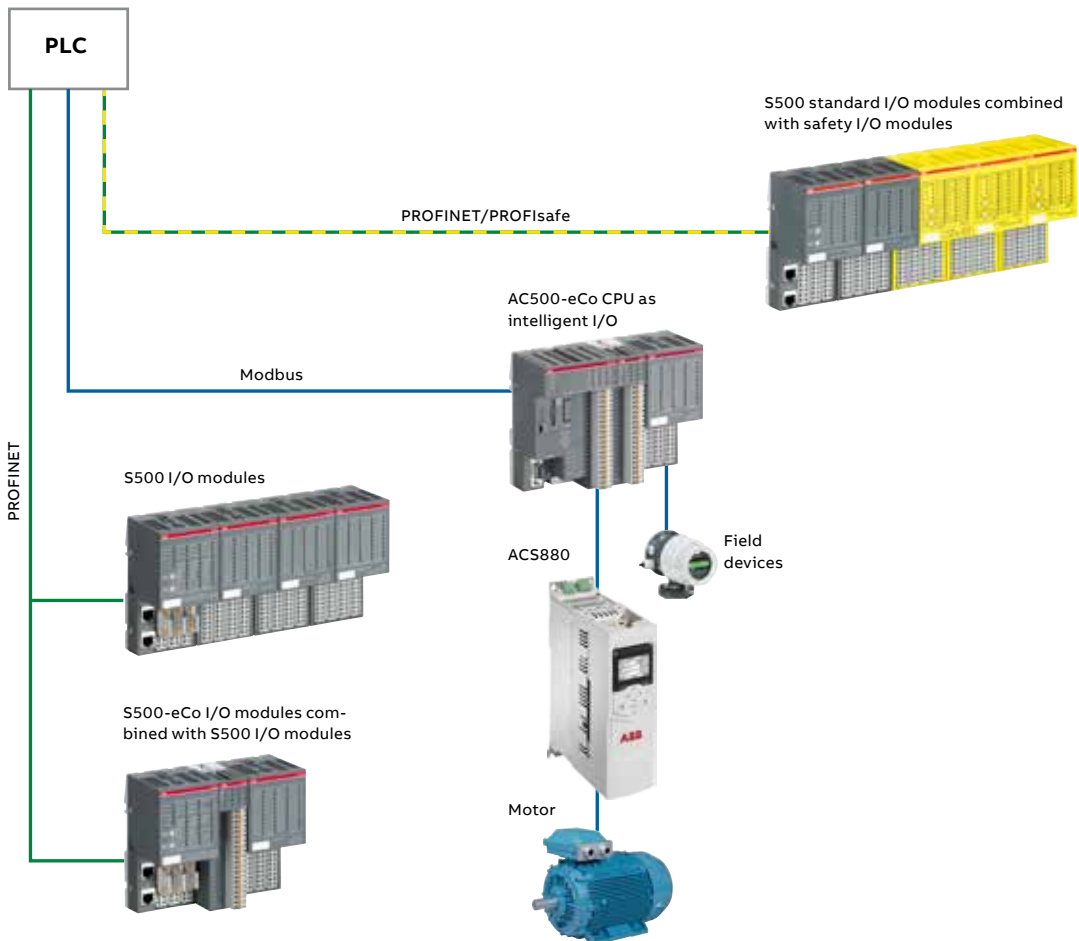

AC500-eCo CPU as S500 remote I/O

When the AC500-eCo compact CPU is used as remote I/O, it can be programmed with Automation Builder for local intelligence while communicating via the open protocols Modbus TCP or Modbus RTU with a CPU that will then be the master of this intelligent remote I/O station. The AC500-eCo CPU can be expanded by I/O modules from the S500 and S500-eCo range.

S500 remote I/O with Modbus TCP

ABB provides a configurator in the Automation Builder tool, which allows the configuration of Modbus TCP I/O stations with the communication interfaces CI521-MODTCP or CI522-MODTCP in the same style as the AC500 configuration. For larger applications a Bulk Data Manager tool can be used. The configuration can be stored in the communication interface, which allows using the configured station with any PLC or PC that supports Modbus TCP. This e.g. allows the use directly on other controllers or monitoring systems as e.g. ABB Ability™ Data Center Automation or external systems.

Thanks to the Modbus feature that allows several masters to exchange data with the same slave, it is possible to use the I/O station as shared devices with up to 10 PLC CPUs.

The Modbus masters can access the process data of the I/O stations in two different ways:

- Fixed mode: each I/O module in the station uses a separate register address range, which requires separate Modbus read/write operations for the modules in the station.
- The dynamic mode allows to pack the data of all I/O modules in the station in one data structure that can be exchanged in one single read/write operation.

S500 remote I/O with PROFINET/PROFIsafe

Simply extend your control system with ABB standard and safety I/Os to facilitate wiring, reduce operating costs and benefit from the unique features of our safety I/O portfolio to increase the productivity of your machines.

For more information about safety applications, please see application description Embedding safety I/Os in ABB robots on page 206.

ABB DCS AC 800M

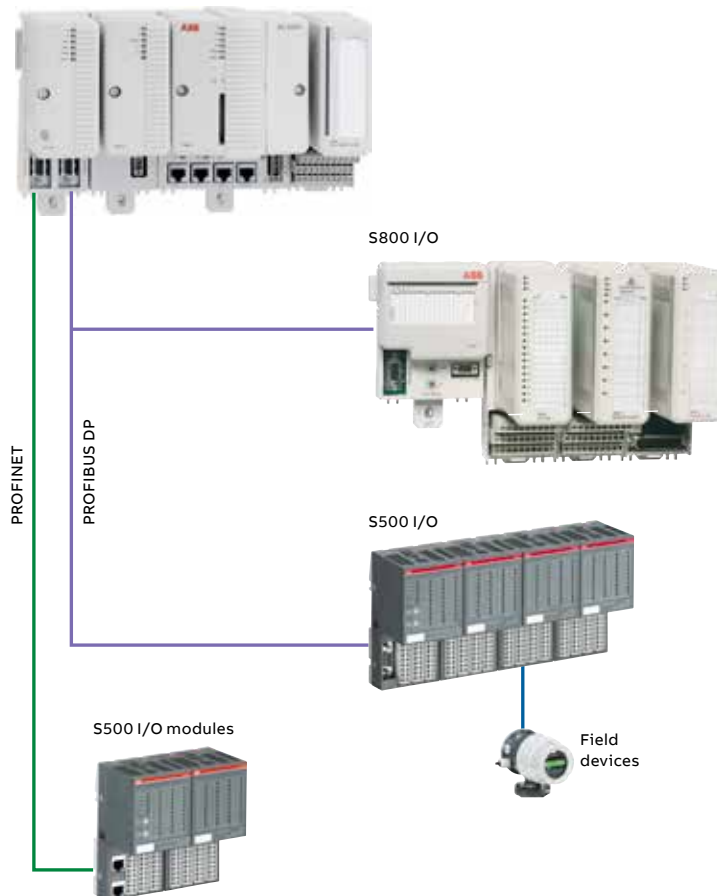

Application descriptions

Condition Monitoring with AC500 PLC

Controller integrated or stand-alone condition monitoring

The AC500 condition monitoring module FM502 is a natural part of the AC500 platform and Automation Builder engineering suite, and can be used in different condition monitoring concepts, stand-alone or control integrated.

Due to the easy programming in PLC languages, it is usable for a variety of use cases and is especially suitable for plant, line and machine builders as easy extension of their offering.

If controller integrated

- it enables at very reasonable cost
- the best prediction horizon as it can measure online, when best measurement quality is given without scheduling production interruptions
- while continuously protecting the application in real time e.g. with the same or other sensor(s).
- Further inputs can be used as fast data logger e.g. precisely documenting process quality.

Therefore it is not only able to continually check the mechanical components but also gives fast protection for spontaneous and large failures even while measuring. The condition monitoring mode creates a database internally or externally for predictive maintenance. Automatic and user assisted responses can be enabled to prevent

costly consequences including total failures.

As many as 16 vibration sensors + 2 encoder counters can be connected.

The recorded condition monitoring data can be stored in the CPU flash disc before communication or directly analyzed. Higher level indicators can be calculated and communicated to a local or remote HMI or database system.

Predictive performance for your process or machines

- Easy and cost saving integration of condition monitoring into the AC500 platform.
- Early detection of mechanical damages.
- Fast protection from spontaneous failures.
- Even complex C-code analytics can be used locally for meaningful own performance indicators.
- Leads to optimized planning of maintenance instead of fixed, scheduled service and spontaneous repair.
- No additional system or fixed software for diagnostics and visualization needed.
- Easy storage of the data, locally (4GB) or in remote servers and databases.
- Ideally suited also for retrofit of older equipment, as it can make use of mechanical reserves of still valuable equipment.



— AC500 Condition Monitoring Module FM502-CMS: Controller integrated or stand-alone CMS covering a complete drive train.

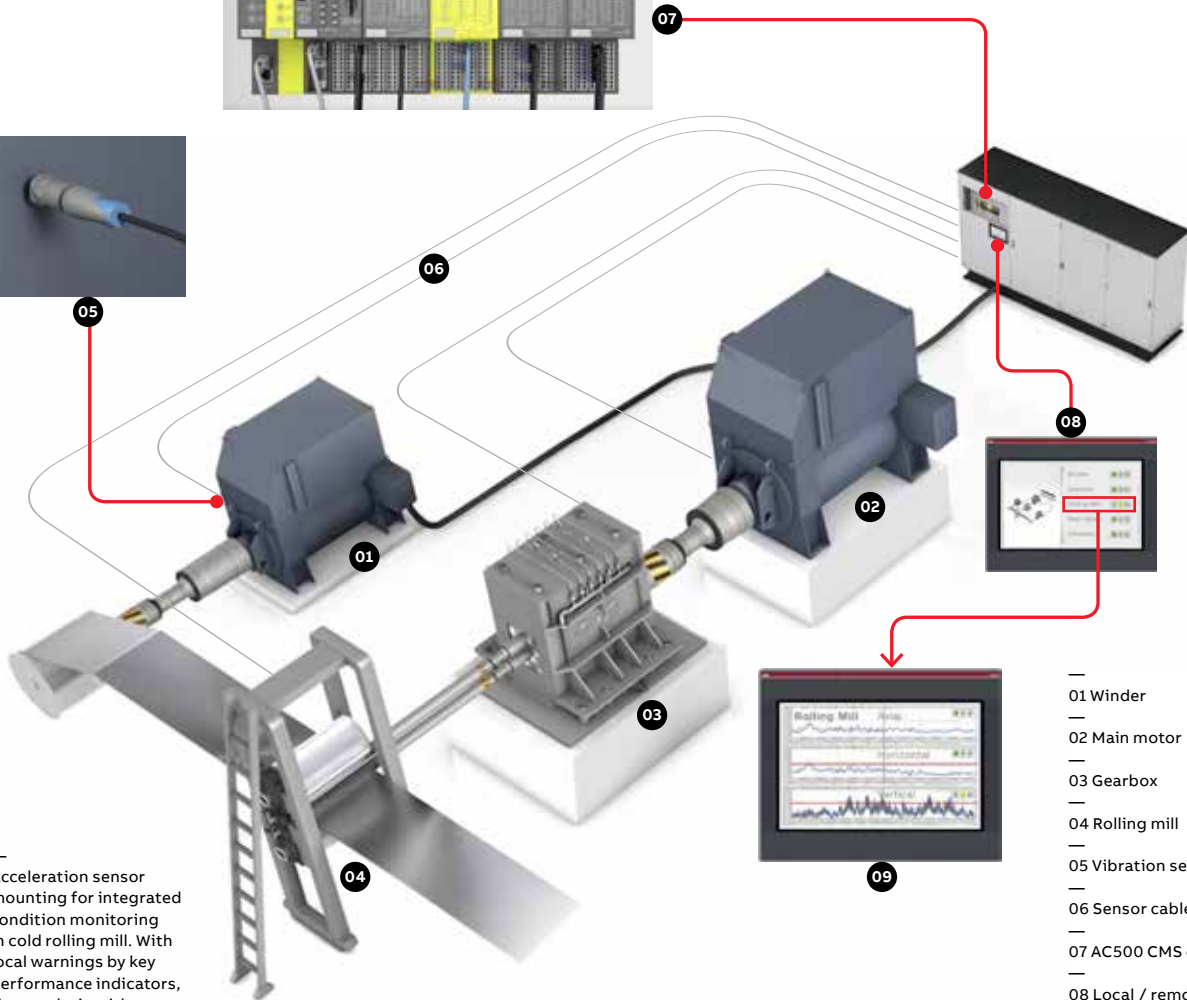
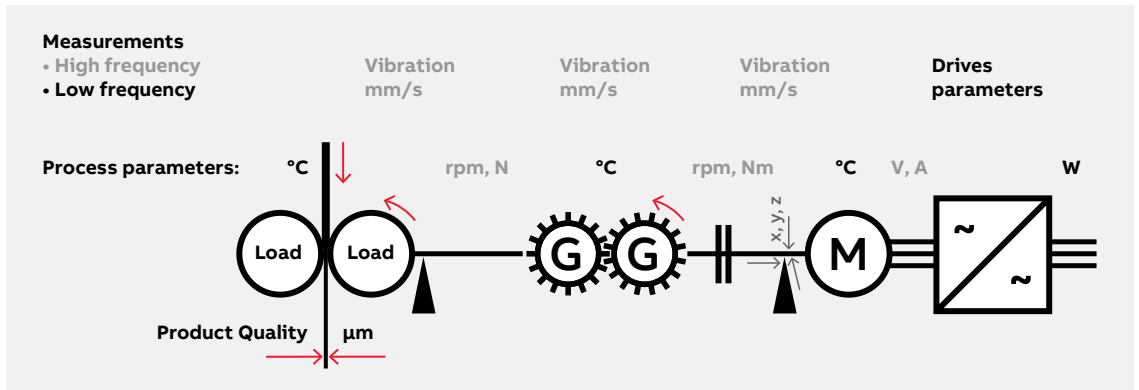

— Acceleration sensor mounting for integrated condition monitoring in cold rolling mill. With local warnings by key performance indicators, first analysis with detailed verification possibility via CP600 and remote connectivity.

- 01 Winder
- 02 Main motor
- 03 Gearbox
- 04 Rolling mill
- 05 Vibration sensor
- 06 Sensor cable
- 07 AC500 CMS controller integrated
- 08 Local / remote warning
- 09 Detailed analysis local / remote

Example: Cold rolling mill in steel processing:

- One FM502-CMS module can execute differently configured measurements at the same time and can be reconfigured at runtime.
- Several critical and unique components can be protected and condition predicted: Motors, gearbox, process (cold rolling mill).
- Production quality can be logged in parallel in real time.
- Remote diagnostics expertise and detailed analysis and reports only in case of warnings.

Application descriptions

Machine controllers based on AC500 PLC

From simple to high end motion applications

- Convenient PLC portfolio for diverse applications
 - Simple machine control with AC500-eCo PLC
 - Point-to-point motion with PTO outputs or Modbus communication with the drive
 - Mid-range applications with AC500 PLC
 - EtherCAT communication with the drive or remote I/O and cam-switch for synchronized motion
 - High-end motion application with PM595
 - Axis interpolation e.g. for Delta robot
- Easy integration and excellent scalability using Automation Builder
- Motion library for complex applications

Multi-axis motion coordination with EtherCAT

ABB's AC500 PLC using EtherCAT real-time bus delivers high performance for multi-axis control applications.

The AC500 PLC provides an industry solution with IEC 61131-3 programming and PLCopen motion functions in combination with ABB drives such as ACS880-M04 fitted with the FECA-01 EtherCAT module for higher power axes or ACS380 drives or with MicroFlex e190.

This popular high-performance motion bus provides simple 'daisy chain' connection.

— EtherCAT multi-axis coordinated motion

— 01 AC500 PLC

— 02 CP600 HMI

— 03 Pluto Safety PLC module

— 04 MicroFlex e190

— 05 MotiFlex e180

— 06 ACS880-M04

— 07 ACS380

— 08 ACS880

— 09 S500 EtherCAT I/O

08

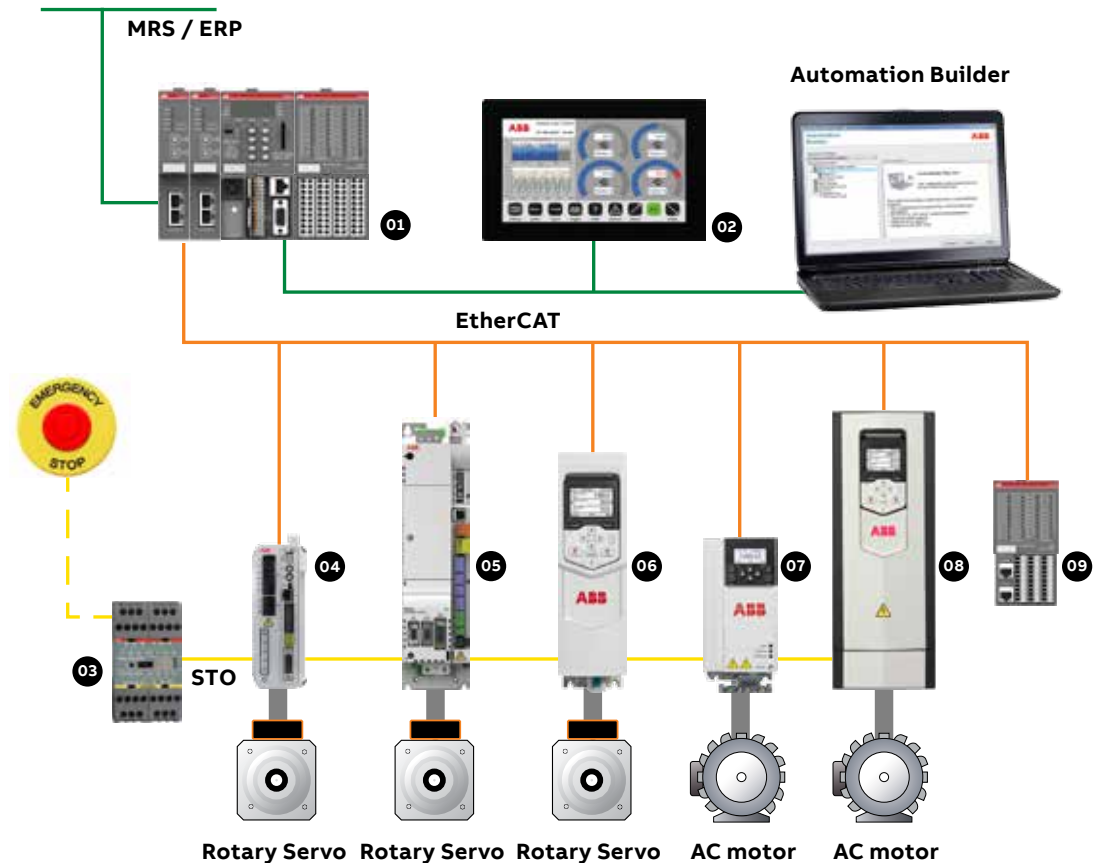

Rotary Servo Rotary Servo Rotary Servo AC motor AC motor

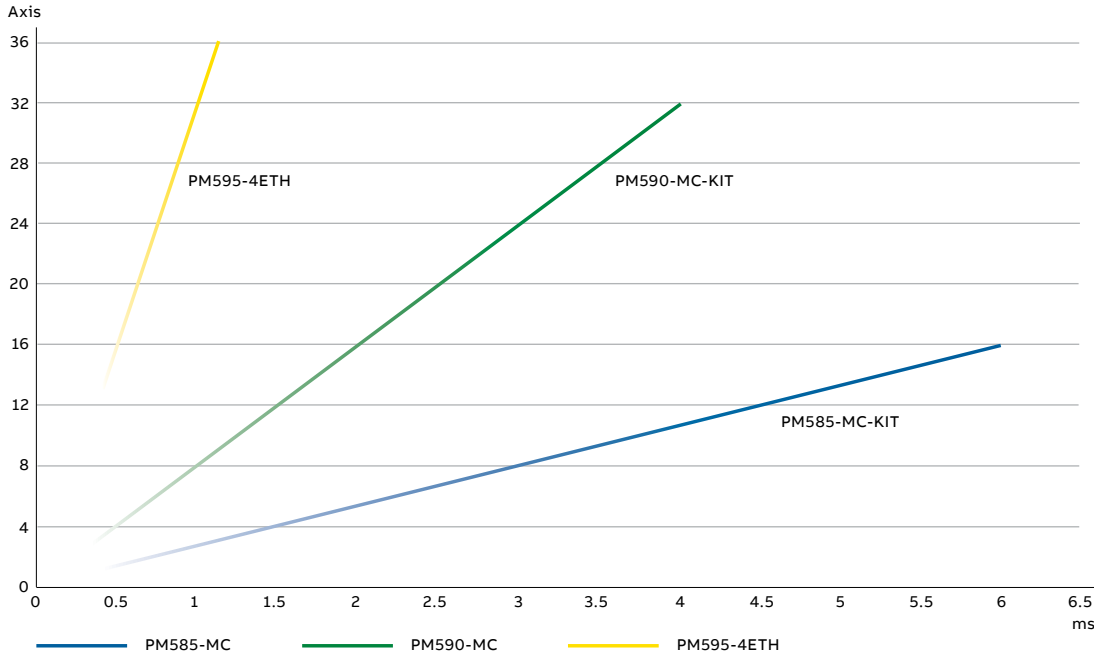

01

01 Number synchronized Axis / ms

EtherCAT AC500 machine controller kits

In order to simplify your application, ABB offers products for the implementation of machine control or motion control applications. These products can be purchased individually or as a kit.

Two available EtherCAT kits contain the components required for your application.

Depending on the required performance, the kit provides a powerful CPU, an EtherCAT master communication module and the respective terminal base.

The kit can be expanded using standard I/Os, other communication products or software solutions.

AC500 Machine controller kits

Program memory kB	Cycle time in μ s per instruction min. Bit/Word/Float. point	Integrated communication	Type	Order code	Price	Weight (1 pce) kg
1024	0.004 / 0.008 / 0.008	PM585-ETH, CM579-ETHCAT, TB511-ETH Ethernet (2), 2 x serial, EtherCAT Master	PM585-MC-KIT	1SAP140500R0379		0.500
2048	0.002 / 0.004 / 0.004	PM590-ETH, CM579-ETHCAT, TB521-ETH, TA524 Ethernet (2), 2 x serial, EtherCAT Master	PM590-MC-KIT	1SAP150000R0379		0.500

AC500 CPU PM595

Program memory MB	Cycle time in μ s per instruction min. Bit/Word/Float. point	Integrated communication	Type	Order code	Price	Weight (1 pce) kg
16	0.0006/0.001/0.001	2 x Ethernet (2 Ports switch), 2 x Ethernet (2), 2 x serial	PM595-4ETH-F	1SAP155500R0279		1.050

Application descriptions

Real-time Ethernet functionality

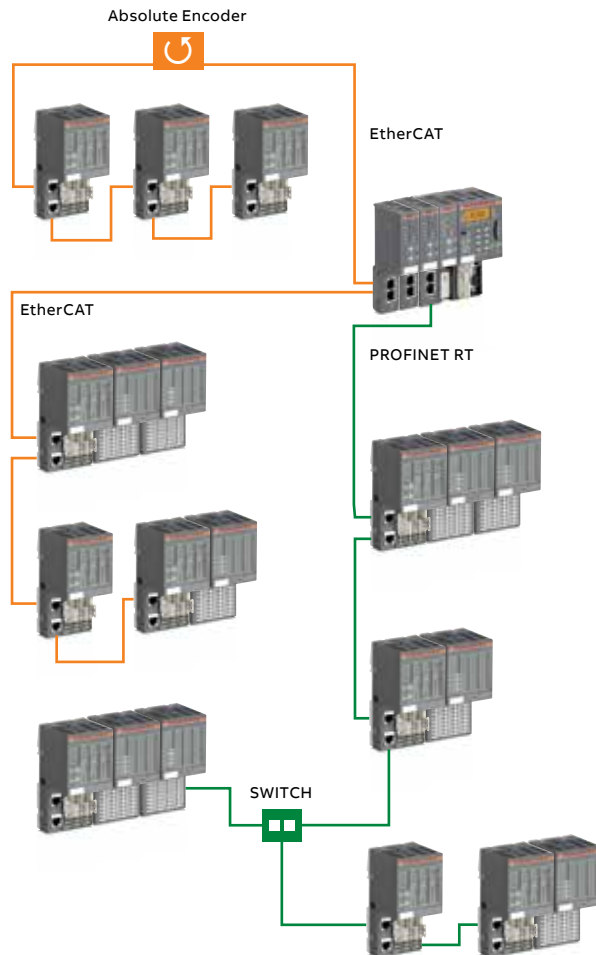

RT-Ethernet modules

Modules are available with two different communication protocols based on Ethernet (PROFINET I/O, EtherCAT). Master couplers connect AC500 CPUs to remote I/O modules. Various interface modules offer the connection of decentralized I/O modules to the real-time Ethernet networks.

Cam-switch functionality

Modules based on the decentralized real-time EtherCAT interface technology with integrated I/Os and programmed with PLCopen function blocks are available.



08

Application descriptions

Embedding safety I/Os in ABB robots enhances man-machine collaboration

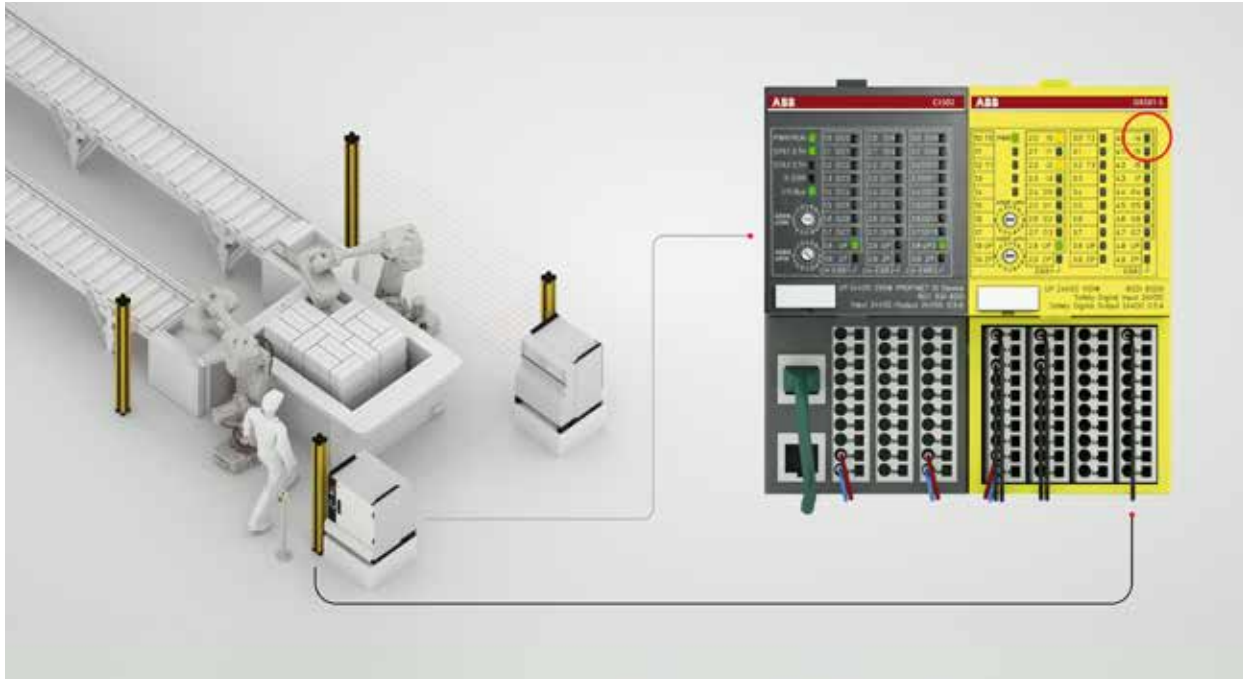

Integration of safety I/Os

ABB is embedding S500 safety I/Os within its series of robot controllers to improve the flexibility, safety and reliability of collaboration between robots and people, which prevents unnecessary disruption to production. Simply extend your control system with ABB S500 safety I/Os to save wiring efforts, operation costs and use unique features of our safety I/O portfolio to increase your machine productivity.

A light curtain, laser scanner, safety mat, E-stop and acknowledge button, for example, are connected to ABB's S500 safety I/O module, which is integral to the ABB robot controller. Should a human enter the robot's cell to undertake maintenance, the safely-limited speed of the robot can be triggered, if permitted, as opposed to a safe stop. The robot moves very slowly and within

the pre-defined safe work zone using ABB's SafeMove2. Once the human leaves the cell, the robot can resume its faster operational speed with or without acknowledgement, depending on the used safety sensors.

Cost-efficient solution

As the S500 safety I/Os are controlled by the safety module inside the robot controller, there is no need for third party stand-alone safety PLCs to be used. This saves costs as the combination of I/O and robot controller frees up space that would normally be needed for a separate cabinet. It also reduces the time associated with the set-up and operation of robotic production cells. This standardized solution leads to reduced spares, less wiring and lower operational costs as well as easy engineering through common diagnostics.

Enhanced functionality

- More test pulse outputs on S500 safety digital I/O modules ensure higher degree of fault diagnostics and reaction, which results in higher safety integrity level for safety functions in the machine.
- Each safety I/O channel has not only process state LED but also fault-diagnostic LED which significantly simplifies maintenance work and, thus, save your operation costs.
- Extreme condition (XC) modules are available (-40 to +70 °C, high vibration and shock requirements, etc.), which allows cost-savings in engineering and operation.
- Fool-proof protection implemented in all safety I/O modules (reverse signal or power supply polarity, wrong module placement, short circuit etc.), to avoid damaged modules due to wrong wiring.

More flexibility

- A single safety I/O channel can be individually reintegrated, which may provide higher machine availability in many customer cases.
- Front panel rotary switch for PROFIsafe address ensures less maintenance effort because you can see all pre-set PROFIsafe addresses directly looking at the front cover of safety I/O modules (no more need to disassemble safety I/Os).
- Built-in module power supply (no additional 24V DC power supply needed), which makes your power supply connections much simpler.

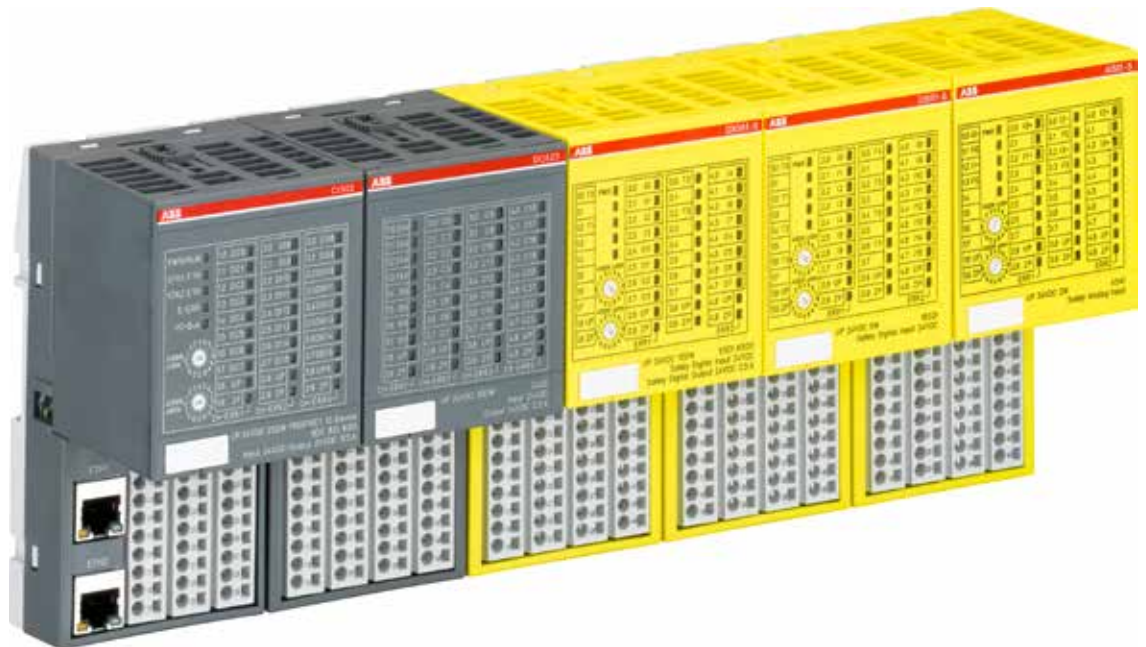

Application descriptions

Safe communication between safety CPUs

— 01 A modern distribution center comprises several independent systems including conveyor and lift systems, robotic sorting and palletizing processes, together with autonomous guided vehicles, or AGVs, and automated stacker cranes that lift pallets to and from the high bay storage systems. Each system needs to exchange its control and safety data via a central control system or distributed control system in an efficient and reliable manner so as to maintain productivity and minimize downtime.

Real-time exchange of high volume process and safety data

ABB has moved from using just one central PLC controller to that of multiple controllers capable of communicating with many machines in real-time. Now each machine controller can exchange big volumes of process and safety data in real-time to more than one central control system simultaneously.

New safety CPU modules that can now function as both a safety controller and a safety device are launched by ABB. The modules, when used with ABB's AC500/AC500-S Programmable Logic Controller (PLC), feature the ability to exchange process and safety data, not only from one controller to multiple devices but also from one device to multiple controllers, using PROFINET/PROFIsafe shared device functionality.

Now hybrid interconnected PLC control systems can extend traditional centralized or distributed control. As such, each controlled machine can deliver high volumes of process and safety data in real-time, simultaneously, to several central control systems.

This solution replaces gateways which are expensive, take valuable control cabinet space and because they are limited to only 12 bytes of safety data per gateway, cannot communicate in real-time with large safety data volumes. With the new solution, a maximum of 1440 bytes of process data including up to 384 bytes of functional safety data can be allocated for up to four PLC controller systems, thereby providing faster reaction to optimize the production and improve the predictive maintenance that leads to less downtime.

— 01

08

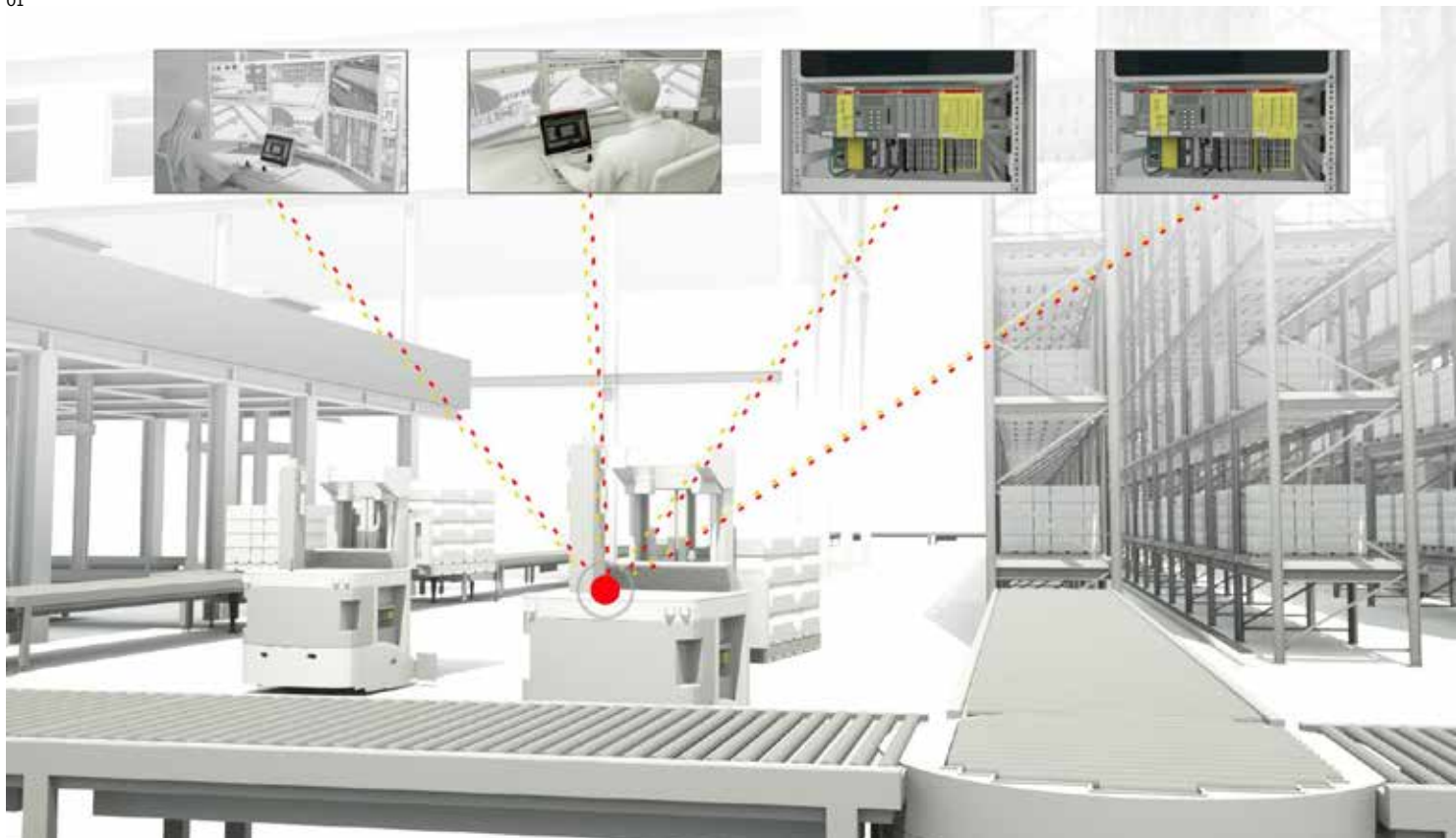

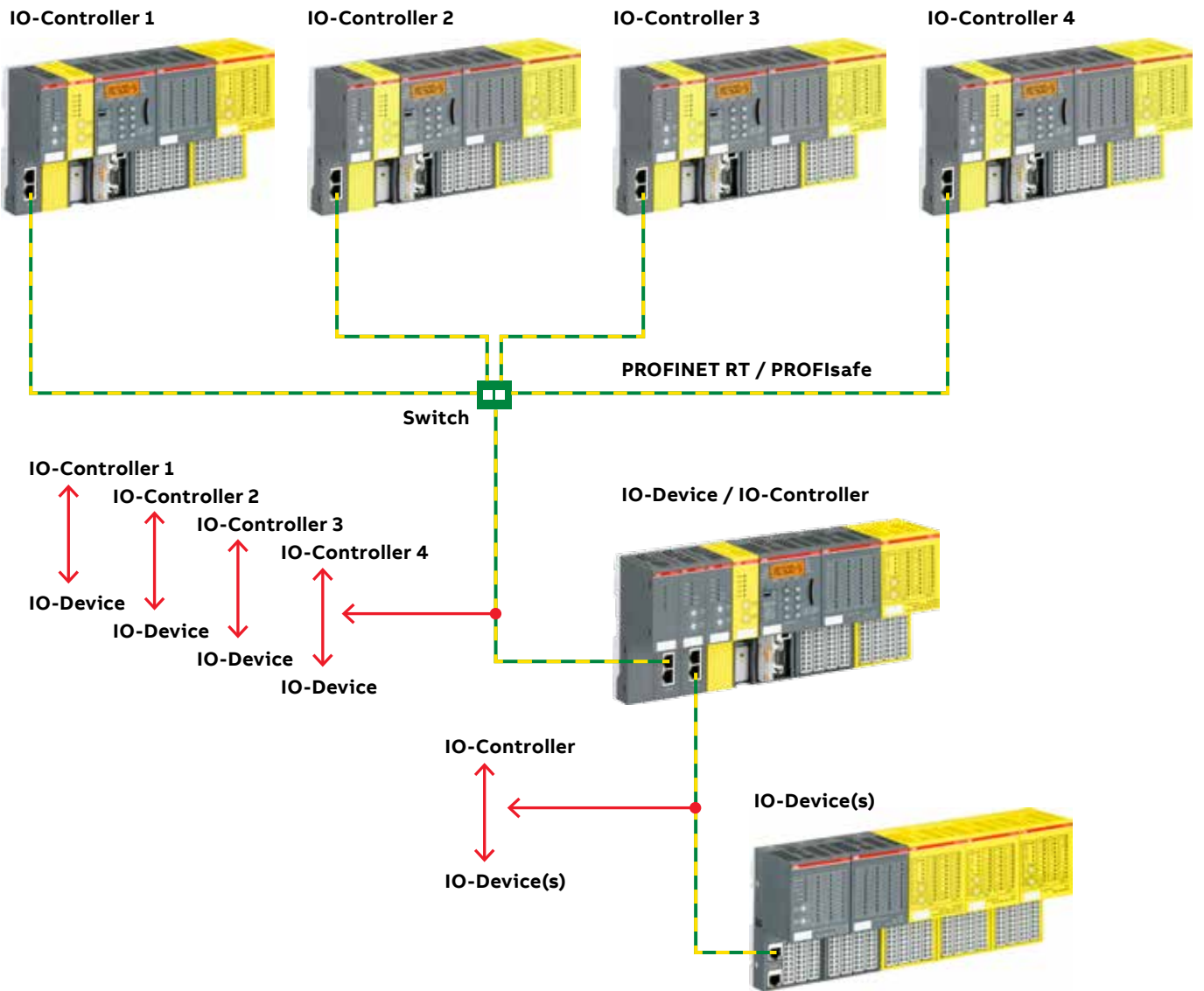

PLC training and support

ABB provides training and technical support guiding you to the ideal PLC Automation products for your applications.

—
01 AC500 basic and advanced training case
For details, please see page 87.

—
02 AC500-S training case
For details, please see page 170.

Supported by one of the world's most extensive global sales and service networks, we offer PLC and Automation Builder software training designed for engineering, operation and maintenance of PLC automation solutions. Learn online through our video tutorials, eLearning, application examples or user forum and attend our classroom training sessions.

For more information, please see www.new.abb.com/plc/training.



—
02



—
01

AC500-eCo Starter kit

Getting started is so simple

More functionality and enhanced scalability

AC500-eCo Starter kit

The AC500-eCo Starter kit helps you to get familiar with ABB AC500 PLC offerings and the engineering tool within a very short time. Learn how to connect and setup the components provided in the starter kit and how to program the PLC by means of several simple example applications. The starter kit comes with CPU, programming cable, digital input simulator and getting started manual. The latest version of the engineering tool Automation Builder is available via download. The getting started manual is integrated in Automation Builder.



Easy to use

The AC500-eCo from ABB is a range of uniquely scalable PLCs offering you unrivalled cost effectiveness for modern industrial automation applications. The AC500-eCo integrates perfectly into the AC500 family - this provides you with the option to build customized solutions based on the standard S500 and S500-eCo I/O range.

Easy to learn

Offering all of the advantages you would expect from the AC500 family of devices, the AC500-eCo delivers an impressive set of powerful programming features. In addition, thanks to the fact that ABB uses a standard IEC61131-3 based programming system for the entire AC500 family, it is a snap to learn and configure.

Ordering data

Each kit consists of CPU, programming cable and digital input simulator. The engineering tool is available for download at www.abb.com/automationbuilder.

CPU module in the starter kit	Programming cable (included)	Type	Order code	Price	Weight (1 pce) kg
PM554-TP-ETH	Ethernet	TA574-D-T-ETH	1SAP186200R0004		1.400

AC31 adapter for retrofitting existing AC31 applications

AC500 life cycle management protects your investment

A long history

During more than 40 years in the PLC business, we have gained experience from hardwired, centralized and distributed PLCs to scalable PLCs. One of our previous product ranges, the AC31 series 90, was succeeded by the AC500 PLC platform.

For the protection of your investments and for ease of migration to the new AC500 PLC generation, ABB provides AC31 adapter modules based on AC500.

The modules have the same footprint, cabling and features as the previous AC31 series 90 products with up-to-date AC500 hardware.

AC31 adapter modules can replace existing AC31 devices with either direct compatible e.g. I/O modules or need adjustments with a new user program for the CPU using Automation Builder software.

Main characteristics and architecture

The connection locations do not differ from the predecessor hardware and the number or type of I/O channels are comparable. For remote I/O products on the CS31 bus, I/Os of an existing field application can be modified without having to change the application or configuration. New modules can be configured with DIP switches.

Replacing the AC31 PLC with the 07KT98-x-AD PLC requires only minor program modifications using the Automation Builder engineering suite.

Advantages at a glance

- Compatible with the existing AC31 series 90 remote I/O-modules, optionally with 1-to-1 replacement in the field, no change of application configuration required.
- Footprint identical to predecessor hardware.
- Automation Builder for PLC programming.
- Standard AC500 modules for seamless migration from AC31 to the new AC500.
- Longer life cycle of AC31 through migration to new solution.

Ordering details

Please contact your local sales organization.



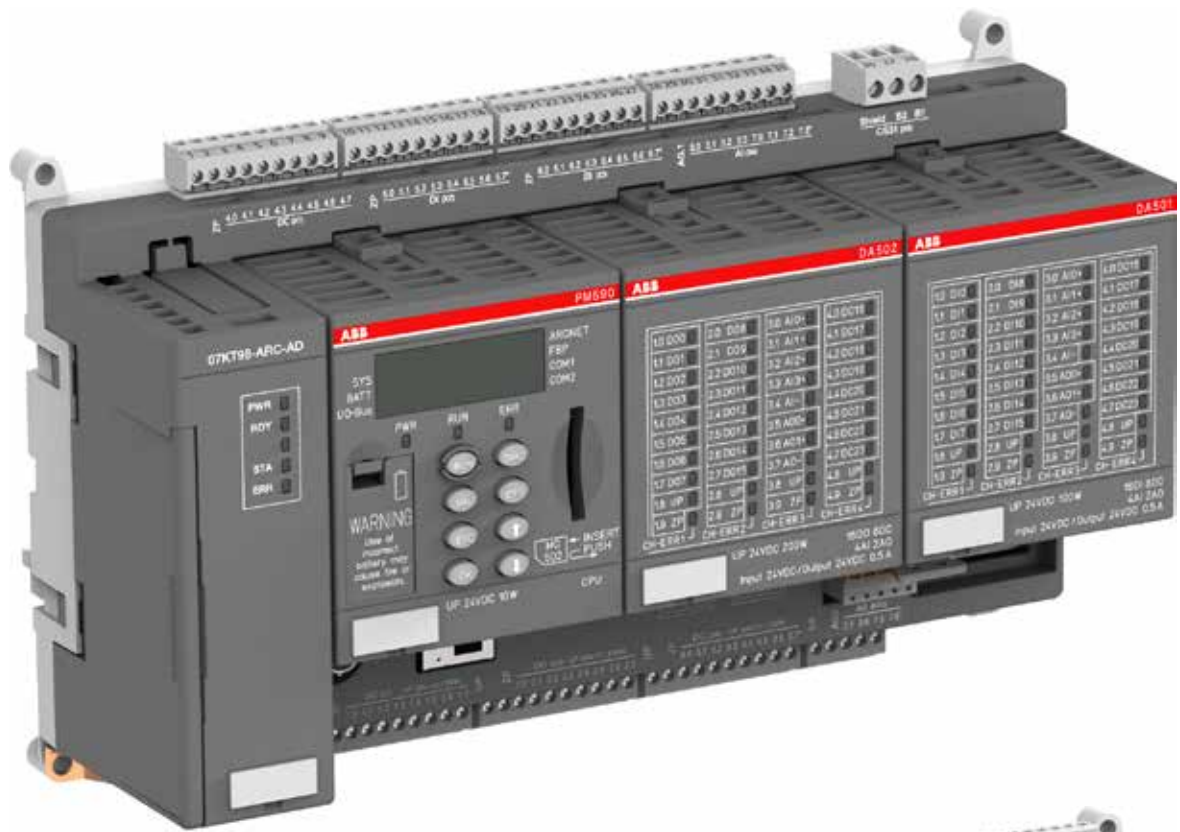

Additional information

Services



Order and delivery

Orders can be placed at any ABB office or channel partner. In some countries, ABB also offers an on-line order tracking system. ABB's sales and service network ensures timely deliveries and also offers express delivery.

Installation and commissioning

While many customers have the resources to perform installation and commissioning on their own, ABB and its channel partners offer professional installation and start-up services.

Operation and maintenance

From maintenance assessments, preventive maintenance, reconditioning of spare parts and repairs on-site or in workshops, ABB has all the options covered to keep their customers' processes operational.

Upgrade and retrofit

Frequently, ABB products can often be upgraded to the latest software or hardware in order to improve the performance of the application. Existing processes can be economically modernized by retrofitting with up-to-date technology.

Replacement and recycling

ABB provides assistance in the best replacement of products while ensuring disposal and recycling observing the local environmental regulations.

Services offered for ABB's automation products span the entire asset lifetime, from the moment a customer makes the first inquiry to disposal and recycling of the product. Throughout the life cycle of an asset, ABB provides training, technical support and customized contracts, supported by one of the world's most extensive global sales and service networks.

Pre-purchase

ABB provides a range of services and support guiding the customers to the ideal products for their applications.

Additional information

Life cycle management for maximum return on investment

Product life cycle management model



ABB has developed a PLC life cycle management model aimed at providing proactive services for maximizing availability and performance. This model not only provides optimum support to end-users but also a smooth transition to a new product when the PLC has come to the end of its lifetime.

The life cycle management model divides a product's life cycle into four phases: active, classic, limited and obsolete. Each phase has different implications for the end-user in terms of services provided.

Active phase

The active phase starts when the product is launched. In the active phase the end user benefits from different warranty options and other services such as training and technical support. Complete life cycle services from spare parts and maintenance are also provided. The active phase ends when the volume production of a particular PLC ceases and ABB issues an announcement of the life cycle phase change.

Classic phase

ABB PLC users continue to benefit from complete life cycle services throughout the classic phase. The classic phase is closely aligned with ABB's research and development work to provide continuing support for its PLC products while developing future generations. In the classic phase new hardware and software development may be required to provide the maintenance techniques and upgrades needed to guarantee that the PLC continues to operate at its peak performance. Migration to a new PLC product is recommended before the product has entered the limited phase.

Limited phase

In the limited phase the product development has come to its end. Spare parts are available as long as components and materials can be obtained. Towards the end of the limited phase, services gradually become obsolete. In addition to the annual life cycle status reviews, ABB issues a life cycle phase change announcement, half a year prior the product becoming obsolete. This is the last opportunity to transfer to new technology before product services end.

Obsolete phase

The product is transferred to the obsolete phase when it is no longer possible to provide services at reasonable cost or when ABB can no longer support the product technically or the old technology is not available.

Benefits of life cycle management

PLC life cycle management maximizes the value of the equipment and its maintenance investments by:

- ensuring spare parts and ABB competence availability throughout the lifetime
- enabling efficient product support and maintenance for improved reliability
- adding functionality to the initial product by upgrading or retrofitting
- providing a smooth transition to new technology at the end of the product lifetime.

For more information, please see www.abb.com/plc.

Additional information

Automation Builder product life cycle plan

Product life cycle

ABB is committed to support our customers' installed system base. We want to optimize our customers' system investment and provide our customers with the confidence that there is a well-defined support and a path forward for existing ABB systems. ABB's product life cycle policy provides advanced notification of planned changes in product availability and support.

This chapter shall not be understood as legally binding. Users are recommended to keep informed about updates by periodically checking relevant life cycle information.

Predictive releases – continuous delivery

ABB continuously maintains and improves its software products. As part of this effort, we develop and release major versions, minor version and service releases.

Major and minor releases focus on new features whereas service releases deliver corrections and quality improvements. A new service release supersedes and replaces existing service releases within the same major/minor release. All releases contain corrections to issues identified both in ABB test labs as well as reported by our customers.

Release Type	Designation example	Purpose and frequency
Major Release	1.x, 2.x	Deliver new features extending Automation Builder scope
Minor Releases	1.1.x, 1.2.x	Deliver new features within current Automation Builder scope
Service Releases	1.2.1, 1.2.2	Deliver corrections, improvements and updates of existing components

ABB aims for continuous, consistent and coordinated delivery of engineering tool versions and device firmware versions. It is recommended to always use the latest release of Automation Builder.

Version profiles – compatibility with installed base

ABB aims on maximizing availability and performance of the installed base. In this effort we follow these two principles: The engineering tool shall provide the latest features in best quality. The engineering tool and installed base shall always be compatible.

To meet these requirements Automation Builder introduced version profiles. A version profile contains all Automation Builder software components as released in the latest service release of a specific major/minor version, including respective device firmware versions.

Version profiles can be installed with every release of Automation Builder. Multiple version profiles can be installed in parallel. Each version profile goes through all product life cycle phases. Life cycle statements apply for each version profile and corresponding licenses. The availability of a version profile depends on the life cycle phase it is currently in.

All this allows our users to install the latest version of Automation Builder and keep compatibility with the installed base. Updates of the runtime system are avoided. Latest Automation Builder release always contains the best quality for all profiles. Corrections are distributed via releases and not via hard to track patches.

Automation Builder life cycle management model

The Automation Builder life cycle management model aims to provide service for maximizing availability and performance, support to end-users and a smooth transition to new product versions when the service life of the current product ends. The model divides a product's life cycle into four phases: active, classic, limited and obsolete. Each phase has different implications for the end-user in terms of software and license availability, services and support provided.

Active	The software product with complete life cycle services is available.
Classic	The software product with complete life cycle services is available for system extensions and spare part engineering.
Limited	The software product is available without maintenance and further corrections. Migration to a newer version is recommended.
Obsolete	Migration to a newer version is recommended.

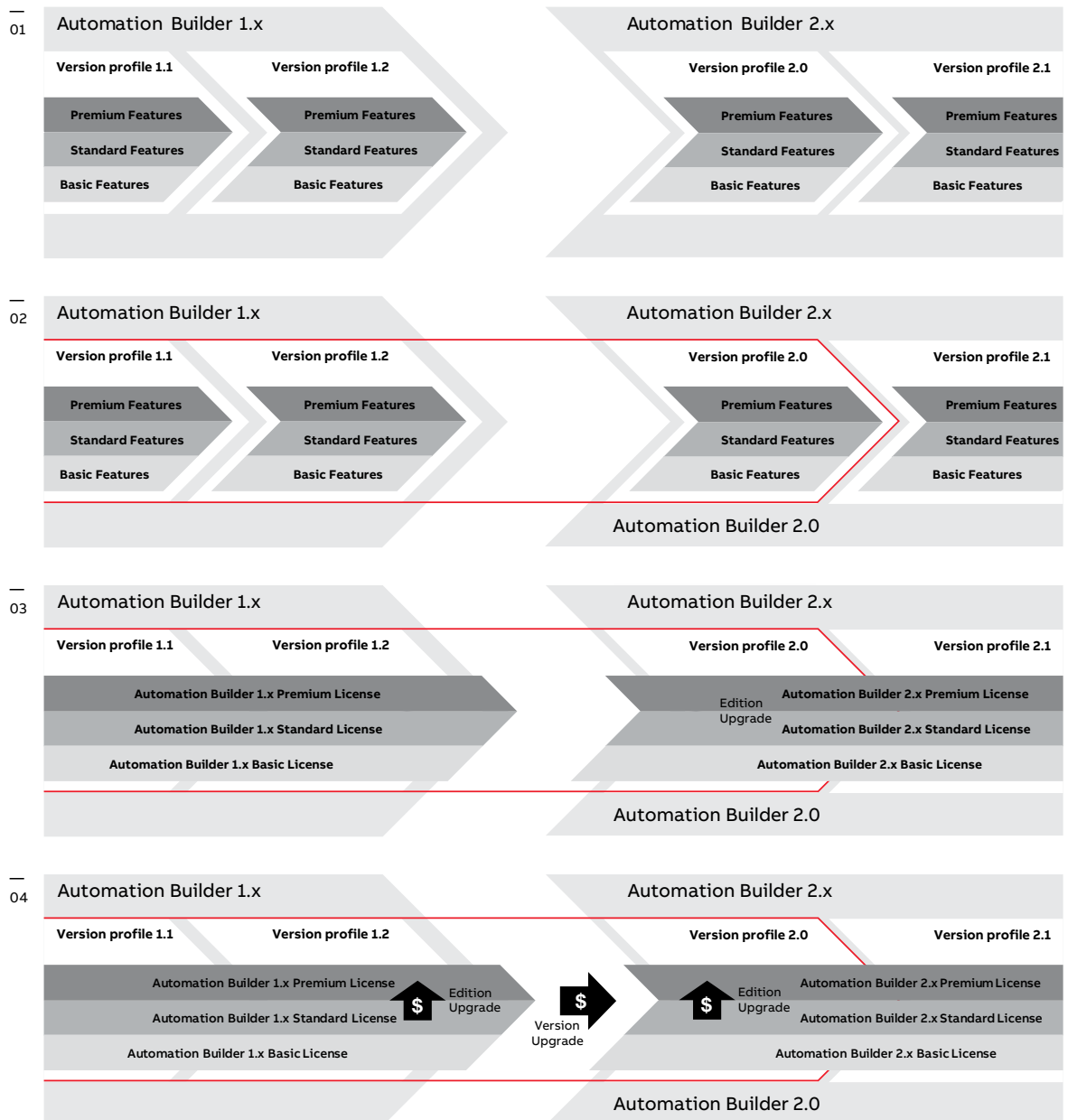

Version profiles and licenses

01 – Major versions come in several minor versions, e.g. Automation Builder 1.x comes as Automation Builder 1.1 and 1.2. Version profiles cover different sets of features, e.g. basic, standard and premium feature sets.

02 – An Automation Builder release contains multiple version profiles, each corresponding to a released minor version. E.g. release Automation Builder 2.0 contains version profile 2.0, 1.2, 1.1 and more.

03 – To use a feature a license is required. The license defines which feature set can be used, e.g. a premium license enables you to use the premium feature set. A license corresponds to a major version of Automation Builder, e.g.

Automation Builder 2.x Premium license enables to use Premium features in all 2.x minor versions and in all previous versions.

04 – There are two different cases where you have to purchase a new Automation Builder license:

- Edition upgrade: Commercial upgrade from one license option to a higher value license option within the same major version of Automation Builder, e.g. Automation Builder 1.x Standard to Premium.
- Version upgrade: Commercial upgrade from one major Automation Builder version to another, e.g. Automation Builder 1.x to 2.x. – Note: Licenses for Automation Builder 1.x and Automation Builder 2.x can be used in parallel in order to support different version profiles.

Additional information

Automation Builder product life cycle plan

Life cycle phases

Active

A newly released version profile of Automation Builder starts in life cycle phase Active. During the Active phase the version profile is available with complete life cycle services.

This means the version profile is available via Automation Builder installation manager from abb.com and will receive ABB's normal product maintenance including enhancements and corrections, and third party software updates.

The version is the base for current sales and active price list. Licenses can be purchased. Support and training is provided.

Classic

With release of the next major/minor version the predecesing version profile is going into life cycle phase Classic. During the Classic phase, the version profile with complete life cycle services is available for system extensions and spare part engineering.

Classic version profiles are available via Automation Builder installation manager from abb.com and will receive corrections only for critical issues. Classic version profiles are typically available as released in the latest respective service release (and additional corrections). New 3rd party products (e.g. OS) are not supported anymore.

Licenses can be purchased (some exceptions apply – see “Classic-Limited”). Training is not available anymore. Support is provided.

Classic-Limited

The Classic-Limited phase corresponds to the Classic phase with the following limitations: Corrections might be available upon request as billable service. Licenses are typically not available anymore but might be available upon request as spare part.

Limited

During the Limited phase, the version profile is available without maintenance and further corrections. Migration to a newer version is recommended.

This means it is no longer available from Automation Builder installation manager from abb.com, but could be obtained as offline installations via support. Corrections might be available upon request as billable service. New 3rd party products (e.g. OS) are not supported anymore.

Licenses are typically not available anymore but might be available upon request as spare part. Training is not available anymore. Support is provided.

Obsolete

When entering the Obsolete phase, the version profile is not supported anymore. Migration to a newer version is strongly recommended.

This means it is not available anymore for installation. It will not receive corrections anymore.

Licenses are not available for purchase anymore. Training is not available anymore. Support is not available anymore.

Additional information

Approvals and certifications

Symbols and legends:

- Standard product certified: product label wears approval mark when mandatory
- ◐ Approval submitted (roadmap available upon request)
- Submission planned (roadmap available upon request)
- Submission not planned or not applicable for product

Symbol	Approvals							Maritime classification companies							
Abbreviation	CE	RoHS	China RoHS	RCM	EAC	KCC	cULus		ABS	BV	DNV GL	LR	RINA	RMRS	EU
Name							Ordinary Locations	Hazardous Locations							Mutual Recognition
AI523	●	●	●	●	●	●	●	●	●	●	●	●	●	●	○
AI523-XC	●	●	●	●	●	●	●	●	●	●	●	●	●	●	○
AI531	●	●	●	●	●	●	●	●	●	●	●	●	●	-	○
AI531-XC	●	●	●	●	●	●	●	●	●	●	●	●	●	-	○
AI561	●	●	●	●	●	●	●	●	●	-	●	●	●	●	○
AI562	●	●	●	●	●	●	●	●	●	-	●	●	●	●	○
AI563	●	●	●	●	●	●	●	●	●	-	●	●	●	●	○
AI581-S	●	●	●	●	●	●	●	●	●	●	●	●	●	●	○
AI581-S-XC	●	●	●	●	●	○	●	●	●	●	●	●	●	●	○
AO523	●	●	●	●	●	●	●	●	●	●	●	●	●	●	○
AO523-XC	●	●	●	●	●	●	●	●	●	●	●	●	●	●	○
AO561	●	●	●	●	●	●	●	●	●	-	●	●	●	●	○
AX521	●	●	●	●	●	●	●	●	●	●	●	●	●	●	○
AX521-XC	●	●	●	●	●	●	●	●	●	●	●	●	●	●	○
AX522	●	●	●	●	●	●	●	●	●	●	●	●	●	●	○
AX522-XC	●	●	●	●	●	●	●	●	●	●	●	●	●	●	○
AX561	●	●	●	●	●	●	●	●	●	-	●	●	●	●	○
CD522	●	●	●	●	●	●	●	●	●	●	●	●	●	●	○
CD522-XC	●	●	●	●	●	●	●	●	●	●	●	●	●	●	○
CI501-PNIO	●	●	●	●	●	●	●	●	●	●	●	●	●	●	○
CI501-PNIO-XC	●	●	●	●	●	●	●	●	●	●	●	●	●	●	○
CI502-PNIO	●	●	●	●	●	●	●	●	●	●	●	●	●	●	○
CI502-PNIO-XC	●	●	●	●	●	●	●	●	●	●	●	●	●	●	○
CI504-PNIO	●	●	●	●	●	●	●	●	●	●	●	●	●	●	○
CI504-PNIO-XC	●	●	●	●	●	●	●	●	●	●	●	●	●	●	○
CI506-PNIO	●	●	●	●	●	●	●	●	●	●	●	●	●	●	○
CI506-PNIO-XC	●	●	●	●	●	●	●	●	●	●	●	●	●	●	○
CI511-ETHCAT	●	●	●	●	●	●	●	●	●	●	●	●	●	●	○
CI512-ETHCAT	●	●	●	●	●	●	●	●	●	●	●	●	●	●	○
CI521-MODTCP	●	●	●	●	●	○	●	●	-	-	-	-	-	-	○
CI521-MODTCP-XC	●	●	●	●	●	○	●	●	-	-	-	-	-	-	○
CI522-MODTCP	●	●	●	●	●	○	●	●	-	-	-	-	-	-	○
CI522-MODTCP-XC	●	●	●	●	●	○	●	●	-	-	-	-	-	-	○
CI541-DP	●	●	●	●	●	●	●	●	●	●	●	●	●	●	○
CI541-DP-XC	●	●	●	●	●	●	●	●	●	●	●	●	●	●	○
CI542-DP	●	●	●	●	●	●	●	●	●	●	●	●	●	●	○
CI542-DP-XC	●	●	●	●	●	●	●	●	●	●	●	●	●	●	○
CI581-CN	●	●	●	●	●	●	●	●	●	●	●	●	●	●	○
CI581-CN-XC	●	●	●	●	●	●	●	●	●	●	●	●	●	●	○
CI582-CN	●	●	●	●	●	●	●	●	●	●	●	●	●	●	○
CI582-CN-XC	●	●	●	●	●	●	●	●	●	●	●	●	●	●	○

- Symbols and legends:
- Standard product certified; product label wears approval mark when mandatory
 - Approval submitted (roadmap available upon request)
 - Submission planned (roadmap available upon request)
 - Submission not planned or not applicable for product

Symbol	Approvals							Maritime classification companies							EU
Abbreviation	CE	RoHS	China RoHS	RCM	EAC	KCC	cULus		ABS	BV	DNV GL	LR	RINA	RMRS	EU
Name							Ordinary Locations	Hazardous Locations							Mutual Recognition
CI590-CS31-HA	●	●	●	●	●	●	●	●	●	●	●	●	●	●	○
CI590-CS31-HA-XC	●	●	●	●	●	●	●	●	●	●	●	●	●	●	○
CI592-CS31	●	●	●	●	●	●	●	●	●	●	●	●	●	●	○
CI592-CS31-XC	●	●	●	●	●	●	●	●	●	●	●	●	●	●	○
CM572-DP	●	●	●	●	●	●	●	●	●	●	●	●	●	●	○
CM572-DP-XC	●	●	●	●	●	●	●	●	●	●	●	●	●	●	○
CM574-RCOM	●	●	●	●	●	●	●	●	●	●	●	●	●	●	○
CM574-RS	●	●	●	●	●	●	●	●	●	●	●	●	●	●	○
CM578-CN	●	●	●	●	●	●	●	●	●	●	●	●	●	●	○
CM578-CN-XC	●	●	●	●	●	●	●	●	●	●	●	●	●	●	○
CM579-ETHCAT	●	●	●	●	●	●	●	●	●	●	●	●	●	●	○
CM579-PNIO	●	●	●	●	●	●	●	●	●	●	●	●	●	●	○
CM579-PNIO-XC	●	●	●	●	●	●	●	●	●	●	●	●	●	●	○
CM582-DP	●	●	●	○	○	○	●	●	-	-	-	-	-	-	○
CM582-DP-XC	●	●	●	○	○	○	●	●	-	-	-	-	-	-	○
CM588-CN	●	●	●	●	●	●	●	●	●	●	●	●	●	●	○
CM588-CN-XC	●	●	●	●	●	●	●	●	●	●	●	●	●	●	○
CM589-PNIO	●	●	○	○	○	-	●	●	●	○	●	●	●	○	○
CM589-PNIO-4	●	●	○	○	○	-	●	●	●	○	●	●	-	○	○
CM589-PNIO-4-XC	●	●	○	○	○	-	●	●	●	○	●	●	-	○	○
CM589-PNIO-XC	●	●	○	○	○	-	●	●	●	○	●	●	●	○	○
CM592-DP	●	●	●	○	○	-	●	●	●	○	●	●	●	○	○
CM592-DP-XC	●	●	●	○	○	-	●	●	●	○	●	●	●	○	○
CM597-ETH	●	●	●	●	●	-	●	●	●	○	●	●	●	○	○
CM597-ETH-XC	●	●	●	●	○	-	●	●	●	○	●	●	●	○	○
CM598-CN	●	●	●	○	○	-	●	●	●	○	●	●	●	○	○
CM598-CN-XC	●	●	●	○	○	-	●	●	●	○	●	●	●	○	○
CP604	●	●	○		○	-	●	-	-	-	-	-	-	-	○
CP604-B	●	●	○		○	-	●	-	-	-	-	-	-	-	○
CP607	●	●	○		○	-	●	-	-	-	-	-	-	-	○
CP607-B	●	●	○		○	-	●	-	-	-	-	-	-	-	○
CP610	●	●	○		○	-	●	-	-	-	-	-	-	-	○
CP610-B	●	●	○		○	-	●	-	-	-	-	-	-	-	○
CP620	●	●	○		●	●	●	●	-	-	○	-	-	-	-
CP620-WEB	●	●	○		●	●	●	●	-	-	○	-	-	-	-
CP630	●	●	○		●	●	●	●	-	-	○	-	-	-	-
CP630-WEB	●	●	○		●	●	●	●	-	-	○	-	-	-	-
CP635	●	●	○	●	●	●	●	●	-	-	○	-	-	-	-
CP635-B	●	●	○	○	○	○	●	●	-	-	○	-	-	-	-
CP635-FB	●	●	○	○	○	○	●	-	-	-	○	-	-	-	-
CP635-FW	●	●	○	○	○	○	●	-	-	-	○	-	-	-	-
CP635-WEB	●	●	○	●	●	●	●	●	-	-	○	-	-	-	-
CP651	●	●	○	○	●	○	●	●	-	-	○	-	-	-	-
CP651-WEB	●	●	○	○	●	○	●	●	-	-	○	-	-	-	-
CP6605	○	○	○	○	○	○	○	○	-	-	-	-	-	-	○
CP6607	○	○	○	○	○	○	○	○	-	-	-	-	-	-	○
CP661	●	●	○	○	○	○	●	●	-	-	○	-	-	-	-
CP6610	○	○	○	○	○	○	○	○	-	-	-	-	-	-	○
CP6615	○	○	○	○	○	○	○	○	-	-	-	-	-	-	○

Additional information

Approvals and certifications

Symbols and legends:

- Standard product certified: product label wears approval mark when mandatory
- ◐ Approval submitted (roadmap available upon request)
- Submission planned (roadmap available upon request)
- Submission not planned or not applicable for product

Symbol	Approvals							Maritime classification companies							EU
Abbreviation	CE	RoHS	China RoHS	RCM	EAC	KCC	cULus		ABS	BV	DNV GL	LR	RINA	RMRS	EU
Name							Ordinary Locations	Hazardous Locations							Mutual Recognition
CP661-WEB	●	●	◐	○	○	○	●	●	-	-	◐	-	-	-	-
CP6621	○	○	○	○	○	○	○	○	-	-	-	-	-	-	○
CP665	●	●	◐	○	○	○	●	●	-	-	◐	-	-	-	-
CP665-WEB	●	●	◐	○	○	○	●	●	-	-	◐	-	-	-	-
CP676	●	●	◐	○	●	○	●	●	-	-	◐	-	-	-	-
CP676-WEB	●	●	◐	○	●	○	●	●	-	-	◐	-	-	-	-
DA501	●	●	●	●	●	●	●	●	●	●	●	●	●	●	○
DA501-XC	●	●	●	●	●	●	●	●	●	●	●	●	●	●	○
DC522	●	●	●	●	●	●	●	●	●	●	●	●	●	●	○
DC522-XC	●	●	●	●	●	●	●	●	●	●	●	●	●	●	○
DC523	●	●	●	●	●	●	●	●	●	●	●	●	●	●	○
DC523-XC	●	●	●	●	●	●	●	●	●	●	●	●	●	●	○
DC532	●	●	●	●	●	●	●	●	●	●	●	●	●	●	○
DC532-XC	●	●	●	●	●	●	●	●	●	●	●	●	●	●	○
DC541-CM	●	●	●	●	●	●	●	●	●	●	●	●	●	-	○
DC541-CM-XC	●	●	●	●	●	●	●	●	●	●	●	●	●	-	○
DC551-CS31	●	●	●	●	●	●	●	●	●	●	●	●	●	●	○
DC551-CS31-XC	●	●	●	●	●	●	●	●	●	●	●	●	●	●	○
DC561	●	●	●	●	●	●	●	●	●	-	●	●	●	●	○
DC562	●	●	●	●	●	○	●	●	●	-	●	●	●	○	○
DI524	●	●	●	●	●	●	●	●	●	●	●	●	●	●	○
DI524-XC	●	●	●	●	●	●	●	●	●	●	●	●	●	●	○
DI561	●	●	●	●	●	●	●	●	●	-	●	●	●	●	○
DI562	●	●	●	●	●	●	●	●	●	-	●	●	●	●	○
DI571	●	●	●	●	●	●	●	●	●	-	●	●	●	●	○
DI572	●	●	●	●	○	○	●	●	●	-	●	●	●	○	○
DI581-S	●	●	●	●	●	●	●	●	●	●	●	●	●	●	○
DI581-S-XC	●	●	●	●	●	○	●	●	●	●	●	●	●	●	○
DO524	●	●	●	○	●	○	●	●	●	○	●	●	●	○	○
DO524-XC	●	●	●	○	●	○	●	●	●	○	●	●	●	○	○
DO526	●	●	●	○	○	○	○	○	-	-	-	-	-	-	○
DO526-XC	○	○	○	○	○	○	○	○	-	-	-	-	-	-	○
DO561	●	●	●	●	●	●	●	●	●	-	●	●	●	●	○
DO562	●	●	●	●	●	○	●	●	●	-	●	●	●	○	○
DO571	●	●	○	●	●	●	●	●	●	-	●	●	●	●	○
DO572	●	●	●	●	●	●	●	●	●	-	●	●	●	●	○
DO573	●	●	●	●	●	○	●	●	●	-	●	●	●	○	○
DX522	●	●	●	●	●	●	●	●	●	●	●	●	●	●	○
DX522-XC	●	●	●	●	●	●	●	●	●	●	●	●	●	●	○
DX531	●	●	●	●	●	●	●	●	●	●	●	●	●	●	○
DX561	●	●	●	●	●	●	●	●	●	-	●	●	●	●	○

Symbols and legends: ● Standard product certified; product label wears approval mark when mandatory
 ○ Approval submitted (roadmap available upon request)
 ○ Submission planned (roadmap available upon request)
 – Submission not planned or not applicable for product

Symbol	Approvals							Maritime classification companies							EU
Abbreviation	CE	RoHS	China RoHS	RCM	EAC	KCC	cULus		ABS	BV	DNV GL	LR	RINA	RMRS	EU
Name							Ordinary Locations	Hazardous Locations							Mutual Recognition
DX571	●	●	●	●	●	●	●	●	●	-	●	●	●	●	○
DX581-S	●	●	●	●	●	●	●	●	●	●	●	●	●	●	○
DX581-S-XC	●	●	●	●	●	○	●	●	●	●	●	●	●	●	○
FM502-CMS	●	●	●	○	●	●	●	●	●	○	●	●	●	○	○
FM502-CMS-XC	●	●	●	○	●	●	●	●	●	○	●	●	●	○	○
FM562	●	●	●	●	●	○	●	●	●	-	●	●	●	○	○
MC502	-	●	●	-	●	-	●	●	●	●	●	●	●	●	○
MC503	●	●	●	●	●	●	●	●	●	-	●	●	●	●	○
PM554-RP	●	●	●	●	●	○	●	●	●	-	●	●	●	●	○
PM554-RP-AC	●	●	●	●	●	○	●	●	●	-	●	●	●	●	○
PM554-TP	●	●	●	●	●	○	●	●	●	-	●	●	●	●	○
PM554-TP-ETH	●	●	●	●	●	○	●	●	●	-	●	●	●	●	○
PM556-TP-ETH	●	●	●	●	●	○	●	●	●	-	●	●	●	●	○
PM5630-2ETH	○	○	○	○	○	○	○	○	-	-	-	-	-	-	○
PM5630-2ETH-XC	○	○	○	○	○	○	○	○	-	-	-	-	-	-	○
PM564-RP	●	●	●	●	●	○	●	●	●	-	●	●	●	●	○
PM564-RP-AC	●	●	●	●	●	○	●	●	●	-	●	●	●	●	○
PM564-RP-ETH	●	●	●	●	●	○	●	●	●	-	●	●	●	●	○
PM564-RP-ETH-AC	●	●	●	●	●	○	●	●	●	-	●	●	●	●	○
PM564-TP	●	●	●	●	●	○	●	●	●	-	●	●	●	●	○
PM564-TP-ETH	●	●	●	●	●	○	●	●	●	-	●	●	●	●	○
PM5650-2ETH	●	●	●	○	○	○	●	○	-	-	-	-	-	-	○
PM5650-2ETH-XC	○	○	○	○	○	○	○	○	-	-	-	-	-	-	○
PM566-TP-ETH	●	●	●	●	○	○	●	●	●	-	●	●	●	○	○
PM5670-2ETH	○	○	○	○	○	○	○	○	-	-	-	-	-	-	○
PM5670-2ETH-XC	○	○	○	○	○	○	○	○	-	-	-	-	-	-	○
PM5671-2ETH	○	○	○	○	○	○	○	○	-	-	-	-	-	-	○
PM5675-2ETH	○	○	○	○	○	○	○	○	-	-	-	-	-	-	○
PM5675-2ETH-XC	○	○	○	○	○	○	○	○	-	-	-	-	-	-	○
PM572	●	●	●	●	●	●	●	●	●	●	●	●	●	●	○
PM573-ETH	●	●	●	●	●	●	●	●	●	●	●	●	●	●	○
PM573-ETH-XC	●	●	●	●	●	●	●	●	●	●	●	●	●	●	○
PM582	●	●	●	●	●	●	●	●	●	●	●	●	●	●	○
PM582-XC	●	●	●	●	●	●	●	●	-	-	●	●	●	●	○
PM583-ETH	●	●	●	●	●	●	●	●	●	●	●	●	●	●	○
PM583-ETH-XC	●	●	●	●	●	●	●	●	-	●	●	●	●	●	○
PM585-ETH	●	●	●	○	○	○	●	○	-	-	-	-	-	-	○
PM590-ARCNET	●	●	●	●	●	●	●	●	●	●	●	●	●	●	○
PM590-ETH	●	●	●	●	●	●	●	●	●	●	●	●	●	●	○
PM591-2ETH	●	●	●	●	●	○	●	○	●	○	●	●	●	○	○
PM591-ETH	●	●	●	●	●	●	●	●	●	●	●	●	●	●	○
PM591-ETH-XC	●	●	●	●	●	●	●	●	●	●	●	●	●	●	○
PM592-ETH	●	●	●	●	●	●	●	●	●	●	●	●	●	●	○
PM592-ETH-XC	●	●	●	●	●	●	●	●	●	●	●	●	●	●	○
PM595-4ETH-F	●	●	●	○	●	○	●	●	●	○	●	●	●	○	○
PM595-4ETH-M-XC	●	●	●	○	●	○	●	●	●	○	●	●	●	○	○
SM560-S	●	●	●	●	●	●	●	●	●	●	●	●	●	●	○
SM560-S-FD-1	●	●	●	○	○	○	●	●	-	-	-	-	-	-	○
SM560-S-FD-1-XC	●	●	●	○	○	○	●	●	-	-	-	-	-	-	○

Additional information

Approvals and certifications

Symbols and legends:

- Standard product certified: product label wears approval mark when mandatory
- ◐ Approval submitted (roadmap available upon request)
- Submission planned (roadmap available upon request)
- Submission not planned or not applicable for product

Symbol	Approvals							Maritime classification companies							
Abbreviation	CE	RoHS	China RoHS	RCM	EAC	KCC	cULus		ABS	BV	DNV GL	LR	RINA	RMRS	EU
Name							Ordinary Locations	Hazardous Locations							Mutual Recognition
SM560-S-FD-4	●	●	●	○	○	○	●	●	-	-	-	-	-	-	○
SM560-S-FD-4-XC	●	●	●	○	○	○	●	●	-	-	-	-	-	-	○
SM560-S-XC	●	●	●	●	●	○	●	●	●	●	●	●	●	●	○
TA521	-	-	●	-	●	-	●	-	-	-	●	-	●	-	○
TA523	-	●	●	-	-	-	●	-	-	-	-	-	●	-	-
TA524	-	●	○	-	●	-	●	-	-	●	●	-	●	-	○
TA525	-	-	●	-	-	-	●	-	-	-	-	-	●	-	-
TA526	-	●	●	-	-	-	●	-	-	-	●	-	●	-	○
TA527	-	○	●	-	●	-	-	-	-	-	-	-	-	-	-
TA528	-	○	●	-	●	-	-	-	-	-	-	-	-	-	-
TA532	-	○	○	-	-	-	-	-	-	-	-	-	-	-	-
TA533	-	○	○	-	-	-	-	-	-	-	-	-	-	-	-
TA534	-	○	○	-	-	-	-	-	-	-	-	-	-	-	-
TA535	-	○	●	-	-	-	-	-	-	-	-	-	-	-	-
TA536	-	○	○	-	-	-	-	-	-	-	-	-	-	-	-
TA540	-	○	●	-	-	-	-	-	-	-	-	-	-	-	-
TA541	-	-	●	-	-	-	-	-	-	-	-	-	-	-	-
TA543	-	○	●	-	-	-	-	-	-	-	-	-	-	-	-
TA561-RTC	●	●	●	●	●	●	●	●	●	-	●	●	●	●	○
TA562-RS	●	●	●	●	●	●	●	●	●	-	●	●	●	●	○
TA562-RS-RTC	●	●	●	●	●	●	●	●	●	-	●	●	●	●	○
TA563-11	-	●	●	-	●	-	-	-	●	-	●	●	●	●	○
TA563-9	-	●	●	-	●	-	-	-	●	-	●	●	●	●	○
TA564-11	-	●	●	-	●	-	-	-	●	-	●	●	●	●	○
TA564-9	-	●	●	-	●	-	-	-	●	-	●	●	●	●	○
TA565-11	-	●	●	-	●	-	-	-	●	-	●	●	●	●	○
TA565-9	-	●	●	-	●	-	-	-	●	-	●	●	●	●	○
TA566	-	●	●	-	-	-	●	●	●	-	●	●	●	●	○
TA570	-	●	●	-	●	-	●	●	-	-	-	-	-	-	-
TA571-SIM	●	●	●	●	●	●	-	-	-	-	-	-	-	-	-
TB511-ARCNET	●	●	●	●	●	●	●	●	●	●	●	●	●	●	○
TB511-ETH	●	●	●	●	●	●	●	●	●	●	●	●	●	●	○
TB511-ETH-XC	●	●	●	●	●	●	●	●	●	●	●	●	●	-	○
TB521-ARCNET	●	●	●	●	●	●	●	●	●	●	●	●	●	●	○
TB521-ETH	●	●	●	●	●	●	●	●	●	●	●	●	●	●	○
TB521-ETH-XC	●	●	●	●	●	●	●	●	●	●	●	●	●	-	○
TB523-2ETH	●	●	●	●	○	○	●	-	●	○	●	●	●	○	○
TB541-ETH	●	●	●	●	●	○	●	●	●	●	●	●	●	●	○
TB541-ETH-XC	●	●	●	●	●	○	●	●	●	●	●	●	●	-	○
TB5600-2ETH	●	●	●	○	○	○	○	○	-	-	-	-	-	-	○
TB5600-2ETH-XC	○	○	○	○	○	○	○	○	-	-	-	-	-	-	○

Symbols and legends: ● Standard product certified; product label wears approval mark when mandatory
 ○ Approval submitted (roadmap available upon request)
 ○ Submission planned (roadmap available upon request)
 – Submission not planned or not applicable for product

Symbol	Approvals							Maritime classification companies							EU
Abbreviation	CE	RoHS	China RoHS	RCM	EAC	KCC	cULus		ABS	BV	DNV GL	LR	RINA	RMRS	EU
Name							Ordinary Locations	Hazardous Locations							Mutual Recognition
TB5610-2ETH	●	●	●	○	○	○	○	○	-	-	-	-	-	-	○
TB5610-2ETH-XC	○	○	○	○	○	○	○	○	-	-	-	-	-	-	○
TB5620-2ETH	●	●	●	○	○	○	●	○	-	-	-	-	-	-	○
TB5620-2ETH-XC	○	○	○	○	○	○	○	○	-	-	-	-	-	-	○
TB5640-2ETH	●	●	●	○	○	○	○	○	-	-	-	-	-	-	○
TB5640-2ETH-XC	○	○	○	○	○	○	○	○	-	-	-	-	-	-	○
TB5660-2ETH	○	○	○	○	○	○	○	○	-	-	-	-	-	-	○
TB5660-2ETH-XC	○	○	○	○	○	○	○	○	-	-	-	-	-	-	○
TF501-CMS	●	●	●	○	○	○	●	●	●	○	●	●	●	○	○
TF501-CMS-XC	●	●	●	○	○	○	●	●	●	○	●	●	●	○	○
TF521-CMS	●	●	●	○	○	○	●	●	●	○	●	●	●	○	○
TF521-CMS-XC	●	●	●	○	○	○	●	●	●	○	●	●	●	○	○
TK501	-	-	●	-	●	-	●	●	●	-	-	-	●	●	-
TK502	-	-	●	-	●	-	●	●	●	-	-	-	●	●	-
TK503	●	●	●	●	●	●	●	●	●	-	●	-	●	●	○
TK504	●	●	●	●	●	●	●	●	●	-	●	●	●	●	○
TK506	●	●	●	●	●	○	●	●	●	-	●	●	●	●	○
TU507-ETH	●	●	●	●	●	●	●	●	●	●	●	●	●	●	○
TU508-ETH	●	●	●	●	●	●	●	●	●	●	●	●	●	●	○
TU508-ETH-XC	●	●	●	●	●	●	●	●	●	●	●	●	●	●	○
TU509	●	●	●	●	●	●	●	●	●	●	●	●	●	●	○
TU510	●	●	●	●	●	●	●	●	●	●	●	●	●	●	○
TU510-XC	●	●	●	●	●	●	●	●	●	●	●	●	●	●	○
TU515	●	●	●	●	●	●	●	●	●	●	●	●	●	●	○
TU516	●	●	●	●	●	●	●	●	●	●	●	●	●	●	○
TU516-H	○	○	○	○	○	○	○	○	-	-	-	-	-	-	○
TU516-H-XC	○	○	○	○	○	○	○	○	-	-	-	-	-	-	○
TU516-XC	●	●	●	●	●	●	●	●	●	●	●	●	●	●	○
TU517	●	●	○	●	●	●	●	●	●	●	●	●	●	●	○
TU518	●	●	○	●	●	●	●	●	●	●	●	●	●	●	○
TU518-XC	●	●	○	●	●	●	●	●	●	●	●	●	●	●	○
TU520-ETH	●	●	○	●	●	●	●	●	●	●	●	●	●	●	○
TU520-ETH-XC	●	●	○	●	●	●	●	●	●	●	●	●	●	●	○
TU531	●	●	●	●	●	●	●	●	●	●	●	●	●	●	○
TU532	●	●	●	●	●	●	●	●	●	●	●	●	●	●	○
TU532-H	○	○	○	○	○	○	○	○	-	-	-	-	-	-	○
TU532-H-XC	○	○	○	○	○	○	○	○	-	-	-	-	-	-	○
TU532-XC	●	●	●	●	●	●	●	●	●	●	●	●	●	●	○
TU541	●	○	○	○	●	●	●	○	●	●	●	●	●	●	○
TU542	●	●	●	●	●	●	●	○	●	●	●	●	●	●	○
TU542-H	○	○	○	○	○	○	○	○	-	-	-	-	-	-	○
TU542-H-XC	○	○	○	○	○	○	○	○	-	-	-	-	-	-	○
TU542-XC	○	○	○	○	○	○	○	○	-	-	-	-	●	-	○
TU551-CS31	●	●	●	●	●	●	●	●	●	●	●	●	●	●	○
TU552-CS31	●	●	●	●	●	●	●	●	●	●	●	●	●	●	○
TU552-CS31-XC	●	●	●	●	●	●	●	●	●	●	●	●	●	●	○
TU582-S	●	●	●	●	●	○	●	●	●	-	●	●	●	●	○
TU582-S-XC	●	●	●	●	●	○	●	●	●	-	●	●	●	●	○

Index

Order code classification

Order code	Type	Page	Order code	Type	Page	Order code	Type	Page
1SAP110300R0278	TB5600-2ETH	81	1SAP172900R0111	CM589-PNIO-4	82	1SAP214000R0001	TU508-ETH	85
1SAP111100R0260	TB511-ARCNET	78	1SAP173200R0001	CM592-DP	82	1SAP214200R0001	TU507-ETH	85
1SAP111100R0270	TB511-ETH	78	1SAP173700R0001	CM597-ETH	82	1SAP214400R0001	TU520-ETH	85
1SAP111300R0278	TB5610-2ETH	81	1SAP173800R0001	CM598-CN	82	1SAP215000R0001	TU516-H	85
1SAP112100R0260	TB521-ARCNET	78	1SAP180100R0001	MC502	60	1SAP215100R0001	TU532-H	85
1SAP112100R0270	TB521-ETH	78	1SAP180100R0001	MC502	87	1SAP215200R0001	TU542-H	85
1SAP112300R0277	TB523-2ETH	78	1SAP180200R0001	TK501	87	1SAP217000R0001	TU532	85
1SAP112300R0278	TB5620-2ETH	81	1SAP180200R0101	TK502	87	1SAP217200R0001	TU531	85
1SAP114100R0270	TB541-ETH	78	1SAP180300R0001	TA521	87	1SAP220500R0001	DC551-CS31	84
1SAP114300R0278	TB5640-2ETH	81	1SAP180500R0001	TA523	87	1SAP220600R0001	CI501-PNIO	84
1SAP116300R0278	TB5660-2ETH	81	1SAP180600R0001	TA524	87	1SAP220700R0001	CI502-PNIO	84
1SAP117000R0271	TF501-CMS	79	1SAP180700R0001	TA525	87	1SAP220900R0001	CI511-ETHCAT	84
1SAP117200R0271	TF521-CMS	79	1SAP180800R0001	TA526	87	1SAP221000R0001	CI512-ETHCAT	84
1SAP120600R0001	PM554-TP	58	1SAP181100R0001	TA527	87	1SAP221100R0001	CI590-CS31-HA	84
1SAP120600R0071	PM554-TP-ETH	58	1SAP181200R0001	TA528	87	1SAP221200R0001	CI592-CS31	84
1SAP120700R0001	PM554-RP	58	1SAP181400R0001	TA561-RTC	60	1SAP221300R0001	CI504-PNIO	85
1SAP120800R0001	PM554-RP-AC	58	1SAP181500R0001	TA562-RS-RTC	60	1SAP221500R0001	CI506-PNIO	85
1SAP120900R0001	PM564-TP	58	1SAP182000R0001	TA532	87	1SAP222100R0001	CI521-MODTCP	84
1SAP120900R0071	PM564-TP-ETH	58	1SAP182100R0001	TA533	87	1SAP222200R0001	CI522-MODTCP	84
1SAP121000R0001	PM564-RP	58	1SAP182200R0001	TA534	87	1SAP224100R0001	CI541-DP	84
1SAP121000R0071	PM564-RP-ETH	58	1SAP182300R0001	TA535	134	1SAP224200R0001	CI542-DP	84
1SAP121100R0001	PM564-RP-AC	58	1SAP182400R0001	TA512-BAS	87	1SAP228100R0001	CI581-CN	84
1SAP121100R0071	PM564-RP-ETH-AC	58	1SAP182500R0001	TA513-ADV	87	1SAP228200R0001	CI582-CN	84
1SAP121200R0071	PM556-TP-ETH	58	1SAP182600R0001	TA540	87	1SAP230500R0000	DI572	59
1SAP121500R0071	PM566-TP-ETH	58	1SAP182700R0001	TA541	87	1SAP230900R0000	DO562	59
1SAP130200R0200	PM572	76	1SAP182800R0001	TA543	87	1SAP231300R0000	DO573	59
1SAP130300R0271	PM573-ETH	76	1SAP182900R0001	TA514-SAFETY	170	1SAP231900R0000	DC562	59
1SAP131000R0278	PM5630-2ETH	80	1SAP183100R0001	TA536	87	1SAP233100R0001	FM562	60
1SAP140200R0201	PM582	76	1SAP186100R0001	TK506	60	1SAP240000R0001	DI524	82
1SAP140300R0271	PM583-ETH	76	1SAP186200R0004	TA574-D-T-ETH	211	1SAP240100R0001	DC532	82
1SAP140500R0271	PM585-ETH	76	1SAP192100R0102	PS552-MC-E	45	1SAP240500R0001	DC523	82
1SAP140500R0379	PM585-MC-KIT	76	1SAP193600R0001	DM-KEY	44	1SAP240600R0001	DC522	82
1SAP140500R0379	PM585-MC-KIT	203	1SAP195000R0101	PS562-SOLAR	45	1SAP240700R0001	DO524	82
1SAP141000R0278	PM5650-2ETH	80	1SAP195400R0101	PS5601-HA-MTCP	45	1SAP240800R0001	DO526	82
1SAP150000R0261	PM590-ARCNET	76	1SAP195400R0101	PS5601-HA-MTCP	80	1SAP245000R0001	DX531	82
1SAP150000R0271	PM590-ETH	76	1SAP195400R0101	PS5601-HA-MTCP	127	1SAP245200R0001	DX522	82
1SAP150000R0379	PM590-MC-KIT	76	1SAP195500R0101	PS565-BACnet-ASC	45	1SAP250000R0001	AX522	83
1SAP150000R0379	PM590-MC-KIT	203	1SAP195600R0101	PS5602-61850	45	1SAP250100R0001	AX521	83
1SAP150100R0271	PM591-ETH	76	1SAP195600R0101	PS5602-61850	80	1SAP250200R0001	AO523	83
1SAP150100R0277	PM591-2ETH	76	1SAP195600R0101	PS5602-61850	127	1SAP250300R0001	AI523	83
1SAP150200R0271	PM592-ETH	76	1SAP195700R0101	PS5603-RTVISU	45	1SAP250600R0001	AI531	83
1SAP151000R0278	PM5670-2ETH	80	1SAP195700R0101	PS5603-RTVISU	80	1SAP250700R0001	DA501	83
1SAP151500R0278	PM5675-2ETH	80	1SAP195700R0101	PS5603-RTVISU	127	1SAP260300R0001	CD522	83
1SAP155500R0279	PM595-4ETH-F	77	1SAP210400R0001	TU552-CS31	85	1SAP260400R0001	FM502-CMS	79
1SAP155500R0279	PM595-4ETH-F	203	1SAP210600R0001	TU551-CS31	85	1SAP270000R0001	DC541-CM	83
1SAP170400R0201	CM574-RS	82	1SAP210800R0001	TU510	85	1SAP280000R0001	SM560-S	170
1SAP170401R0201	CM574-RCOM	82	1SAP211000R0001	TU509	85	1SAP281200R0001	TU582-S	170
1SAP170901R0101	CM579-PNIO	82	1SAP211200R0001	TU518	85	1SAP282000R0001	AI581-S	170
1SAP170902R0101	CM579-ETHCAT	82	1SAP211400R0001	TU517	85	1SAP284000R0001	DI581-S	170
1SAP172200R0001	CM582-DP	82	1SAP212000R0001	TU516	85	1SAP284100R0001	DX581-S	170
1SAP172800R0001	CM588-CN	82	1SAP212200R0001	TU515	85	1SAP286000R0001	SM560-S-FD-1	170
1SAP172900R0011	CM589-PNIO	82	1SAP213200R0001	TU542	85	1SAP286100R0001	SM560-S-FD-4	170

Index

Order code classification

Order code	Type	Page	Order code	Type	Page	Order code	Type	Page
1SAP310300R0278	TB5600-2ETH-XC	128	1SAP424200R0001	CI542-DP-XC	131	1SAP565200R0001	CP665-WEB	184
1SAP311100R0270	TB511-ETH-XC	125	1SAP428100R0001	CI581-CN-XC	131	1SAP576100R0001	CP676	184
1SAP311300R0278	TB5610-2ETH-XC	128	1SAP428200R0001	CI582-CN-XC	131	1SAP576200R0001	CP676-WEB	184
1SAP312100R0270	TB521-ETH-XC	125	1SAP440000R0001	DI524-XC	129	1SAS010000R0102	DM200-TOOL	44
1SAP312300R0278	TB5620-2ETH-XC	128	1SAP440100R0001	DC532-XC	129	1SAS010001R0102	DM201-TOOL-UPGR	44
1SAP314100R0270	TB541-ETH-XC	125	1SAP440500R0001	DC523-XC	129	1SAS010002R0102	DM202-PREM	44
1SAP314300R0278	TB5640-2ETH-XC	128	1SAP440600R0001	DC522-XC	129	1SAS010003R0102	DM203-PREM-UPGR	44
1SAP316300R0278	TB5660-2ETH-XC	128	1SAP440700R0001	DO524-XC	129	1SAS010007R0102	DM207-PVC	44
1SAP317000R0271	TF501-CMS-XC	126	1SAP440800R0001	DO526-XC	129	1SAS010014R0102	DM214-PVC-NW	44
1SAP317200R0271	TF521-CMS-XC	126	1SAP445200R0001	DX522-XC	129	1SAS010020R0102	DM220-FSE	44
1SAP330300R0271	PM573-ETH-XC	124	1SAP450000R0001	AX522-XC	130	1SAS010021R0102	DM221-FSE-NW	44
1SAP331000R0278	PM5630-2ETH-XC	127	1SAP450100R0001	AX521-XC	130	1SAS010050R0102	DM250-VCP	44
1SAP340200R0201	PM582-XC	124	1SAP450200R0001	AO523-XC	130	1SAS010051R0102	DM251-VCP-NW	44
1SAP340300R0271	PM583-ETH-XC	124	1SAP450300R0001	AI523-XC	130	1SAS030000R0101	PS563-WATER	45
1SAP341000R0278	PM5650-2ETH-XC	127	1SAP450600R0001	AI531-XC	130	1SAS030010R0101	PS564-TEMPCTRL	45
1SAP350100R0271	PM591-ETH-XC	124	1SAP450700R0001	DA501-XC	130	1TNE968901R0100	MC503	60
1SAP350200R0271	PM592-ETH-XC	124	1SAP460300R0001	CD522-XC	130	1TNE968901R1100	TK503	60
1SAP351000R0278	PM5670-2ETH-XC	127	1SAP460400R0001	FM502-CMS-XC	126	1TNE968901R2100	TK504	60
1SAP351500R0278	PM5675-2ETH-XC	127	1SAP470000R0001	DC541-CM-XC	130	1TNE968901R3101	TA563-9	61
1SAP351500R0279	PM595-4ETH-M-XC	124	1SAP481200R0001	TU582-S-XC	171	1TNE968901R3102	TA563-11	61
1SAP370901R0101	CM579-PNIO-XC	129	1SAP482000R0001	AI581-S-XC	171	1TNE968901R3103	TA564-9	61
1SAP372200R0001	CM582-DP-XC	129	1SAP484000R0001	DI581-S-XC	171	1TNE968901R3104	TA564-11	61
1SAP372800R0001	CM588-CN-XC	129	1SAP484100R0001	DX581-S-XC	171	1TNE968901R3105	TA565-9	61
1SAP372900R0011	CM589-PNIO-XC	129	1SAP500900R0101	PB610	186	1TNE968901R3106	TA565-11	61
1SAP372900R0111	CM589-PNIO-4-XC	129	1SAP500901R0101	PB610-R	186	1TNE968901R3107	TA566	60
1SAP373200R0001	CM592-DP-XC	129	1SAP500981R0001	TK681	186	1TNE968901R3203	TA570	60
1SAP373700R0001	CM597-ETH-XC	129	1SAP500982R0001	TK682	186	1TNE968901R4300	TA562-RS	60
1SAP373800R0001	CM598-CN-XC	129	1SAP504100R0001	CP604	184	1TNE968902R1101	AI561	59
1SAP380000R0001	SM560-S-XC	171	1SAP504100R2001	CP604-B	184	1TNE968902R1102	AI562	59
1SAP386000R0001	SM560-S-FD-1-XC	171	1SAP507100R0001	CP607	184	1TNE968902R1103	AI563	59
1SAP386100R0001	SM560-S-FD-4-XC	171	1SAP507100R2001	CP607-B	184	1TNE968902R1201	AO561	59
1SAP410400R0001	TU552-CS31-XC	132	1SAP510100R0001	CP610	184	1TNE968902R1301	AX561	59
1SAP410800R0001	TU510-XC	132	1SAP510100R2001	CP610-B	184	1TNE968902R2001	DC561	59
1SAP411200R0001	TU518-XC	132	1SAP520100R0001	CP620	184	1TNE968902R2101	DI561	59
1SAP412000R0001	TU516-XC	132	1SAP520200R0001	CP620-WEB	184	1TNE968902R2102	DI562	59
1SAP413200R0001	TU542-XC	132	1SAP530100R0001	CP630	184	1TNE968902R2103	DI571	59
1SAP414000R0001	TU508-ETH-XC	132	1SAP530200R0001	CP630-WEB	184	1TNE968902R2201	DO561	59
1SAP414400R0001	TU520-ETH-XC	132	1SAP535100R0001	CP635	184	1TNE968902R2202	DO571	59
1SAP415000R0001	TU516-H-XC	132	1SAP535100R2001	CP635-B	184	1TNE968902R2203	DO572	59
1SAP415100R0001	TU532-H-XC	132	1SAP535110R1001	CP635-FW	186	1TNE968902R2301	DX561	59
1SAP415200R0001	TU542-H-XC	132	1SAP535110R6001	CP635-FB	186	1TNE968902R2302	DX571	59
1SAP417000R0001	TU532-XC	132	1SAP535200R0001	CP635-WEB	184	1TNE968903R0203	TA571-SIM	60
1SAP420500R0001	DC551-CS31-XC	131	1SAP551100R0001	CP651	184			
1SAP420600R0001	CI501-PNIO-XC	131	1SAP551200R0001	CP651-WEB	184			
1SAP420700R0001	CI502-PNIO-XC	131	1SAP560510R0001	CP6605	185			
1SAP421100R0001	CI590-CS31-HA-XC	131	1SAP560710R0001	CP6607	185			
1SAP421200R0001	CI592-CS31-XC	131	1SAP561010R0001	CP6610	185			
1SAP421300R0001	CI504-PNIO-XC	131	1SAP561100R0001	CP661	184			
1SAP421500R0001	CI506-PNIO-XC	131	1SAP561200R0001	CP661-WEB	184			
1SAP422100R0001	CI521-MODTCP-XC	131	1SAP561510R0001	CP6615	185			
1SAP422200R0001	CI522-MODTCP-XC	131	1SAP562110R0001	CP6621	185			
1SAP424100R0001	CI541-DP-XC	131	1SAP565100R0001	CP665	184			

Index

Type classification

Type	Order code	Page
AI523	1SAP250300R0001	83
AI523-XC	1SAP450300R0001	130
AI531	1SAP250600R0001	83
AI531-XC	1SAP450600R0001	130
AI561	1TNE968902R1101	59
AI562	1TNE968902R1102	59
AI563	1TNE968902R1103	59
AI581-S	1SAP282000R0001	170
AI581-S-XC	1SAP482000R0001	171
AO523	1SAP250200R0001	83
AO523-XC	1SAP450200R0001	130
AO561	1TNE968902R1201	59
AX521	1SAP250100R0001	83
AX521-XC	1SAP450100R0001	130
AX522	1SAP250000R0001	83
AX522-XC	1SAP450000R0001	130
AX561	1TNE968902R1301	59
CD522	1SAP260300R0001	83
CD522-XC	1SAP460300R0001	130
CI501-PNIO	1SAP220600R0001	84
CI501-PNIO-XC	1SAP420600R0001	131
CI502-PNIO	1SAP220700R0001	84
CI502-PNIO-XC	1SAP420700R0001	131
CI504-PNIO	1SAP221300R0001	85
CI504-PNIO-XC	1SAP421300R0001	131
CI506-PNIO	1SAP221500R0001	85
CI506-PNIO-XC	1SAP421500R0001	131
CI511-ETHCAT	1SAP220900R0001	84
CI512-ETHCAT	1SAP221000R0001	84
CI521-MODTCP	1SAP222100R0001	84
CI521-MODTCP-XC	1SAP422100R0001	131
CI522-MODTCP	1SAP222200R0001	84
CI522-MODTCP-XC	1SAP422200R0001	131
CI541-DP	1SAP224100R0001	84
CI541-DP-XC	1SAP424100R0001	131
CI542-DP	1SAP224200R0001	84
CI542-DP-XC	1SAP424200R0001	131
CI581-CN	1SAP228100R0001	84
CI581-CN-XC	1SAP428100R0001	131
CI582-CN	1SAP228200R0001	84
CI582-CN-XC	1SAP428200R0001	131
CI590-CS31-HA	1SAP221100R0001	84
CI590-CS31-HA-XC	1SAP421100R0001	131
CI592-CS31	1SAP221200R0001	84
CI592-CS31-XC	1SAP421200R0001	131
CM574-RCOM	1SAP170401R0201	82
CM574-RS	1SAP170400R0201	82
CM579-ETHCAT	1SAP170902R0101	82
CM579-PNIO	1SAP170901R0101	82
CM579-PNIO-XC	1SAP370901R0101	129
CM582-DP	1SAP172200R0001	82
CM582-DP-XC	1SAP372200R0001	129

Type	Order code	Page
CM588-CN	1SAP172800R0001	82
CM588-CN-XC	1SAP372800R0001	129
CM589-PNIO	1SAP172900R0011	82
CM589-PNIO-4	1SAP172900R0111	82
CM589-PNIO-4-XC	1SAP372900R0111	129
CM589-PNIO-XC	1SAP372900R0011	129
CM592-DP	1SAP173200R0001	82
CM592-DP-XC	1SAP373200R0001	129
CM597-ETH	1SAP173700R0001	82
CM597-ETH-XC	1SAP373700R0001	129
CM598-CN	1SAP173800R0001	82
CM598-CN-XC	1SAP373800R0001	129
CP604	1SAP504100R0001	184
CP604-B	1SAP504100R2001	184
CP607	1SAP507100R0001	184
CP607-B	1SAP507100R2001	184
CP610	1SAP510100R0001	184
CP610-B	1SAP510100R2001	184
CP620	1SAP520100R0001	184
CP620-WEB	1SAP520200R0001	184
CP630	1SAP530100R0001	184
CP630-WEB	1SAP530200R0001	184
CP635	1SAP535100R0001	184
CP635-B	1SAP535100R2001	184
CP635-FB	1SAP535110R6001	186
CP635-FW	1SAP535110R1001	186
CP635-WEB	1SAP535200R0001	184
CP651	1SAP551100R0001	184
CP651-WEB	1SAP551200R0001	184
CP6605	1SAP560510R0001	185
CP6607	1SAP560710R0001	185
CP661	1SAP561100R0001	184
CP6610	1SAP561010R0001	185
CP6615	1SAP561510R0001	185
CP661-WEB	1SAP561200R0001	184
CP6621	1SAP562110R0001	185
CP665	1SAP565100R0001	184
CP665-WEB	1SAP565200R0001	184
CP676	1SAP576100R0001	184
CP676-WEB	1SAP576200R0001	184
DA501	1SAP250700R0001	83
DA501-XC	1SAP450700R0001	130
DC522	1SAP240600R0001	82
DC522-XC	1SAP440600R0001	129
DC523	1SAP240500R0001	82
DC523-XC	1SAP440500R0001	129
DC532	1SAP240100R0001	82
DC532-XC	1SAP440100R0001	129
DC541-CM	1SAP270000R0001	83
DC541-CM-XC	1SAP470000R0001	130
DC551-CS31	1SAP220500R0001	84
DC551-CS31-XC	1SAP420500R0001	131

Type	Order code	Page
DC561	1TNE968902R2001	59
DC562	1SAP231900R0000	59
DI524	1SAP240000R0001	82
DI524-XC	1SAP440000R0001	129
DI561	1TNE968902R2101	59
DI562	1TNE968902R2102	59
DI571	1TNE968902R2103	59
DI572	1SAP230500R0000	59
DI581-S	1SAP284000R0001	170
DI581-S-XC	1SAP484000R0001	171
DM200-TOOL	1SAS010000R0102	44
DM201-TOOL-UPGR	1SAS010001R0102	44
DM202-PREM	1SAS010002R0102	44
DM203-PREM-UPGR	1SAS010003R0102	44
DM207-PVC	1SAS010007R0102	44
DM214-PVC-NW	1SAS010014R0102	44
DM220-FSE	1SAS010020R0102	44
DM221-FSE-NW	1SAS010021R0102	44
DM250-VCP	1SAS010050R0102	44
DM251-VCP-NW	1SAS010051R0102	44
DM-KEY	1SAP193600R0001	44
DO524	1SAP240700R0001	82
DO524-XC	1SAP440700R0001	129
DO526	1SAP240800R0001	82
DO526-XC	1SAP440800R0001	129
DO561	1TNE968902R2201	59
DO562	1SAP230900R0000	59
DO571	1TNE968902R2202	59
DO572	1TNE968902R2203	59
DO573	1SAP231300R0000	59
DX522	1SAP245200R0001	82
DX522-XC	1SAP445200R0001	129
DX531	1SAP245000R0001	82
DX561	1TNE968902R2301	59
DX571	1TNE968902R2302	59
DX581-S	1SAP284100R0001	170
DX581-S-XC	1SAP484100R0001	171
FM502-CMS	1SAP260400R0001	79
FM502-CMS-XC	1SAP460400R0001	126
FM562	1SAP233100R0001	60
MC502	1SAP180100R0001	60
MC502	1SAP180100R0001	87
MC503	1TNE968901R0100	60
PB610	1SAP500900R0101	186
PB610-R	1SAP500901R0101	186
PM554-RP	1SAP120700R0001	58
PM554-RP-AC	1SAP120800R0001	58
PM554-TP	1SAP120600R0001	58
PM554-TP-ETH	1SAP120600R0071	58
PM556-TP-ETH	1SAP121200R0071	58
PM5630-2ETH	1SAP131000R0278	80
PM5630-2ETH-XC	1SAP331000R0278	127

Index

Type classification

Type	Order code	Page	Type	Order code	Page	Type	Order code	Page
PM564-RP	1SAP121000R0001	58	SM560-S-FD-4	1SAP286100R0001	170	TB5660-2ETH-XC	1SAP316300R0278	128
PM564-RP-AC	1SAP121100R0001	58	SM560-S-FD-4-XC	1SAP386100R0001	171	TF501-CMS	1SAP117000R0271	79
PM564-RP-ETH	1SAP121000R0071	58	SM560-S-XC	1SAP380000R0001	171	TF501-CMS-XC	1SAP317000R0271	126
PM564-RP-ETH-AC	1SAP121100R0071	58	TA512-BAS	1SAP182400R0001	87	TF521-CMS	1SAP117200R0271	79
PM564-TP	1SAP120900R0001	58	TA513-ADV	1SAP182500R0001	87	TF521-CMS-XC	1SAP317200R0271	126
PM564-TP-ETH	1SAP120900R0071	58	TA514-SAFETY	1SAP182900R0001	170	TK501	1SAP180200R0001	87
PM5650-2ETH	1SAP141000R0278	80	TA521	1SAP180300R0001	87	TK502	1SAP180200R0101	87
PM5650-2ETH-XC	1SAP341000R0278	127	TA523	1SAP180500R0001	87	TK503	1TNE968901R1100	60
PM566-TP-ETH	1SAP121500R0071	58	TA524	1SAP180600R0001	87	TK504	1TNE968901R2100	60
PM5670-2ETH	1SAP151000R0278	80	TA525	1SAP180700R0001	87	TK506	1SAP186100R0001	60
PM5670-2ETH-XC	1SAP351000R0278	127	TA526	1SAP180800R0001	87	TK681	1SAP500981R0001	186
PM5675-2ETH	1SAP151500R0278	80	TA527	1SAP181100R0001	87	TK682	1SAP500982R0001	186
PM5675-2ETH-XC	1SAP351500R0278	127	TA528	1SAP181200R0001	87	TU507-ETH	1SAP214200R0001	85
PM572	1SAP130200R0200	76	TA532	1SAP182000R0001	87	TU508-ETH	1SAP214000R0001	85
PM573-ETH	1SAP130300R0271	76	TA533	1SAP182100R0001	87	TU508-ETH-XC	1SAP414000R0001	132
PM573-ETH-XC	1SAP330300R0271	124	TA534	1SAP182200R0001	87	TU509	1SAP211000R0001	85
PM582	1SAP140200R0201	76	TA535	1SAP182300R0001	134	TU510	1SAP210800R0001	85
PM582-XC	1SAP340200R0201	124	TA536	1SAP183100R0001	87	TU510-XC	1SAP410800R0001	132
PM583-ETH	1SAP140300R0271	76	TA540	1SAP182600R0001	87	TU515	1SAP212200R0001	85
PM583-ETH-XC	1SAP340300R0271	124	TA541	1SAP182700R0001	87	TU516	1SAP212000R0001	85
PM585-ETH	1SAP140500R0271	76	TA543	1SAP182800R0001	87	TU516-H	1SAP215000R0001	85
PM585-MC-KIT	1SAP140500R0379	76	TA561-RTC	1SAP181400R0001	60	TU516-H-XC	1SAP415000R0001	132
PM585-MC-KIT	1SAP140500R0379	203	TA562-RS	1TNE968901R4300	60	TU516-XC	1SAP412000R0001	132
PM590-ARCNET	1SAP150000R0261	76	TA562-RS-RTC	1SAP181500R0001	60	TU517	1SAP211400R0001	85
PM590-ETH	1SAP150000R0271	76	TA563-11	1TNE968901R3102	61	TU518	1SAP211200R0001	85
PM590-MC-KIT	1SAP150000R0379	76	TA563-9	1TNE968901R3101	61	TU518-XC	1SAP411200R0001	132
PM590-MC-KIT	1SAP150000R0379	203	TA564-11	1TNE968901R3104	61	TU520-ETH	1SAP214400R0001	85
PM591-2ETH	1SAP150100R0277	76	TA564-9	1TNE968901R3103	61	TU520-ETH-XC	1SAP414400R0001	132
PM591-ETH	1SAP150100R0271	76	TA565-11	1TNE968901R3106	61	TU531	1SAP217200R0001	85
PM591-ETH-XC	1SAP350100R0271	124	TA565-9	1TNE968901R3105	61	TU532	1SAP217000R0001	85
PM592-ETH	1SAP150200R0271	76	TA566	1TNE968901R3107	60	TU532-H	1SAP215100R0001	85
PM592-ETH-XC	1SAP350200R0271	124	TA570	1TNE968901R3203	60	TU532-H-XC	1SAP415100R0001	132
PM595-4ETH-F	1SAP155500R0279	77	TA571-SIM	1TNE968903R0203	60	TU532-XC	1SAP417000R0001	132
PM595-4ETH-F	1SAP155500R0279	203	TA574-D-T-ETH	1SAP186200R0004	211	TU542	1SAP213200R0001	85
PM595-4ETH-M-XC	1SAP351500R0279	124	TB511-ARCNET	1SAP111100R0260	78	TU542-H	1SAP215200R0001	85
PS552-MC-E	1SAP192100R0102	45	TB511-ETH	1SAP111100R0270	78	TU542-H-XC	1SAP415200R0001	132
PS5601-HA-MTCP	1SAP195400R0101	45	TB511-ETH-XC	1SAP311100R0270	125	TU542-XC	1SAP413200R0001	132
PS5601-HA-MTCP	1SAP195400R0101	80	TB521-ARCNET	1SAP112100R0260	78	TU551-CS31	1SAP210600R0001	85
PS5601-HA-MTCP	1SAP195400R0101	127	TB521-ETH	1SAP112100R0270	78	TU552-CS31	1SAP210400R0001	85
PS5602-61850	1SAP195600R0101	45	TB521-ETH-XC	1SAP312100R0270	125	TU552-CS31-XC	1SAP410400R0001	132
PS5602-61850	1SAP195600R0101	80	TB523-2ETH	1SAP112300R0277	78	TU582-S	1SAP281200R0001	170
PS5602-61850	1SAP195600R0101	127	TB541-ETH	1SAP114100R0270	78	TU582-S-XC	1SAP481200R0001	171
PS5603-RTVISU	1SAP195700R0101	45	TB541-ETH-XC	1SAP314100R0270	125			
PS5603-RTVISU	1SAP195700R0101	80	TB5600-2ETH	1SAP110300R0278	81			
PS5603-RTVISU	1SAP195700R0101	127	TB5600-2ETH-XC	1SAP310300R0278	128			
PS562-SOLAR	1SAP195000R0101	45	TB5610-2ETH	1SAP111300R0278	81			
PS563-WATER	1SAS030000R0101	45	TB5610-2ETH-XC	1SAP311300R0278	128			
PS564-TEMPCTRL	1SAS030010R0101	45	TB5620-2ETH	1SAP112300R0278	81			
PS565-BACnet-ASC	1SAP195500R0101	45	TB5620-2ETH-XC	1SAP312300R0278	128			
SM560-S	1SAP280000R0001	170	TB5640-2ETH	1SAP114300R0278	81			
SM560-S-FD-1	1SAP286000R0001	170	TB5640-2ETH-XC	1SAP314300R0278	128			
SM560-S-FD-1-XC	1SAP386000R0001	171	TB5660-2ETH	1SAP116300R0278	81			

Additional information

We reserve the right to make technical changes or modify the contents of this document without prior notice. ABB does not accept any responsibility whatsoever for potential errors or possible lack of information in this document.

We reserve all rights in this document and in the subject matter and illustrations contained therein. Any reproduction, disclosure to third parties or utilization of its contents – in whole or in parts – is forbidden without prior written consent of ABB.

ABB Automation Products GmbH

Eppelheimer Straße 82
D-69123 Heidelberg / Germany
Tel.: +49 62 21 701 1444
Fax: +49 62 21 701 1382



www.abb.com/plc



www.abb.com/automationbuilder